

Seagull Sailor



Cut out the parts, and then carefully follow the assembly instructions.

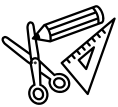

Tools & Materials

- Scissors, utility knife
- Glue stick and wood glue
- Ruler or set square
- Pencil
- Object with pointed tip (dried-up ballpoint pen, stencil pen, etc.)
- Toothpicks
- Tweezers



Tips for Assembly

- Keep track of which part is which by writing each part's number in pencil on the back of the part.
- Use a dried-up ballpoint pen, stencil pen, or other pointed object and a ruler to score along the fold lines. This will create sharper, neater folds.
- Before gluing, fold and crease along the fold lines and add curves where needed.
- Use a toothpick when applying glue. Thinly applied glue gives a neater finish.
- Use tweezers when picking up and attaching small parts.



















Caution

- This paper craft uses scissors, utility knives, glue, and other items and materials which may be dangerous to children. Keep these items and materials out of reach of children while you work.
- Take care not to injure yourself when using scissors, utility knives, and other sharp or pointed objects.



Symbols and Notation

	Pattern		Apply glue (red arrow)
	Assembly instructions		Insert (blue arrow) (Do not apply glue)
(1), (2), (3)...	Part numbers		Add curves
	Mountain fold line (dotted line)		Dots on glue tabs show where and how to glue parts together.
	Valley fold line (dotted & dashed line)		Glue tab (red dot) Glue one part to another part
	Cut line (solid line)		Glue tab (green dot) Glue one place to another on the same part
	Partial cut line (solid red line)		Glue tab (blue dot) Glue one part to the reverse of another part
	Cut-out area		Glue tab (yellow dot) Glue the reverse of two parts together

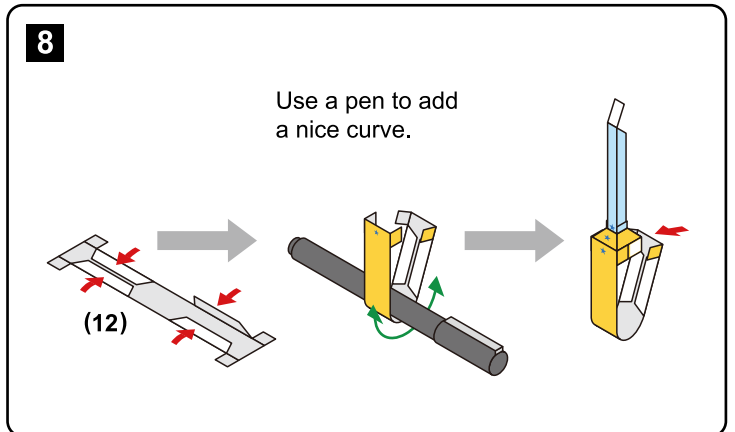
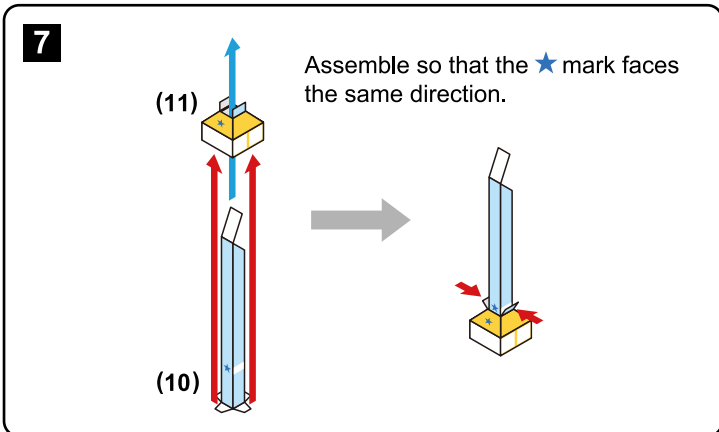
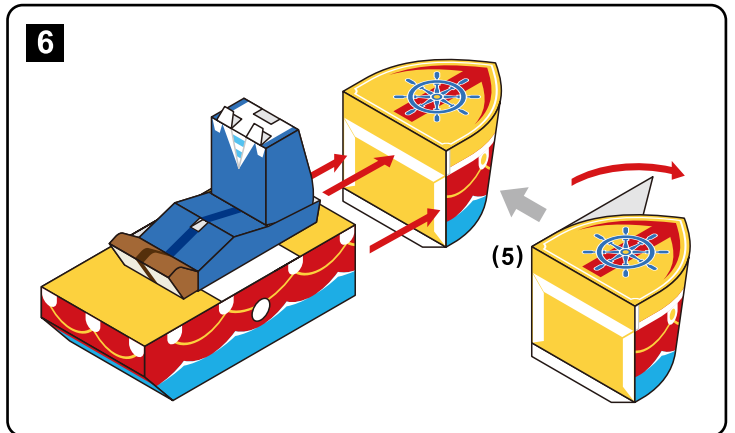
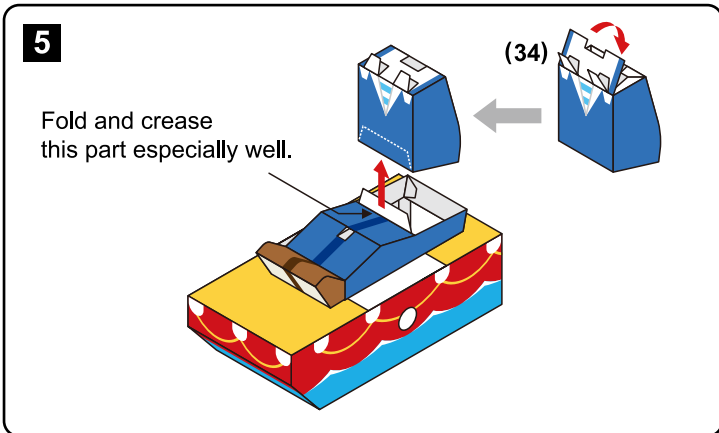
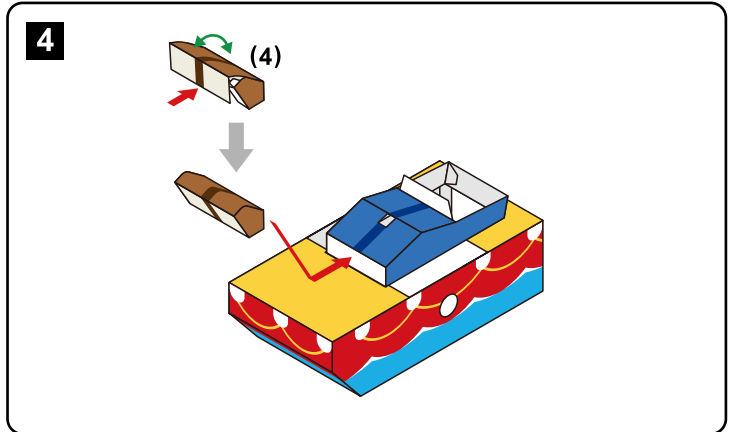
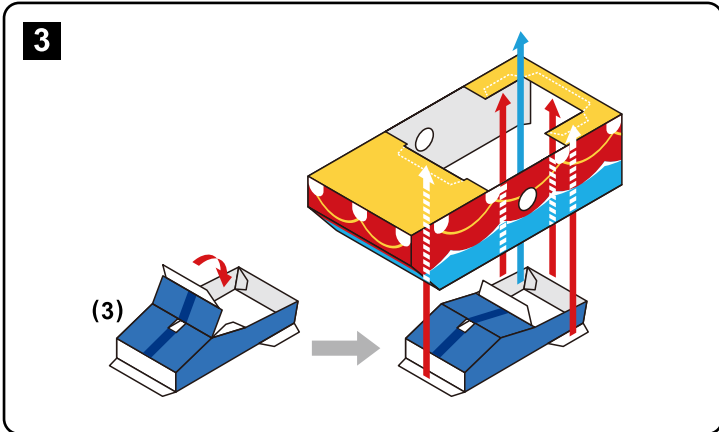
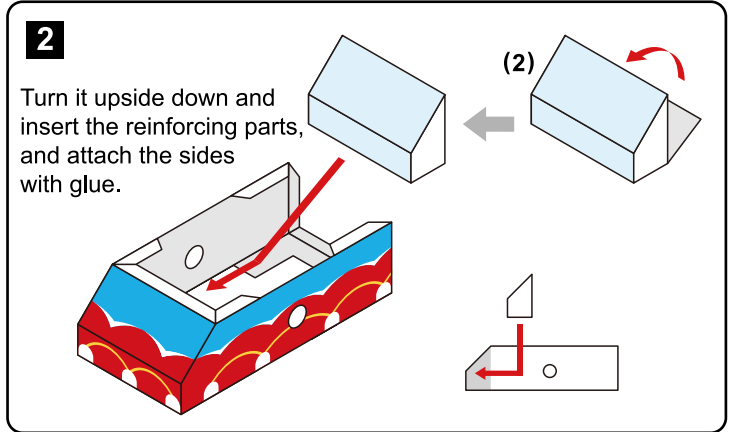
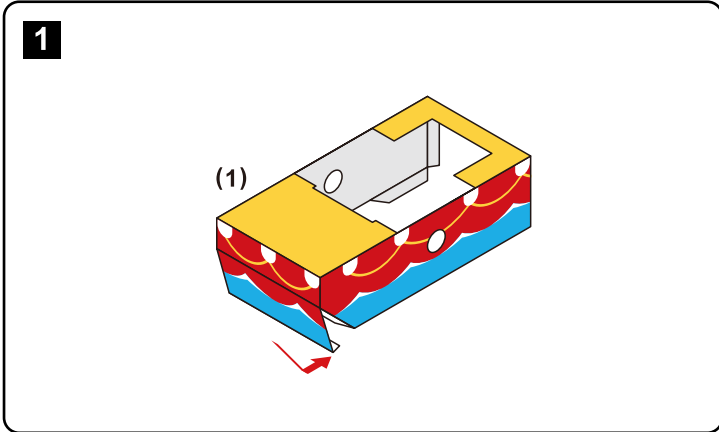



9

Assemble so that the same colored triangles face each other.

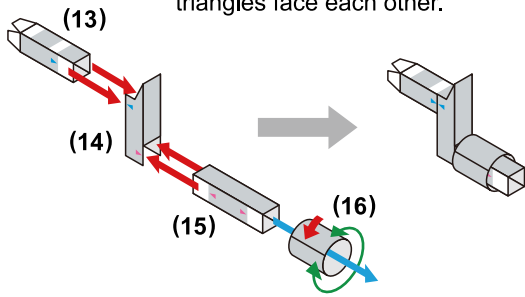

10

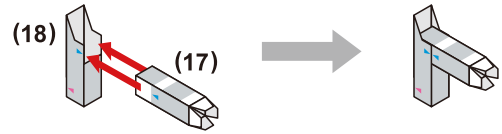

11

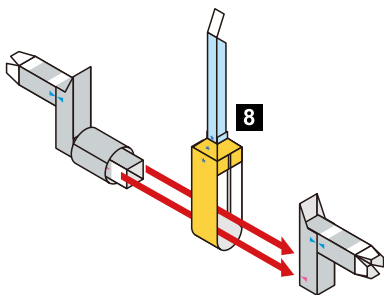

12

Assemble so that the triangles face each other.

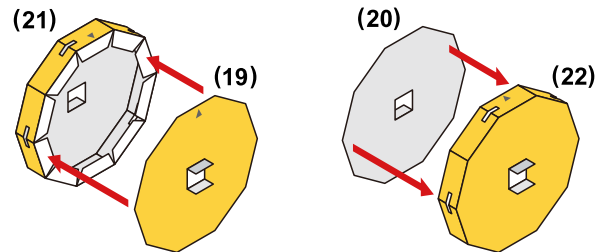

13

Be careful that the tires are not crooked.

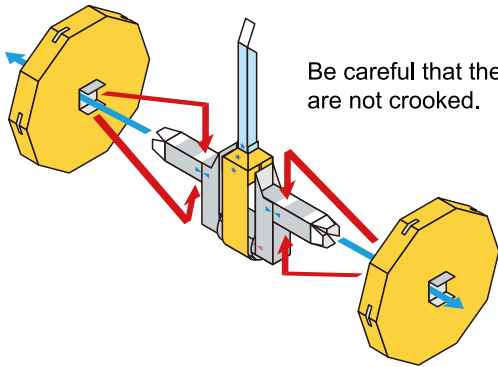

14

Put a rubber band around each tire, insert them into the grooves and fix them into place.

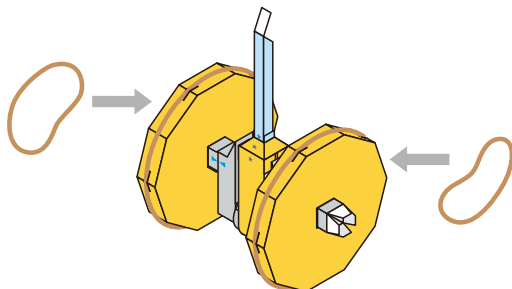

15

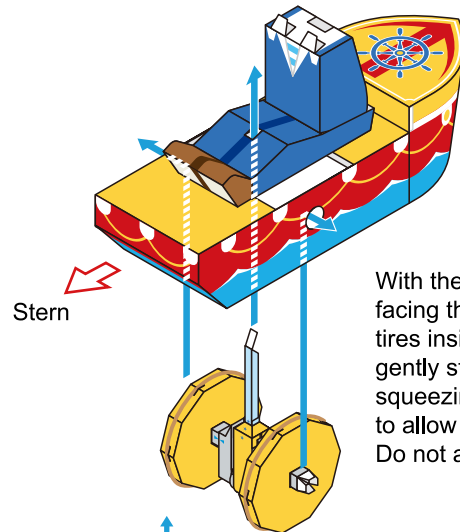

With the parts marked ★ facing the stern, fit the tires inside the boat, gently stretching and squeezing the boat to allow them inside. Do not apply glue.

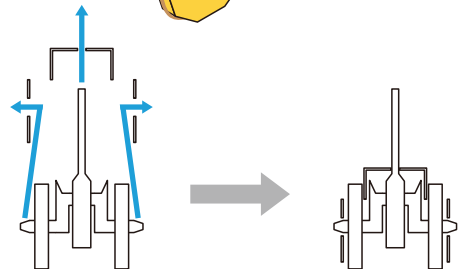

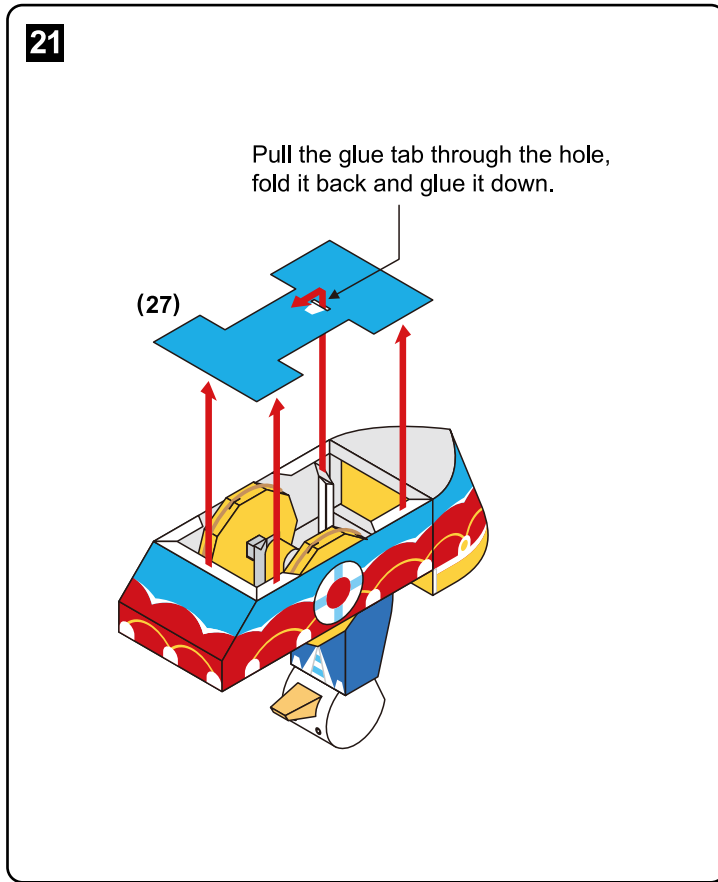
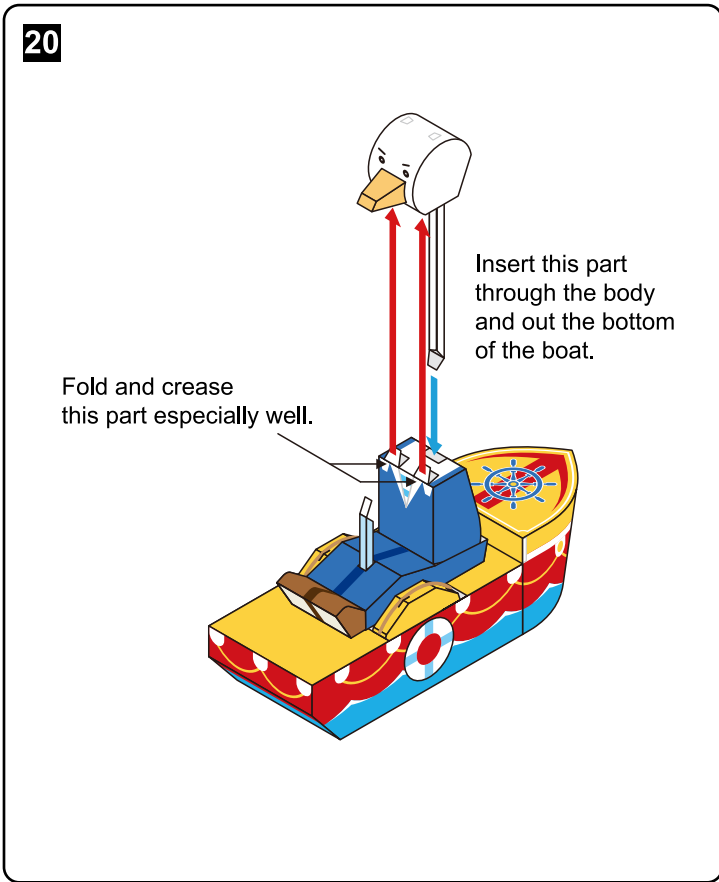
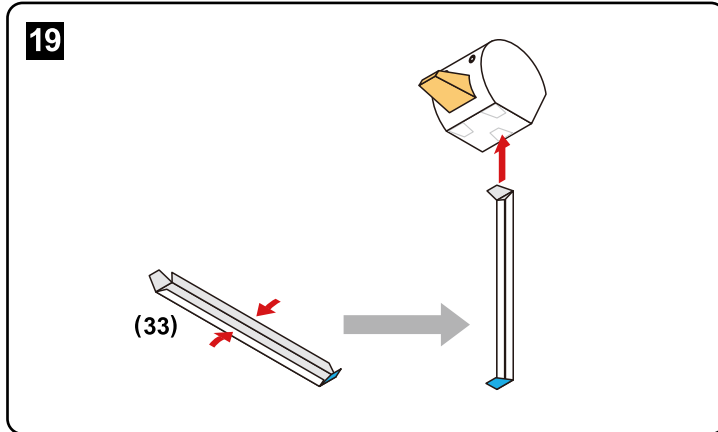
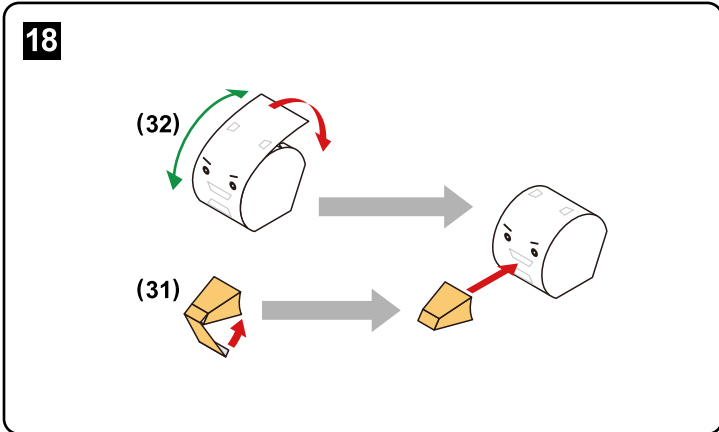
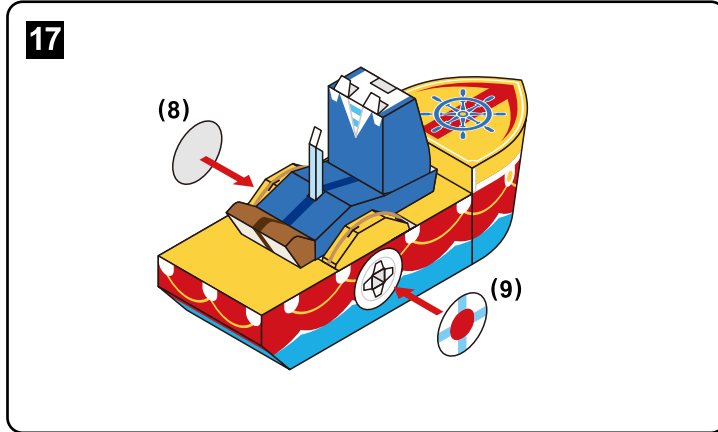
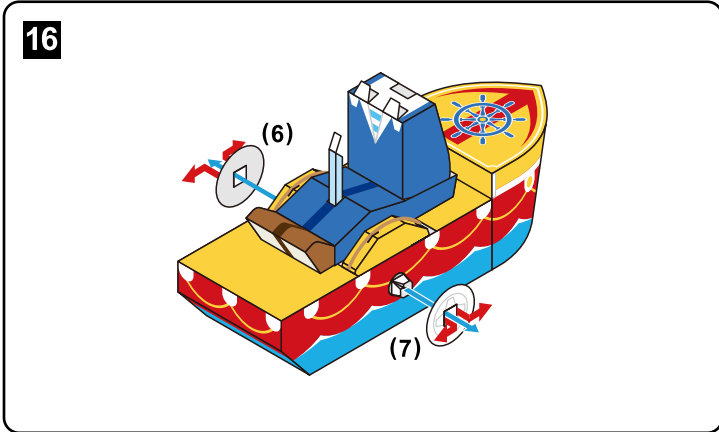



22

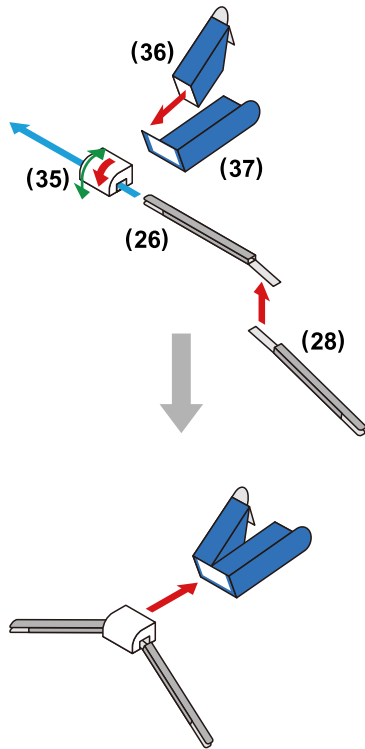

23

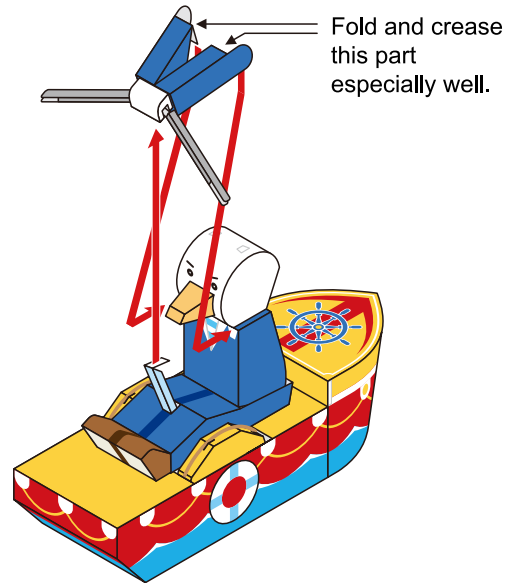

24

Insert the oar handles through the holes, and glue this part down.

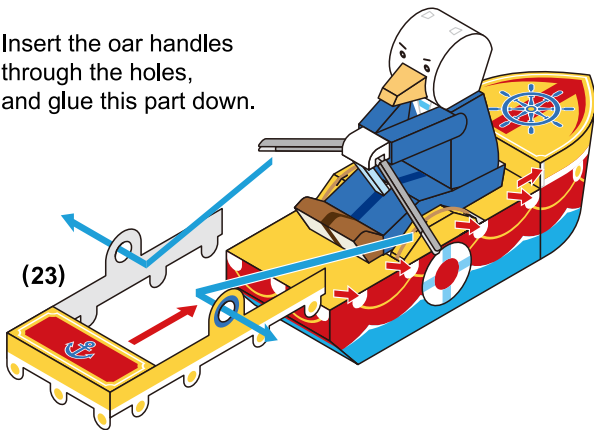

25

Attach the hat and the oar paddles, and you're done! Put the boat on a table or the floor, hold the part of the boat shown in the picture, and push it in the direction of the arrow.

