



PAPER CRAFT

<http://www.canon.com/c-park/en/>



View of completed model

* This model was designed for Papercraft and may differ from the original in some respects.

■ Assembly Instructions : Six A4 sheets (No. 1 to No. 6)

* Build the model by carefully reading the Assembly Instructions , in the parts sheet page order.

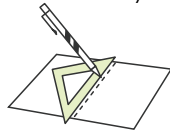

*Hint: Trace along the folds with a ruler and an exhausted pen (no ink) to get a sharper, easier fold.

Assembly Instructions



Mountain fold(dotted line)
Make a mountain fold.



Valley fold(dashed and dotted line)
Make a valley fold.



Scissors line(solid line)
Cut along the line.



Cut in line(solid line)
Cut along the line.

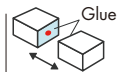

Glue
The glue spot(colored dot) shows where to apply the glue.

● **Glue spot(Red dot)**
Glue parts with the same number together.

● **Glue spot(Green dot)**
Glue within the same part.

● **Glue spot(Blue dot)**
Glue to the rear of the other part.

Tools and materials



Scissors, set square, glue(We recommend stick glue), pencil, used ballpoint pen, toothpicks, tweezers, (useful for handling small parts)

Assembly tip



Before gluing, crease the paper along mountain fold and valley fold lines and make sure rounded sections are nice and stiff.

Caution



Glue, scissors and other tools may be dangerous to young children so be sure to keep them out of the reach of young children.

Before starting assembly :

- Writing the number of each section on its back side before cutting out the sections is highly recommended. (* This way, you can be sure which section is which even after cutting out the sections.)
- The parts used will vary somewhat, depending on whether the completed vessel will be modeled to depict a ship facing wind from the left (with the bow pointed to the right) or from the right (with the bow pointed to the left). First decide where you want to display the completed vessel, then decide whether the bow should point to the left or right.

Bow pointed to the right (A - standard parts)

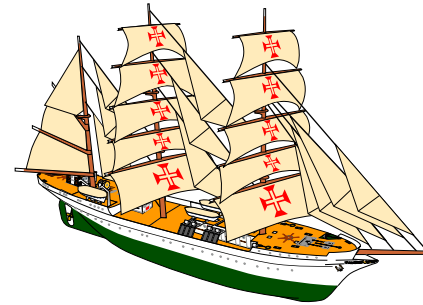

Bow pointed to the left (B - optional parts)

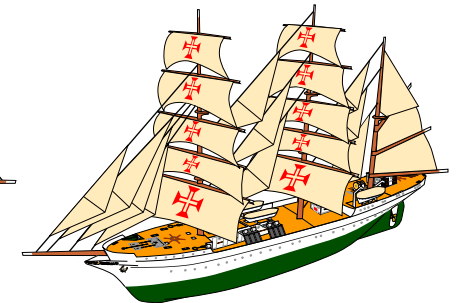

→ Indicates where sections should be glued together.

■ Indicates sections that should be glued first, then cut out.

→ Indicates where to insert sections. Do not glue the sections together.

■ Indicates sections that should be folded once, then unfolded.

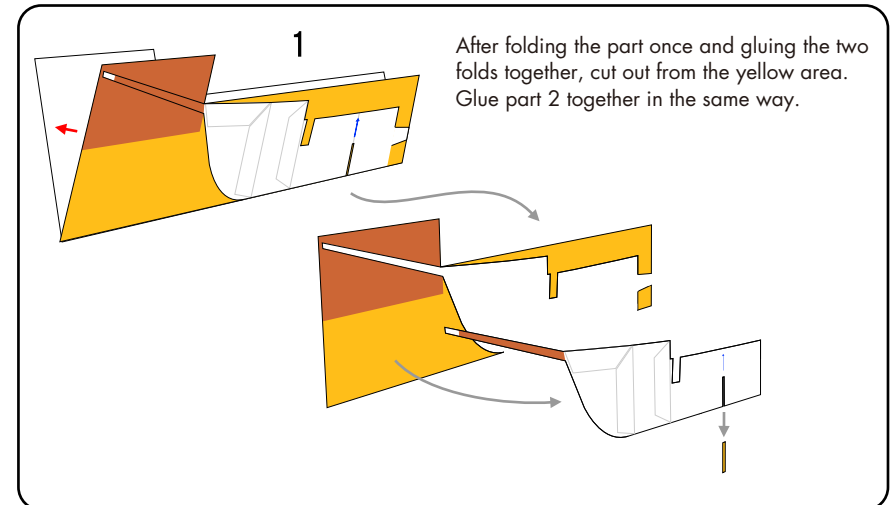



Part 15-A (bow pointed to the right) or **15-B** (bow pointed to the left; optional part)
After folding this part, unfold and cut out from the cream-colored area.

Parts 16, 25, 29
Glue the rear sides of these parts together.

Insert until the corners meet.

Curl part 18 by wrapping it around a thin stick (such as a toothpick).

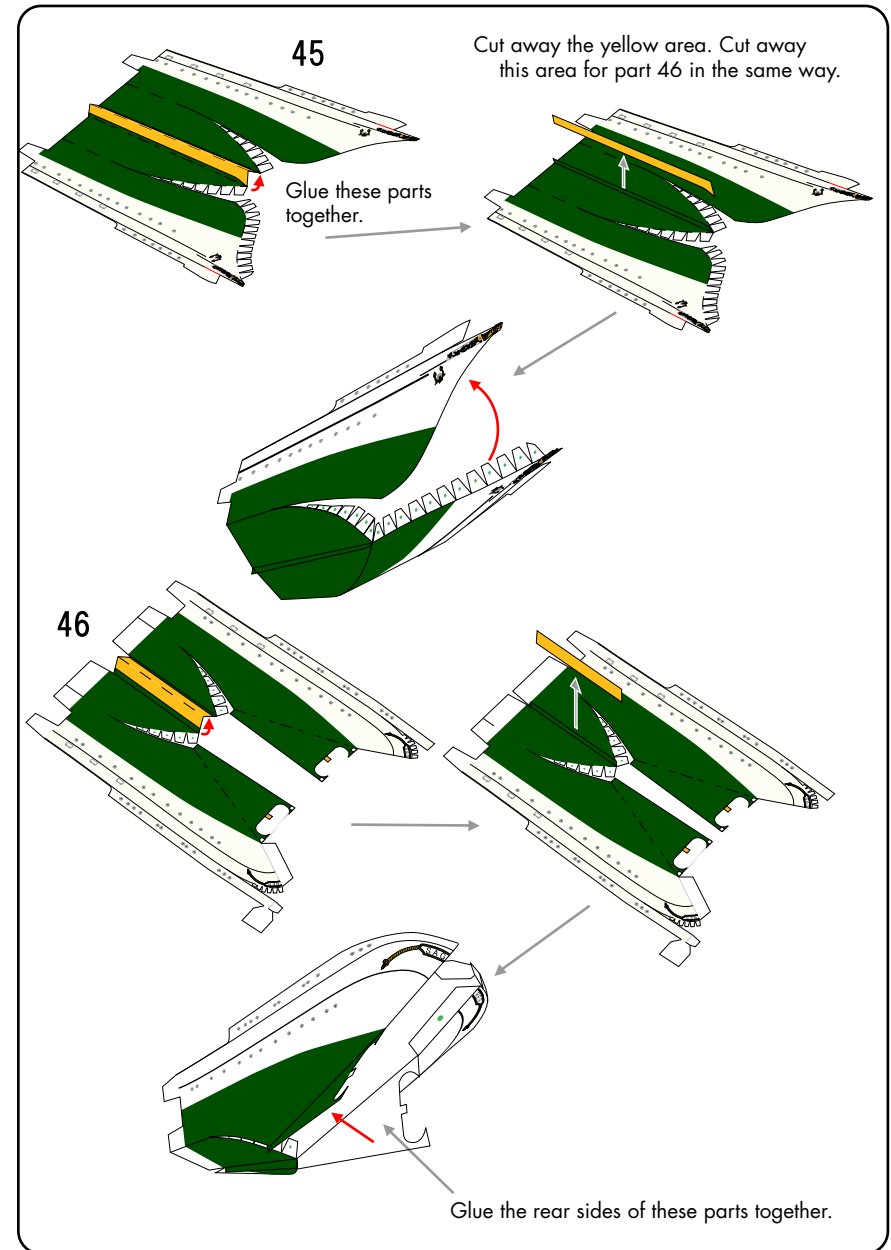
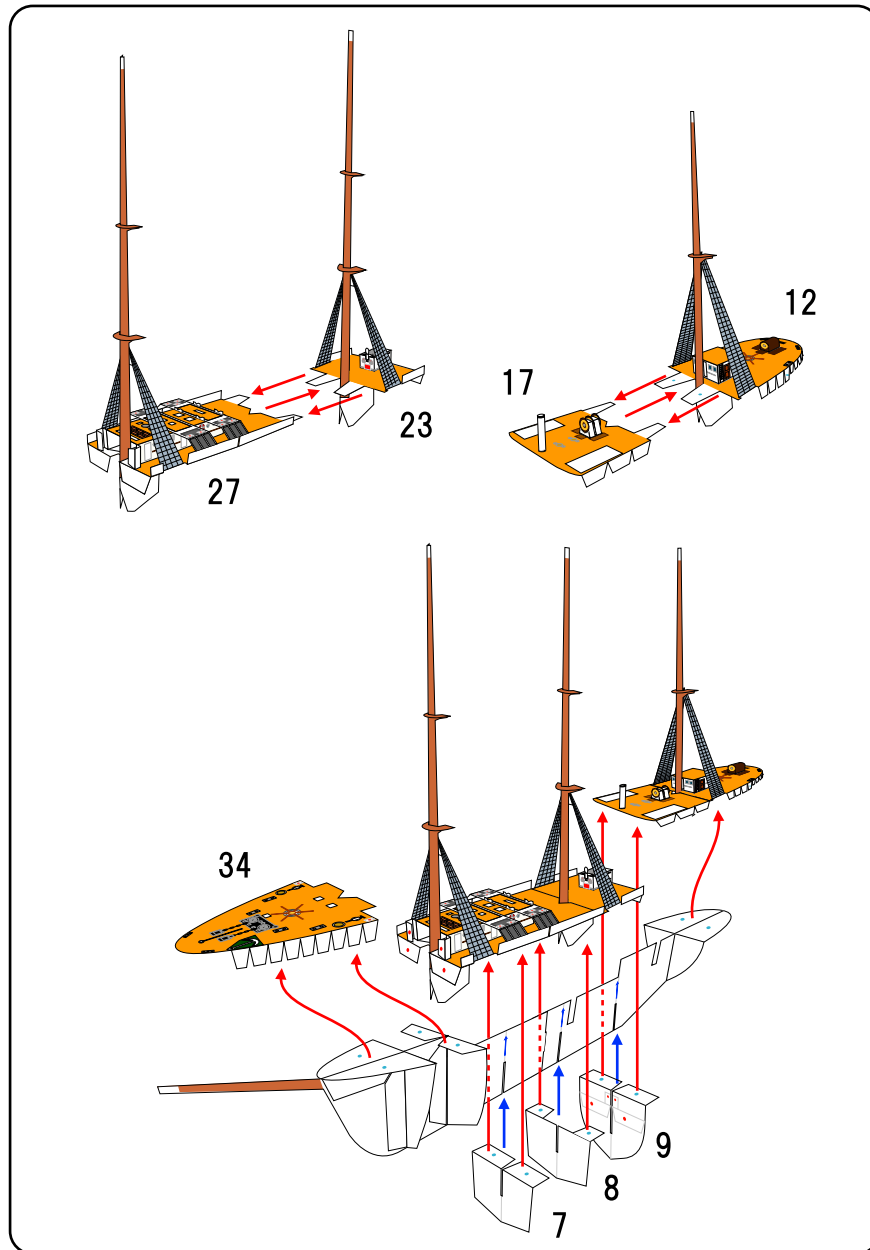

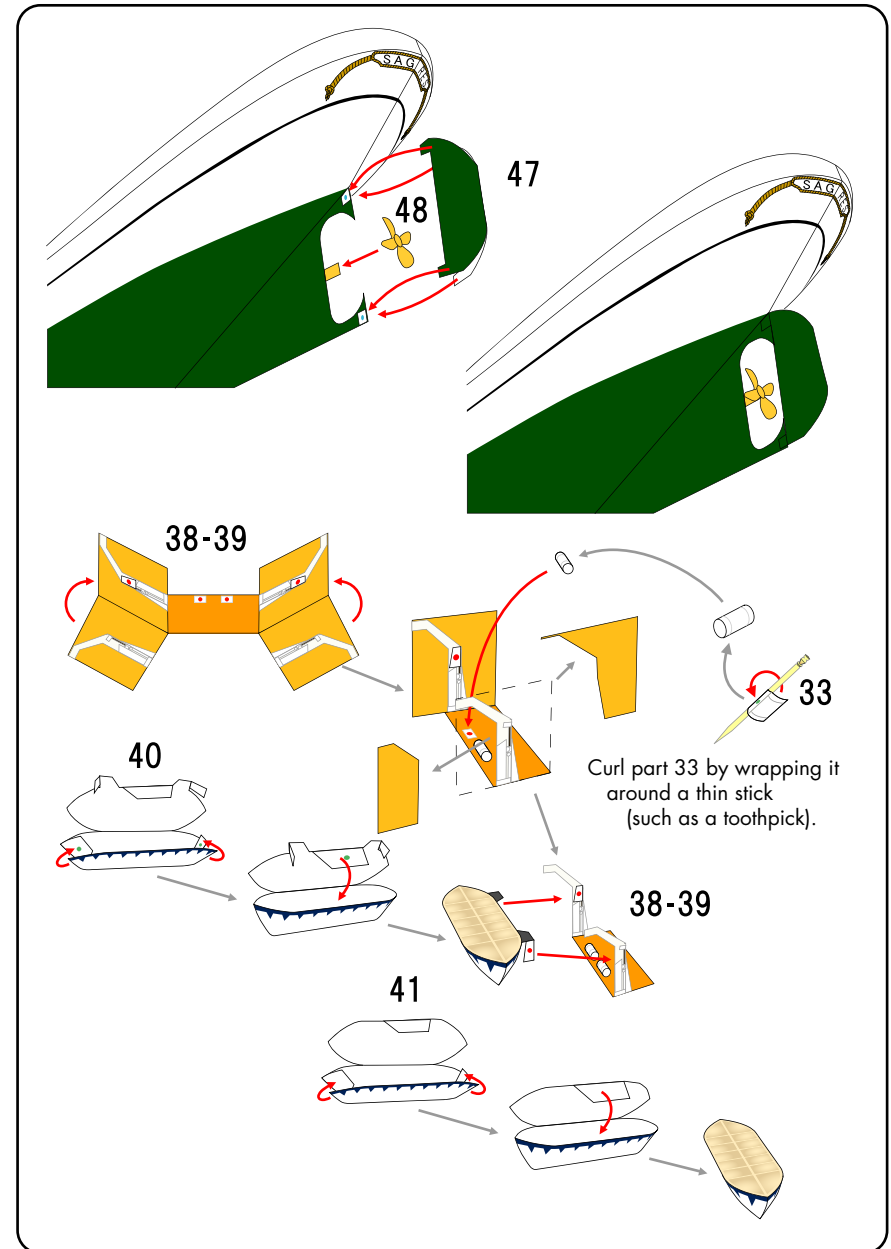
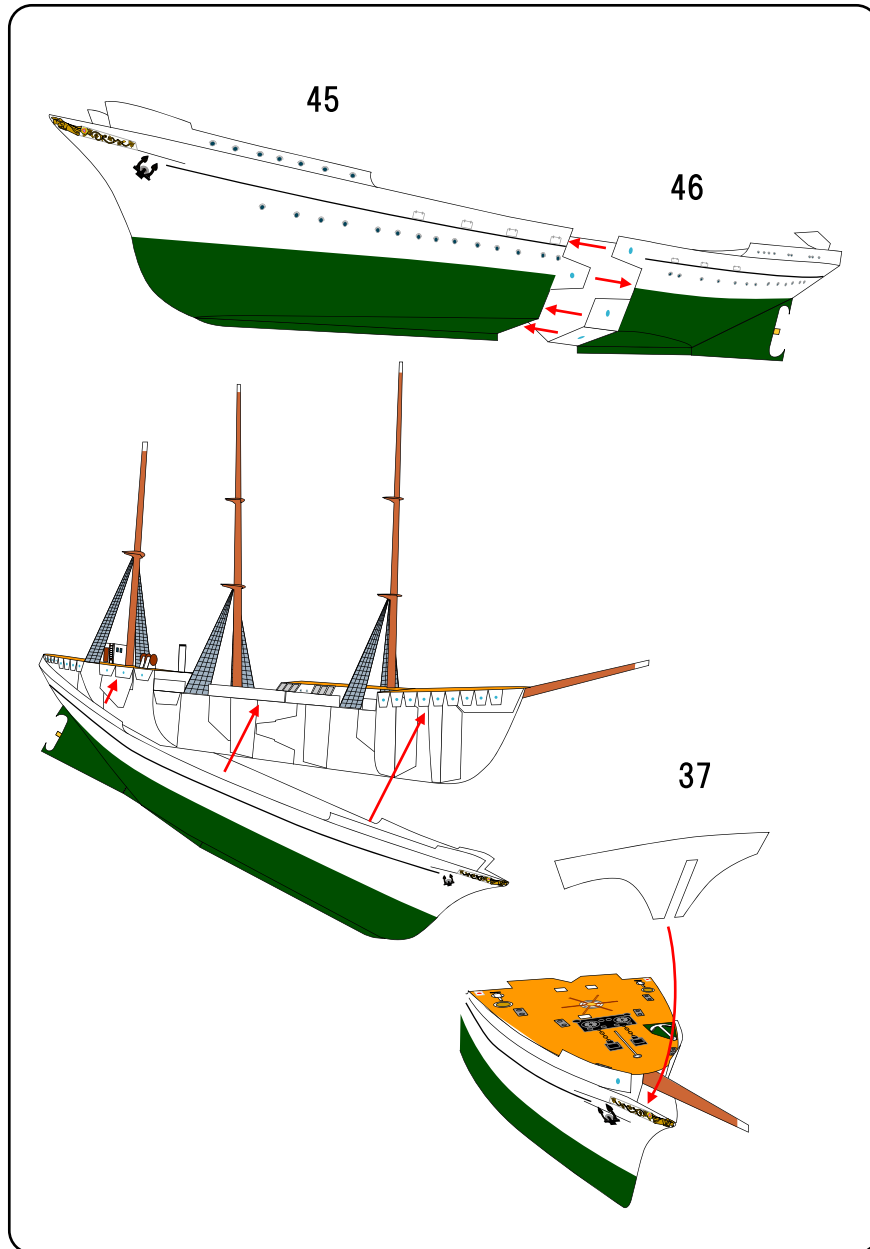

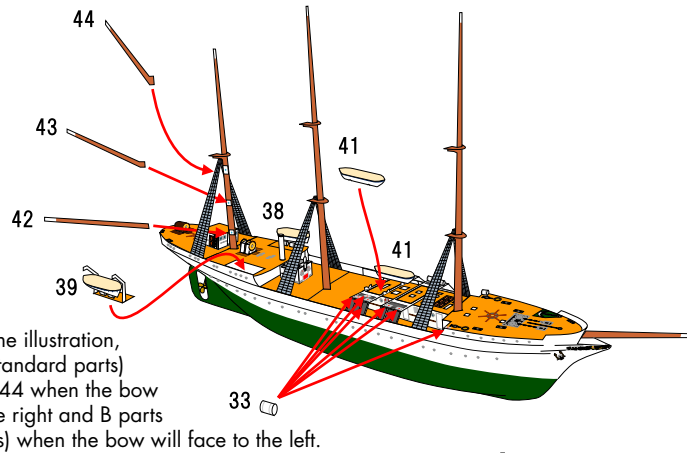

As shown in the illustration, use A parts (standard parts) for parts 42 - 44 when the bow will face to the right and B parts (optional parts) when the bow will face to the left.

Parts 49-58

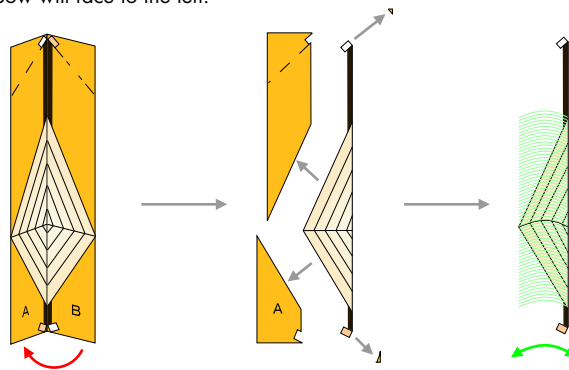

70

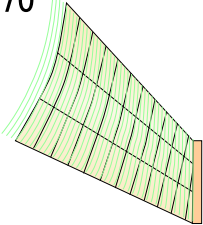

71

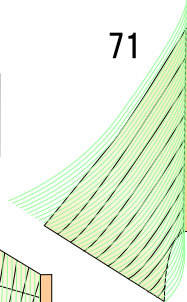

69

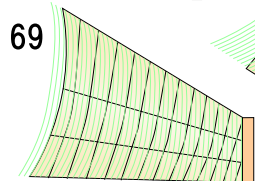

Fold once and glue the folds together, then give the sails a bulging appearance. If you plan to have the bow face to the right, curl the sails so that surface A will bulge out. If the bow will face to the left, curl the sails so that surface B will bulge out.

For parts 69 - 71, choose A parts (standard parts) or B parts (optional parts) depending on the direction in which the bow will point.

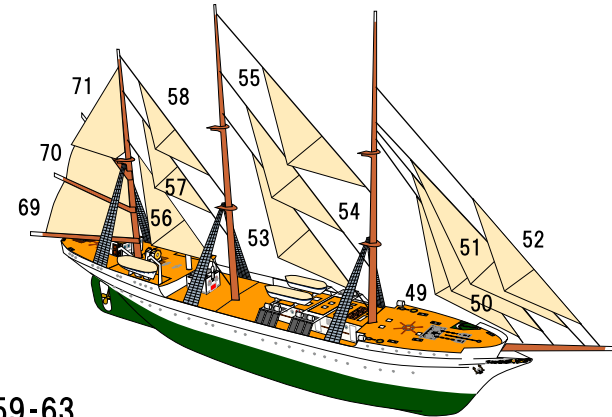

Parts 59-63

Attach parts 59 - 63 (the yards) to the vessel masts. If the bow will point to the right, attach the yards so that surface A is on top. If the bow will face to the left, attach so that surface B is on top. Glue the yards in place at an angle, as shown in the illustration, so that the model will resemble a ship sailing in the wind.

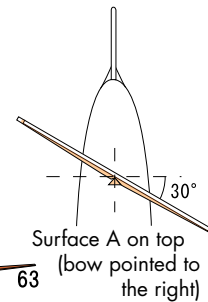
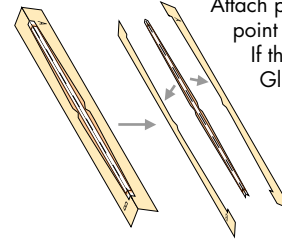

Surface A on top (bow pointed to the right)

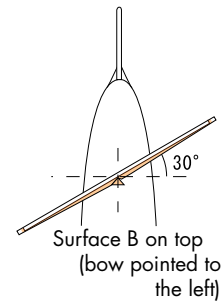

Surface B on top (bow pointed to the left)

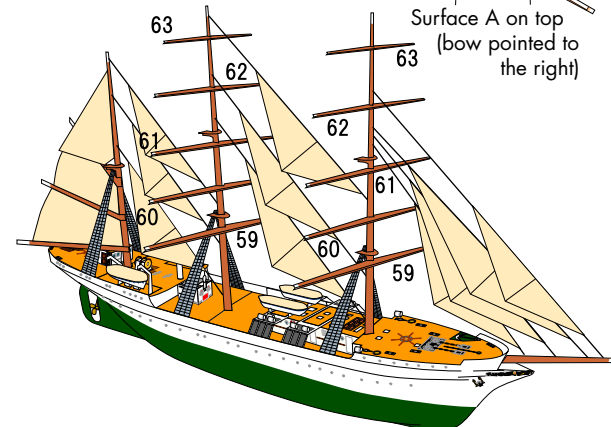



After folding parts 64 - 68 (the square sails) in two and gluing them, cut out the yellow guides. After curling these from top to bottom as shown in the illustration, make them curl from the center to the outside, to make it appear as if they are catching the wind.

Parts 64-68

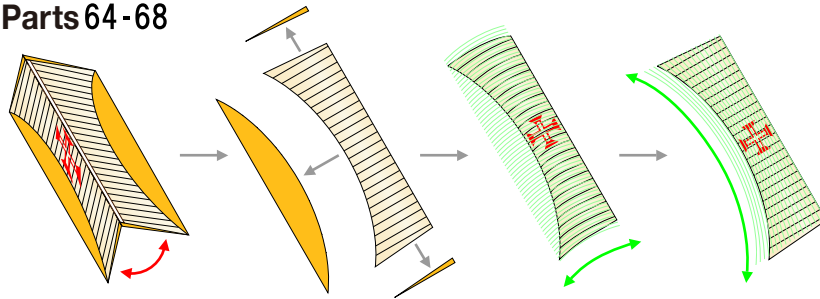

Glue the rear sides of these parts together.

