

Soccer Penalty Kick Game



Cut out the parts, and then carefully follow the assembly instructions.

Tools & Materials

- Scissors, utility knife
- Glue stick and wood glue
- Ruler or set square
- Pencil
- Object with pointed tip (dried-up ballpoint pen, stencil pen, etc.)
- Toothpicks
- Tweezers

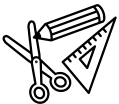

Tips for Assembly

- Keep track of which part is which by writing each part's number in pencil on the back of the part.
- Use a dried-up ballpoint pen, stencil pen, or other pointed object and a ruler to score along the fold lines. This will create sharper, neater folds.
- Before gluing, fold and crease along the fold lines and add curves where needed.
- Use a toothpick when applying glue. Thinly applied glue gives a neater finish.
- Use tweezers when picking up and attaching small parts.

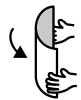

Caution

- This paper craft uses scissors, utility knives, glue, and other items and materials which may be dangerous to children. Keep these items and materials out of reach of children while you work.
- Take care not to injure yourself when using scissors, utility knives, and other sharp or pointed objects.



Symbols and Notation



Pattern



Assembly instructions

(1), (2), (3)...

Part numbers



Mountain fold line (dotted line)



Valley fold line (dotted & dashed line)



Cut line (solid line)



Partial cut line (solid red line)



Cut-out area



Apply glue (red arrow)



Insert (blue arrow) (Do not apply glue)



Add curves



Dots on glue tabs show where and how to glue parts together.



Glue tab (red dot) Glue one part to another part



Glue tab (green dot) Glue one place to another on the same part



Glue tab (blue dot) Glue one part to the reverse of another part



Glue tab (yellow dot) Glue the reverse of two parts together

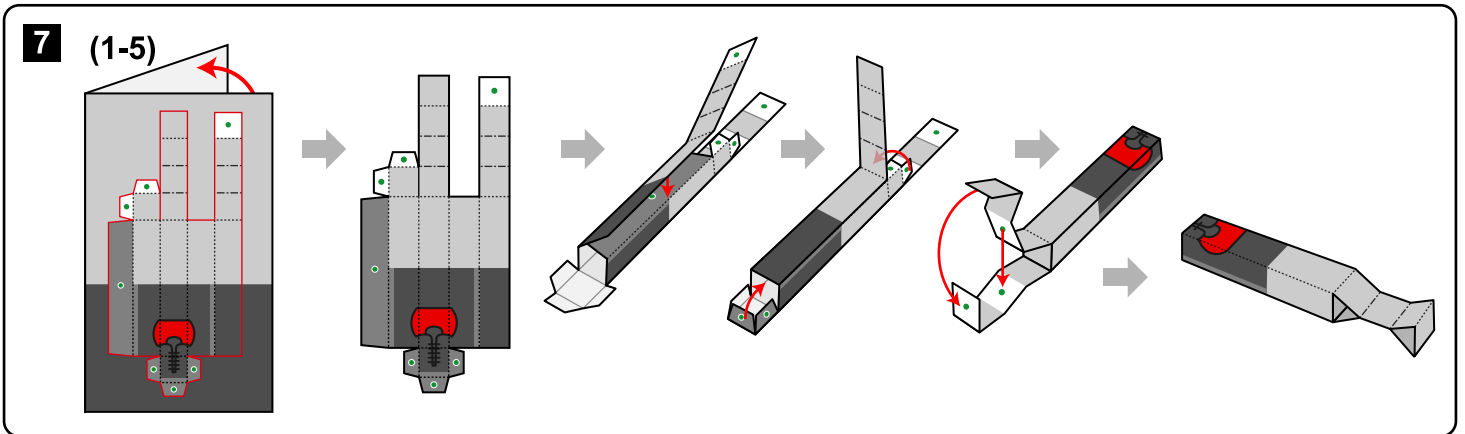
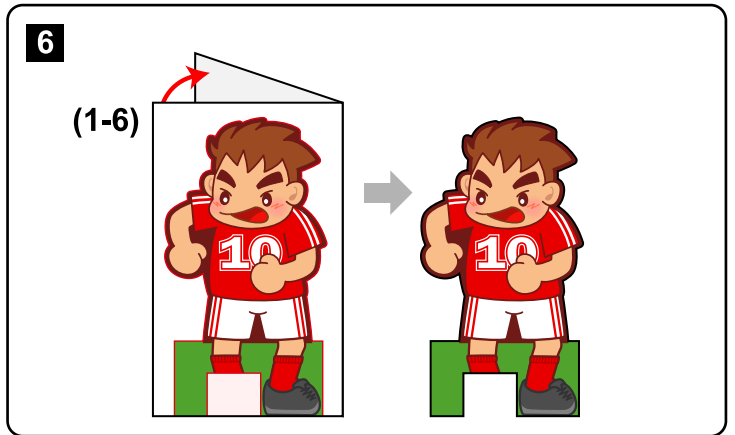
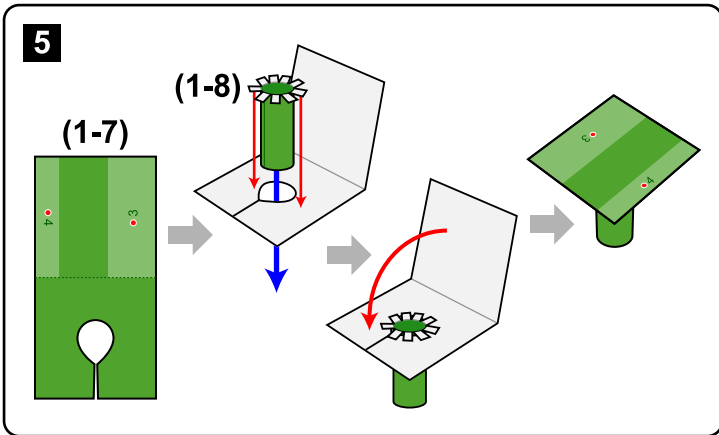
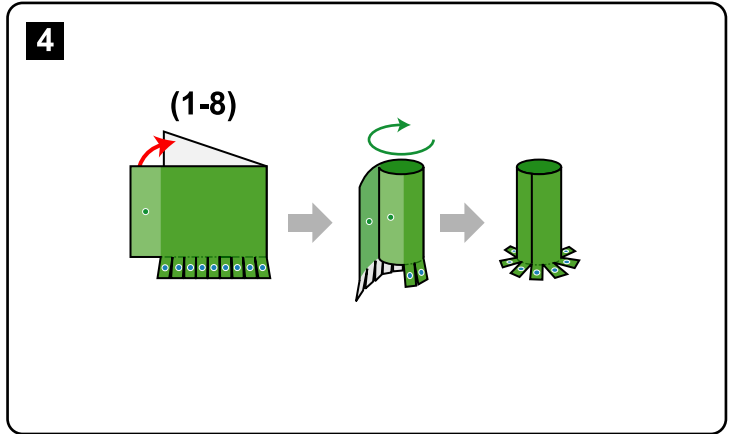
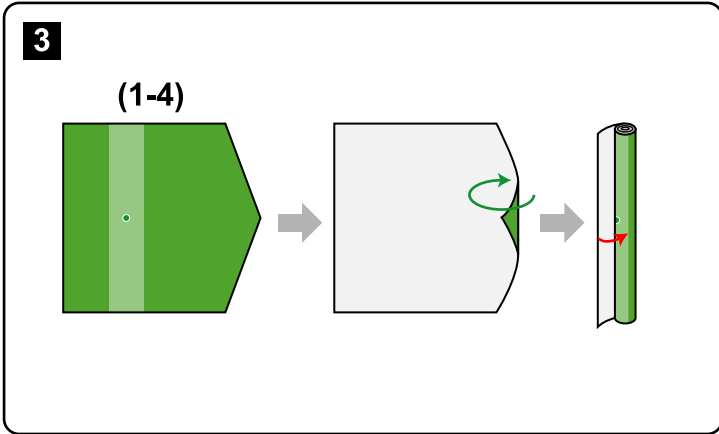
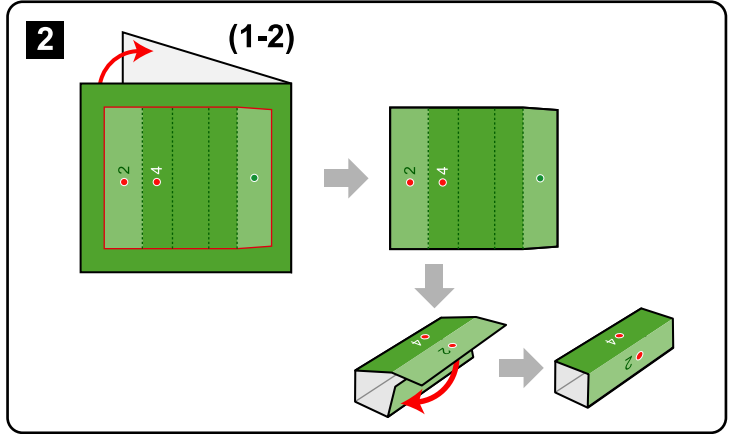
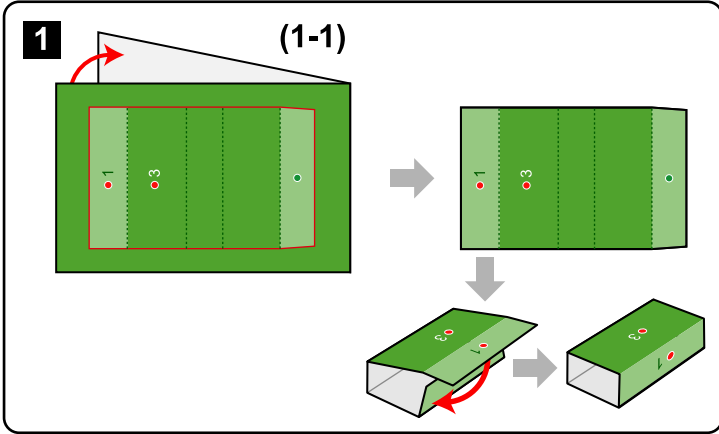

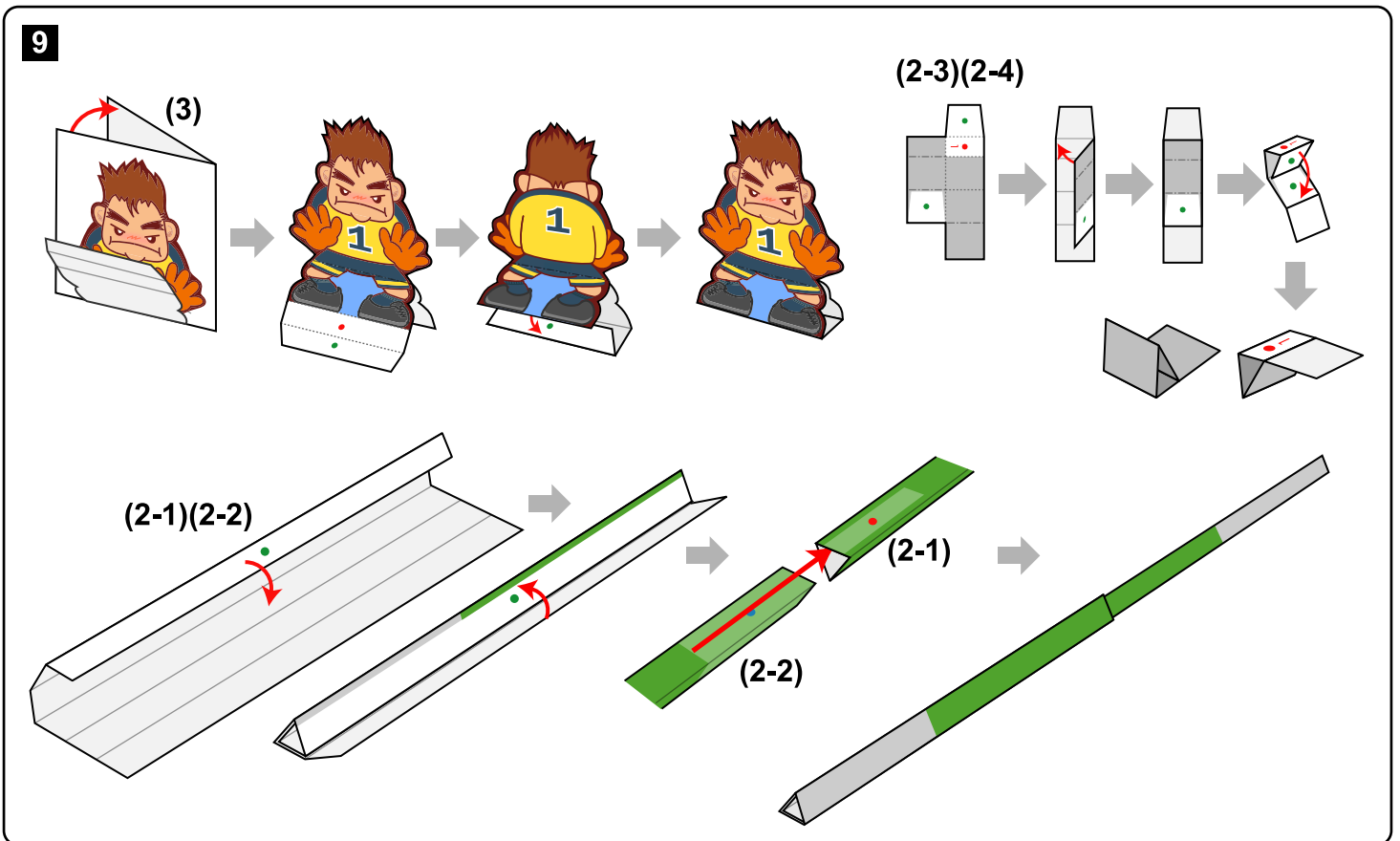
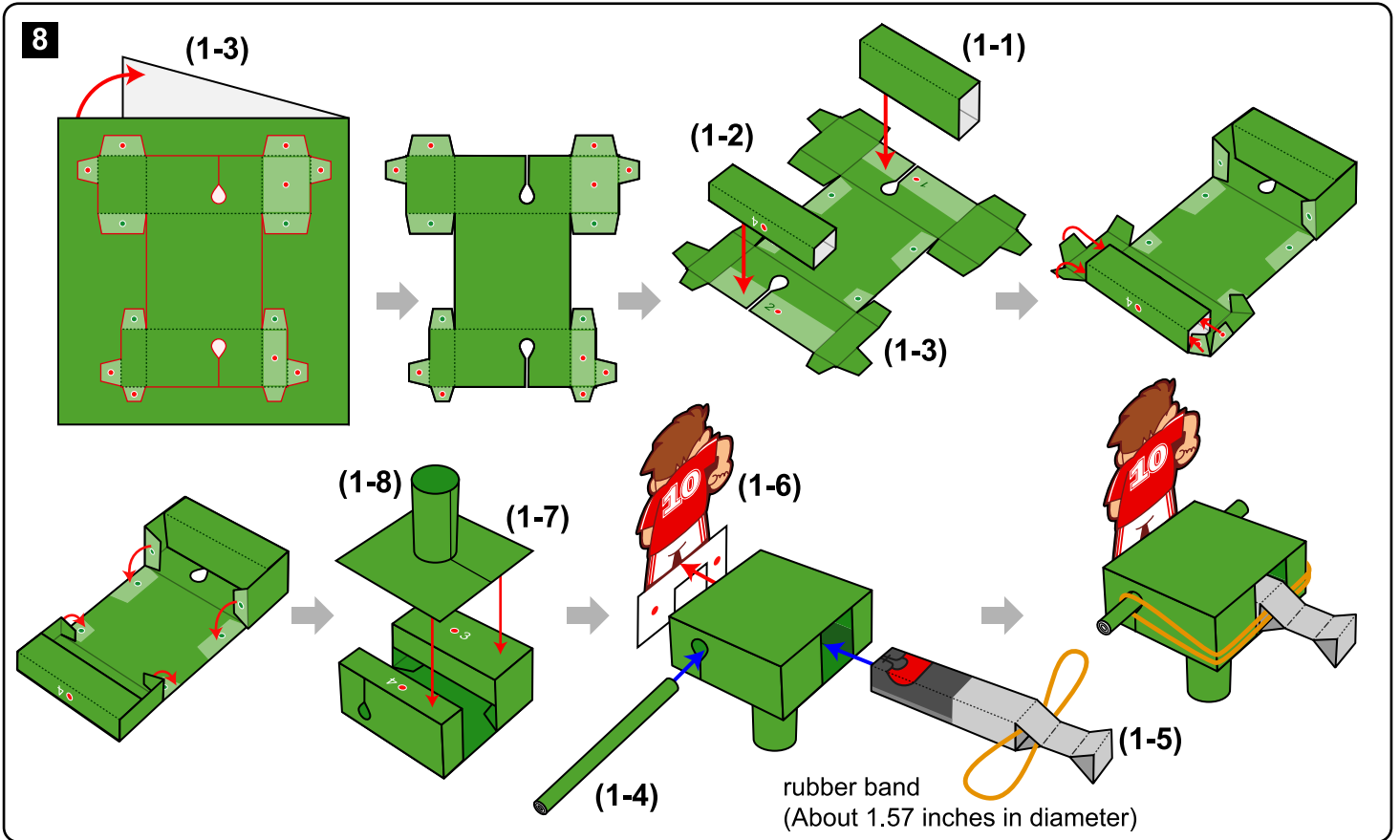

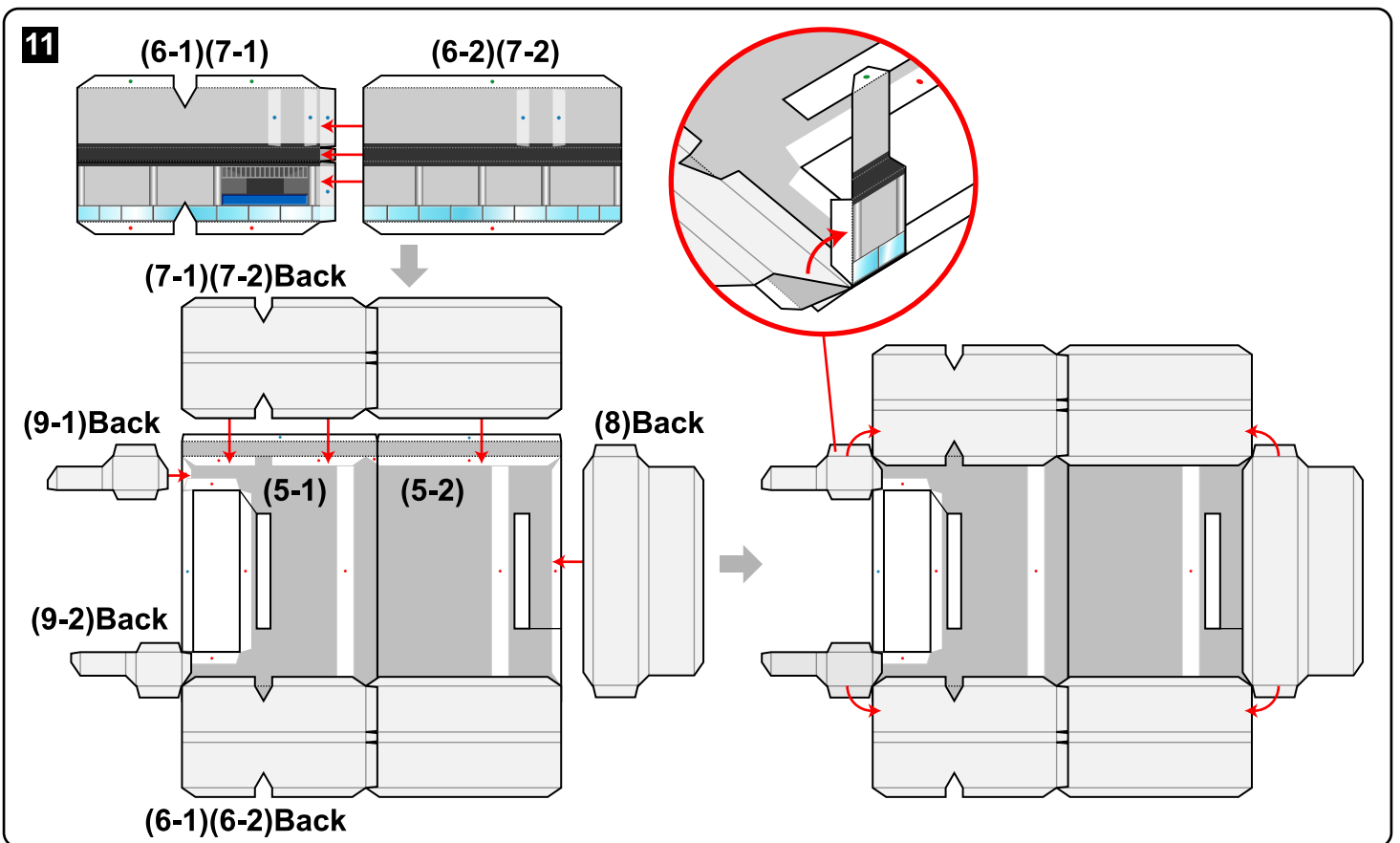
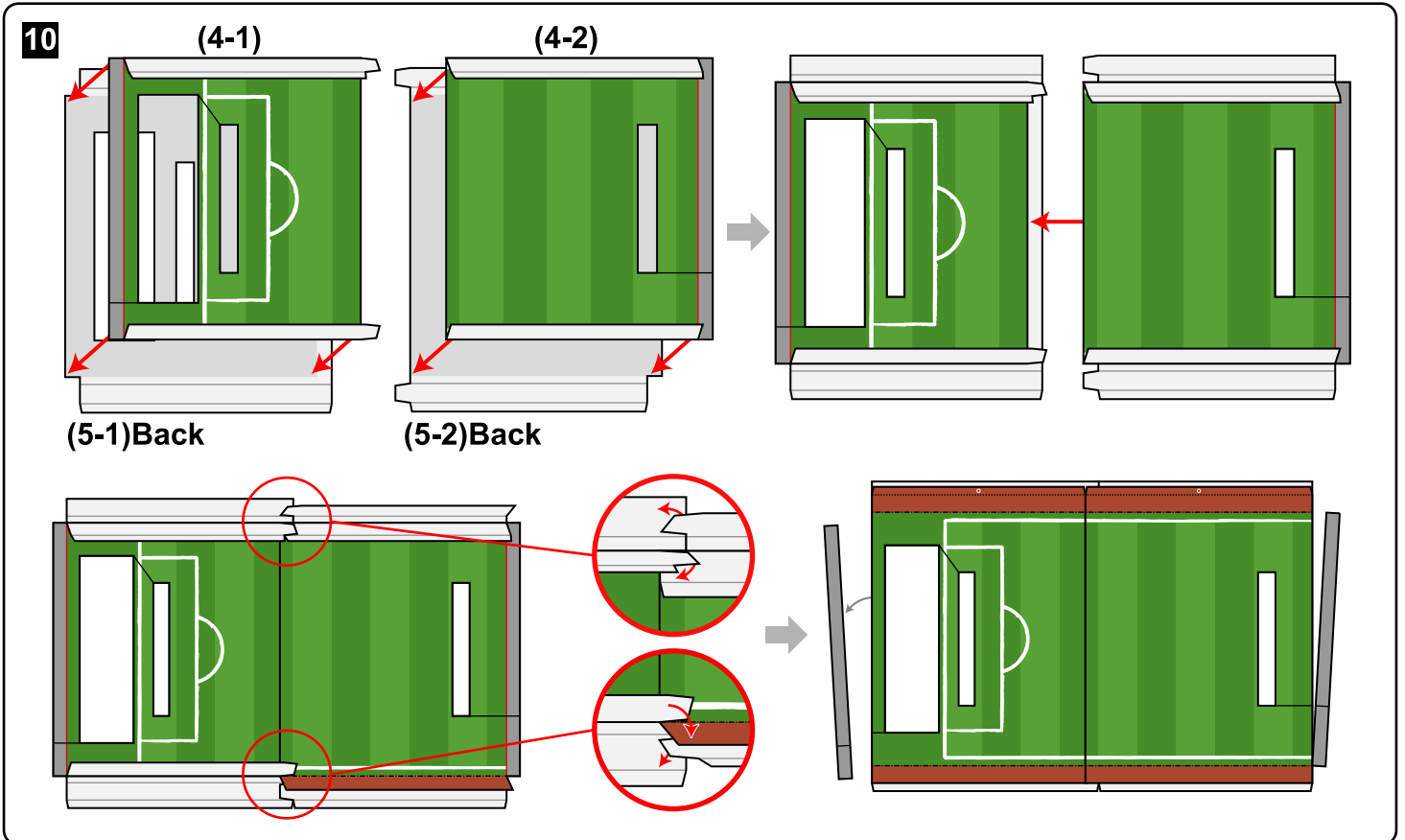

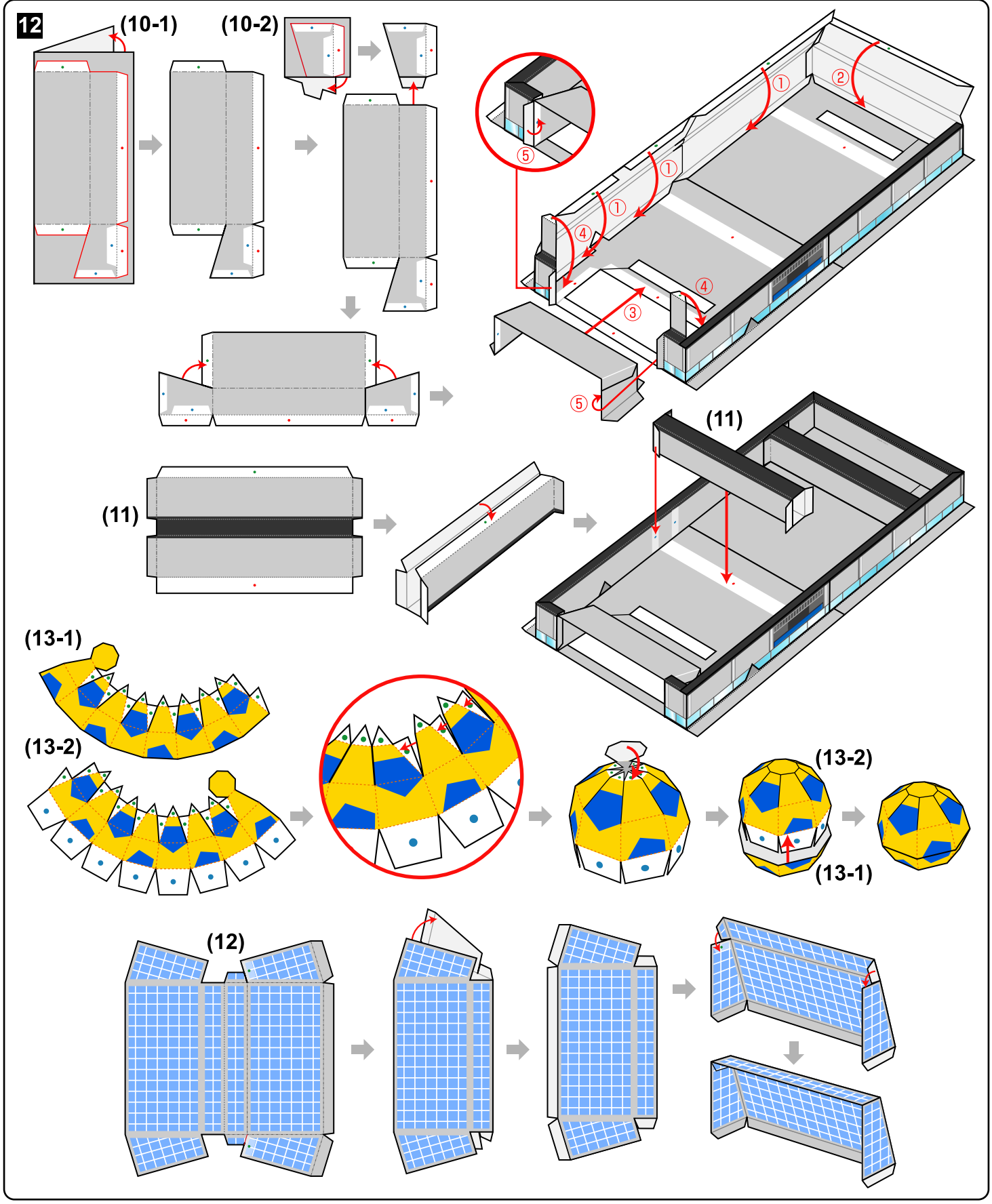



13

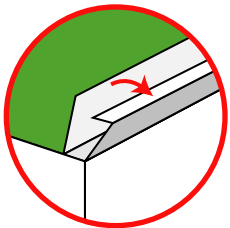
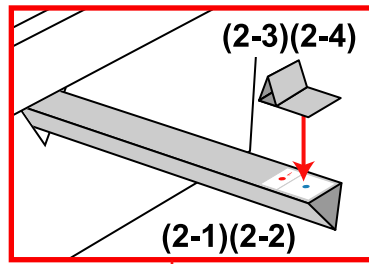
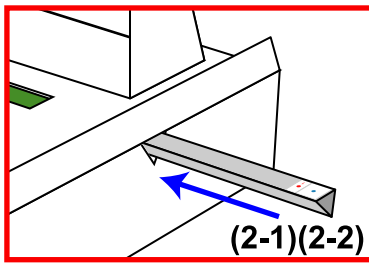

(12)

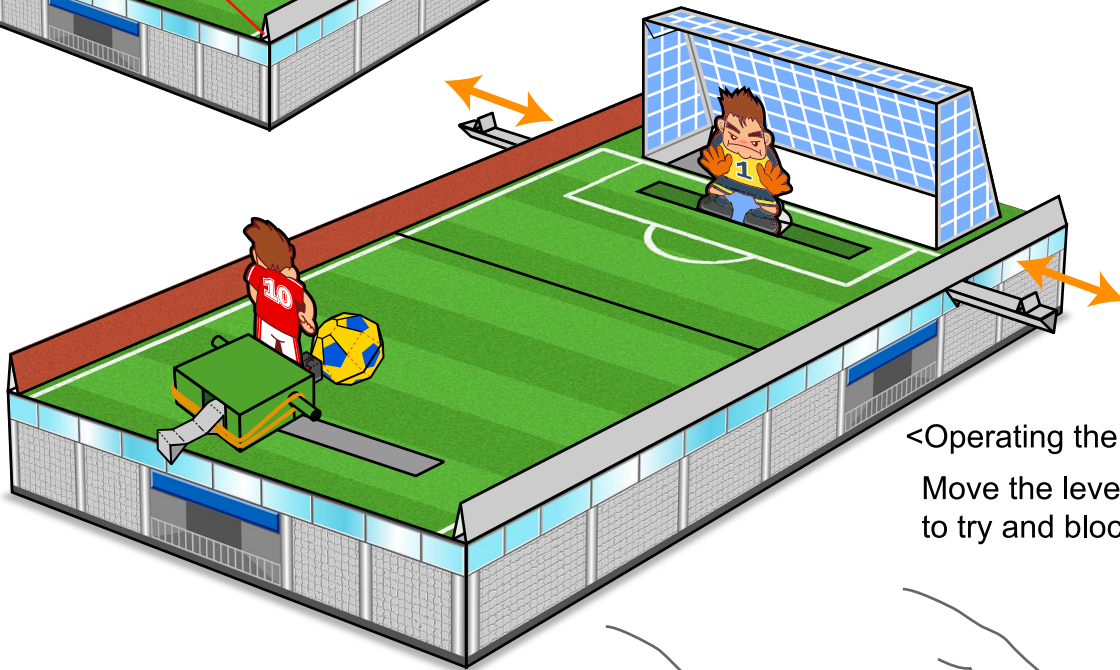
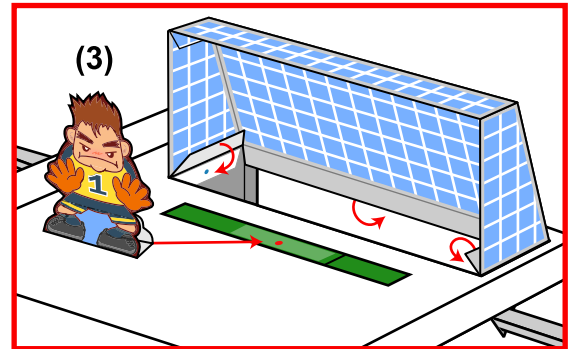
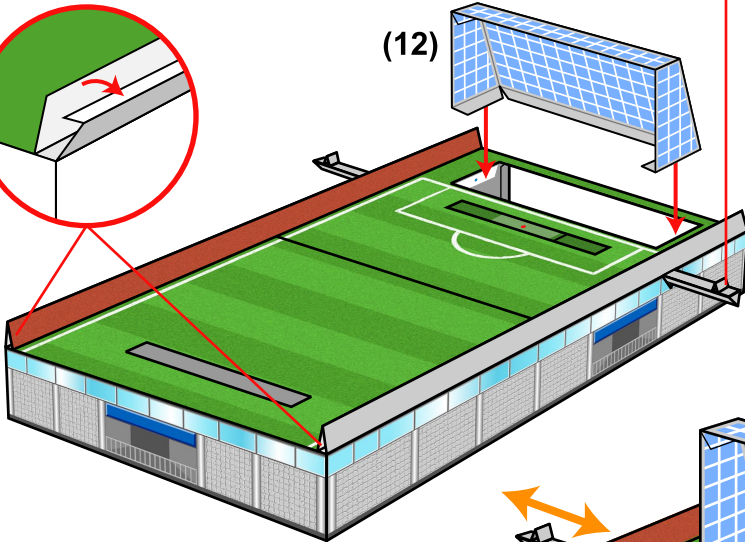

<Operating the keeper>
Move the lever left or right to try and block the ball.

<Operating the kicker>
Move the kicker to the position you want to kick from, and put the ball next to his feet. Next, pull the lever back and move the kicker so his kicking foot is behind the ball. Then, let go of the lever.

