

**A** Front Cowl

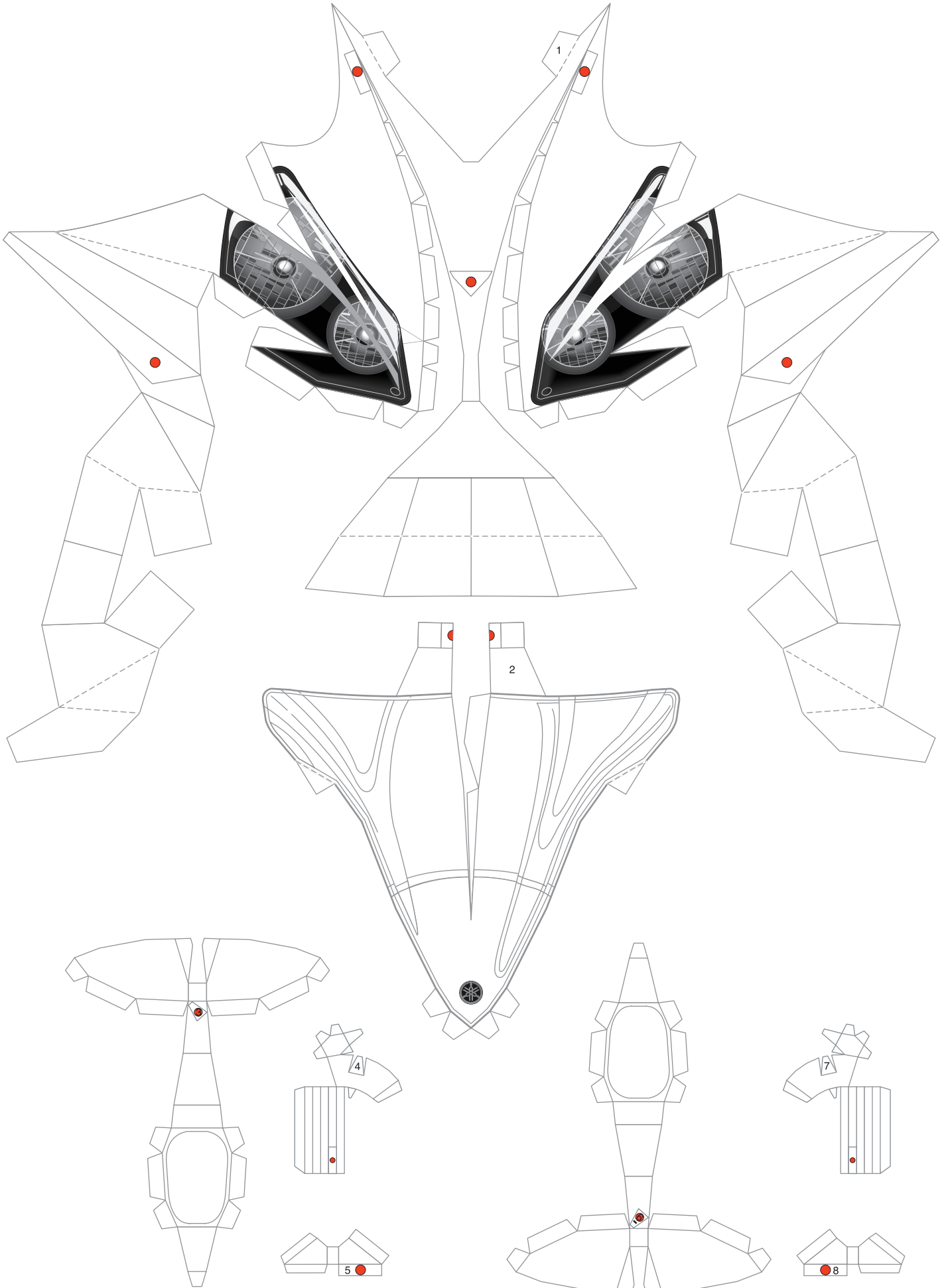

**B** Front Fender & Meter

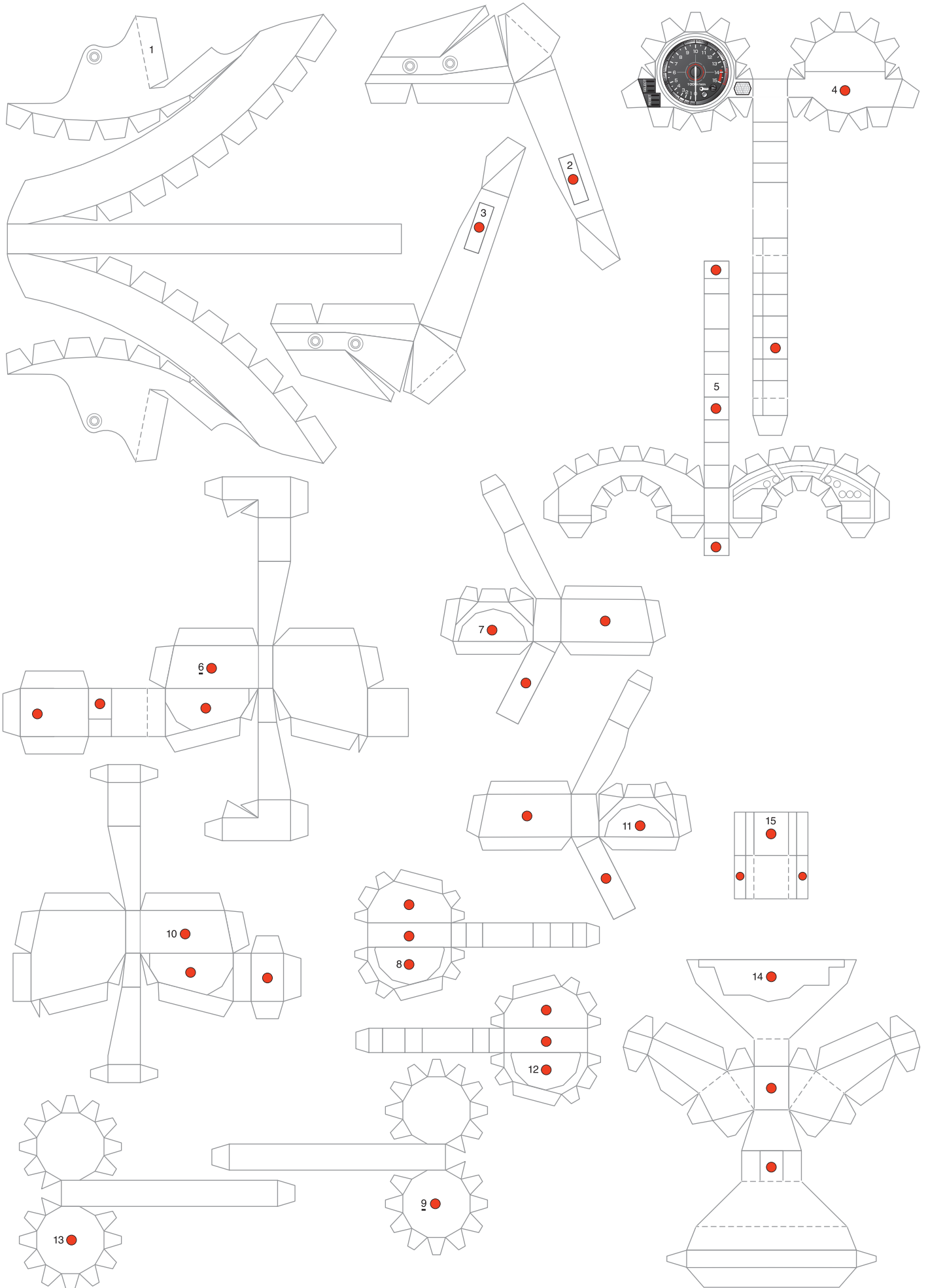

**B** Brake Caliper & Steering

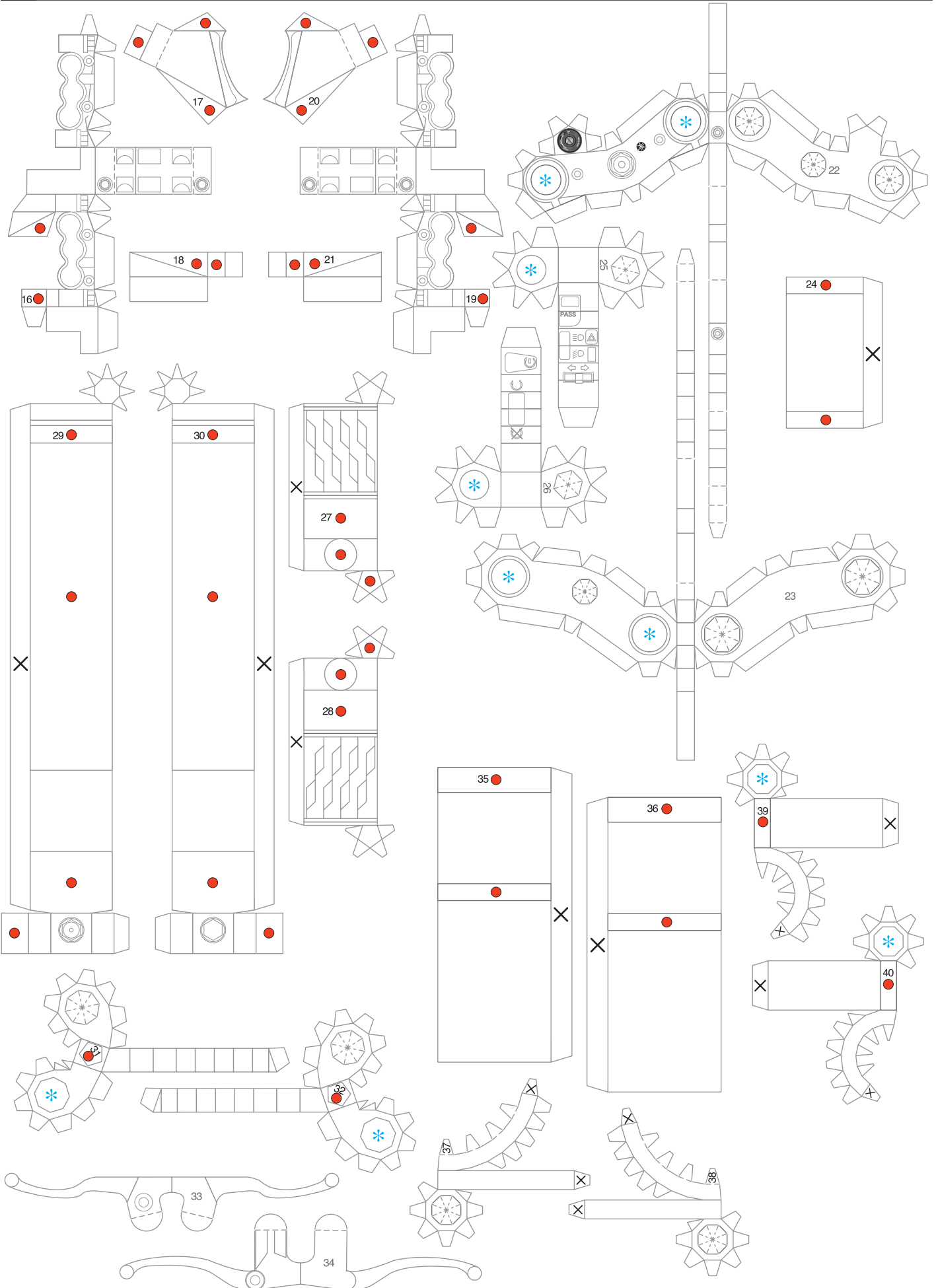

**C** Frame1

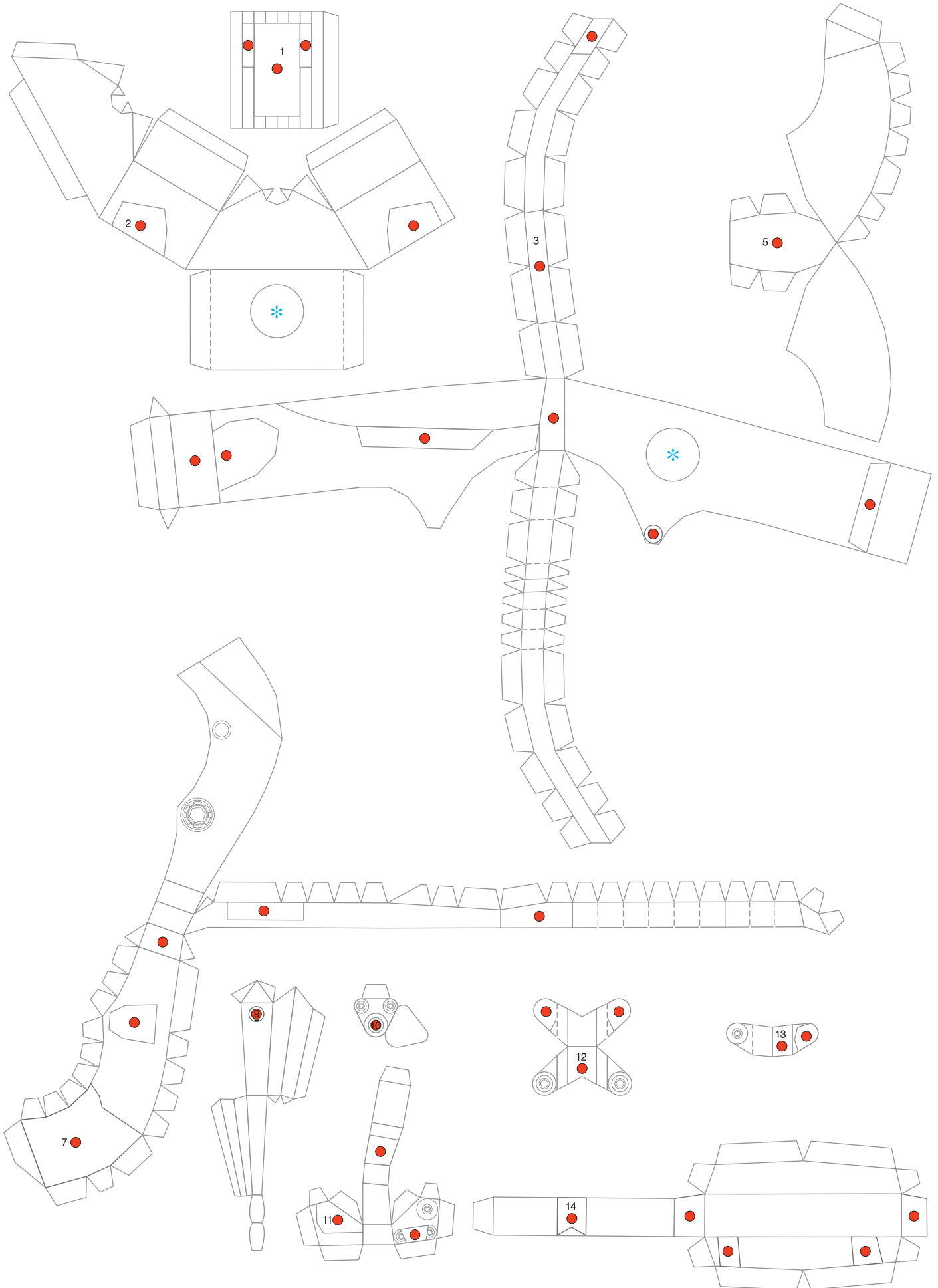

**C** Frame1

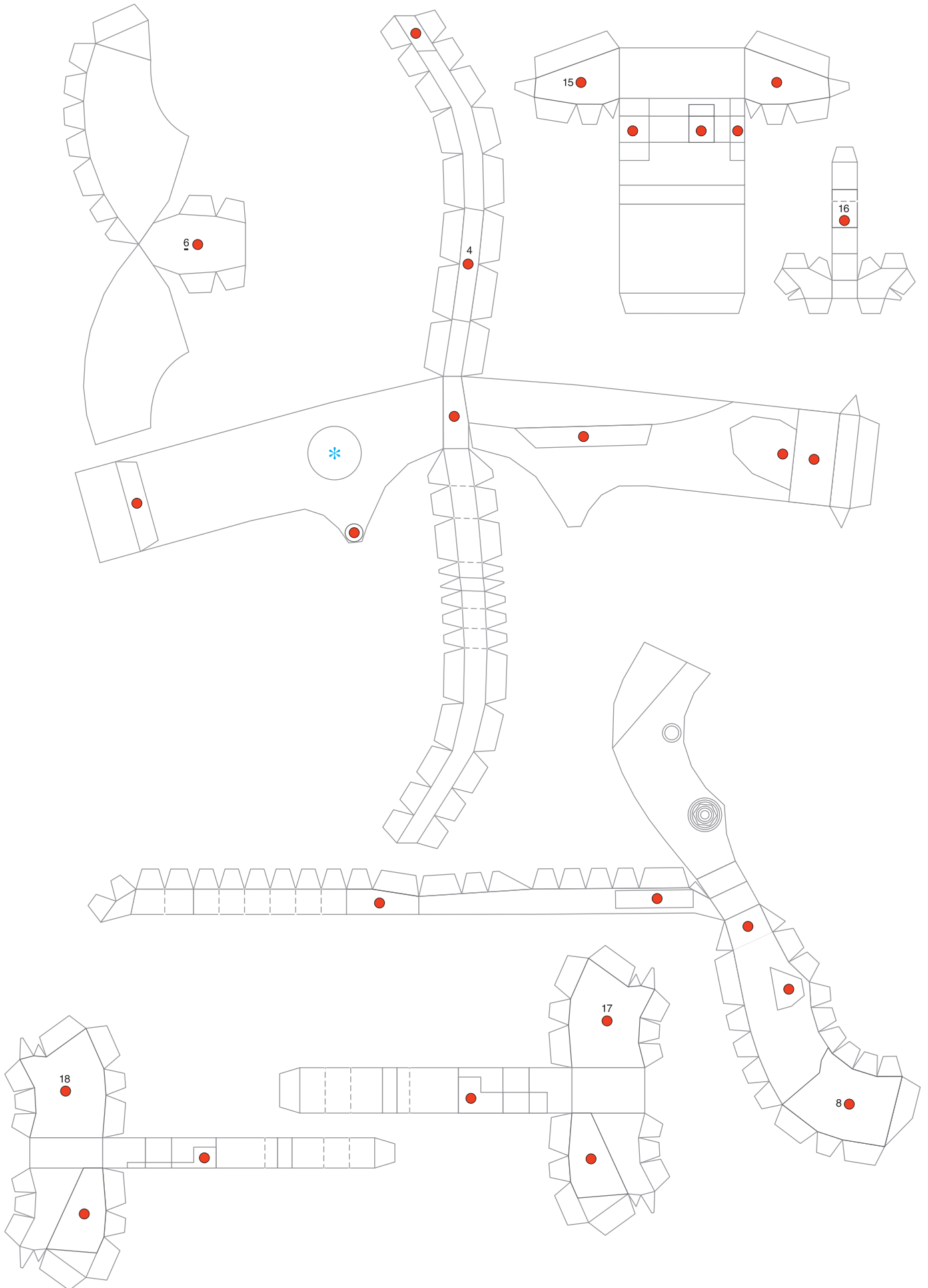

**C** Frame 2

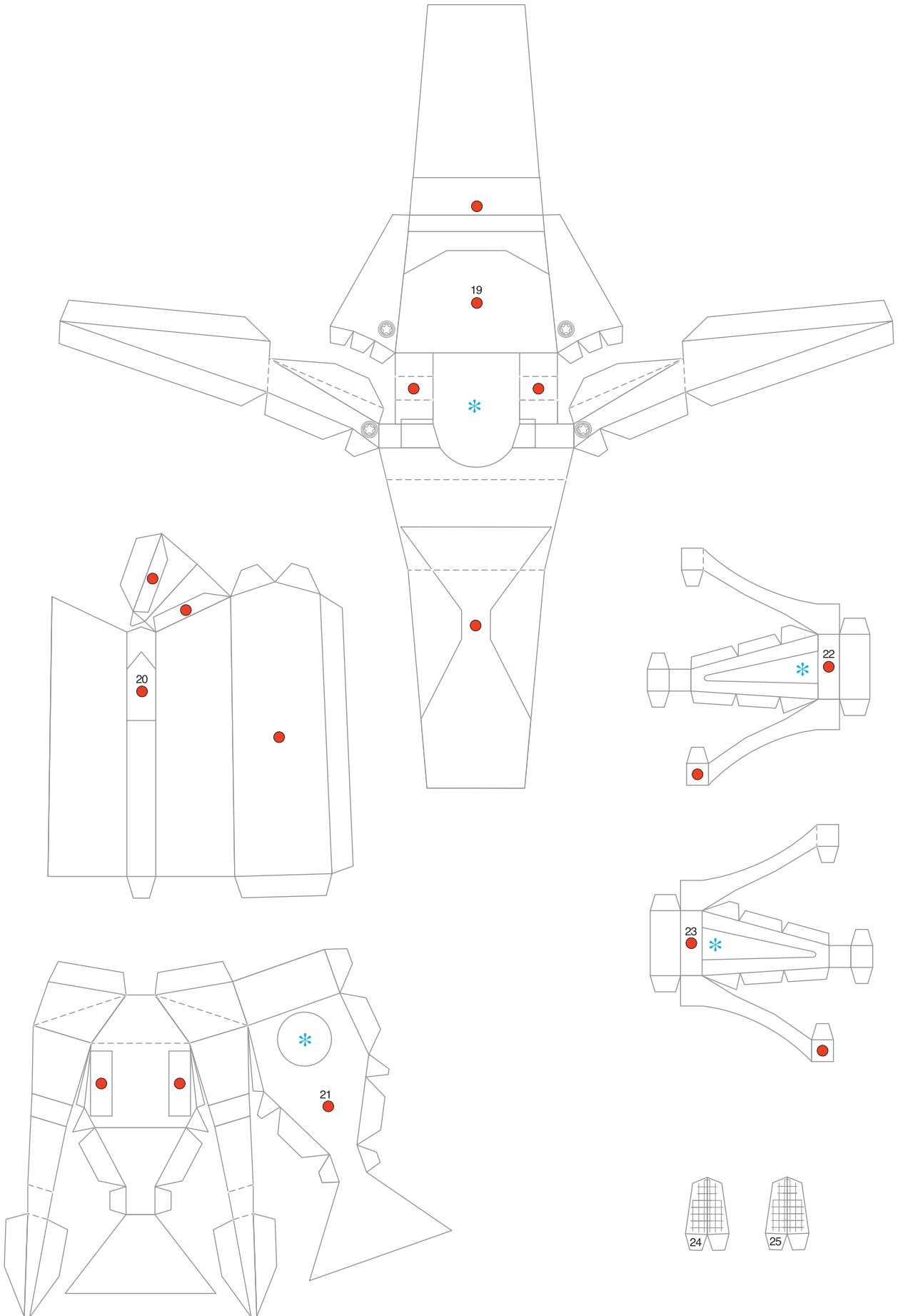

**D** Fuel Tank

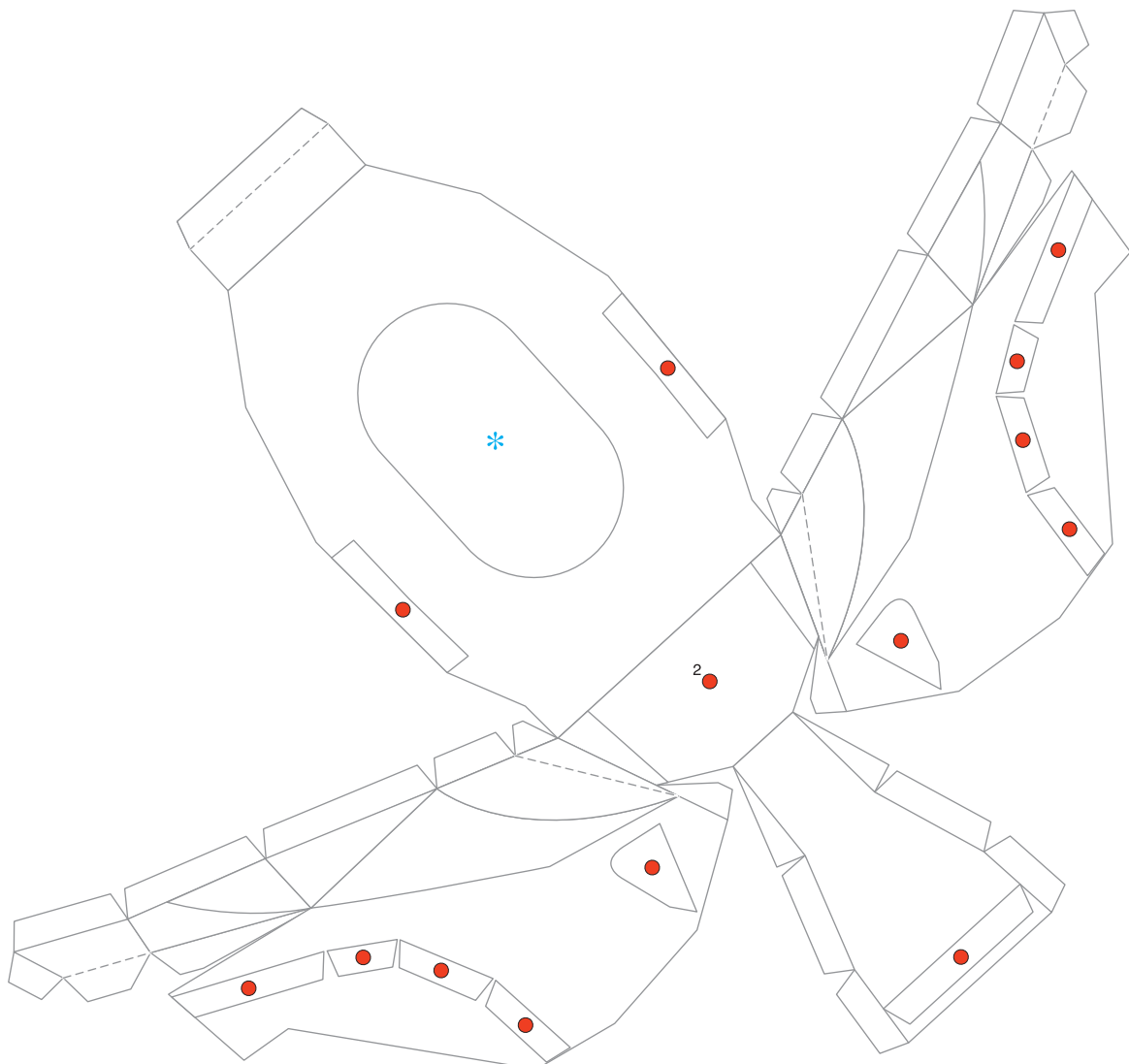
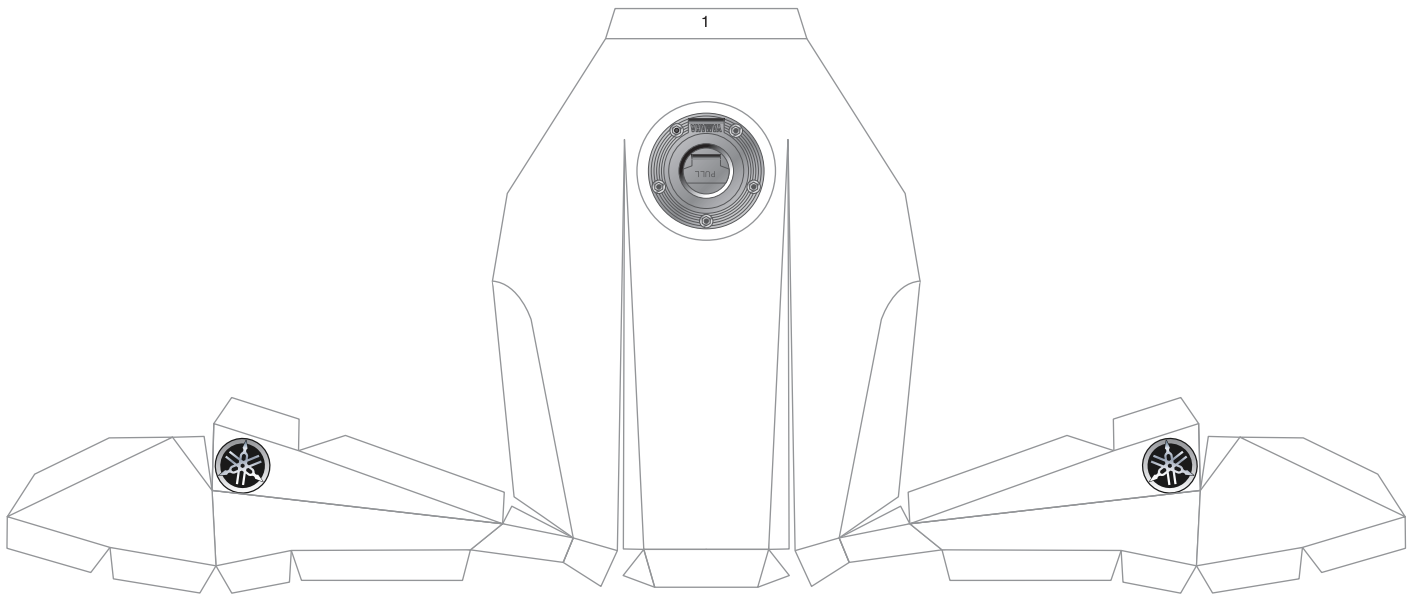

**E** Under Cowl

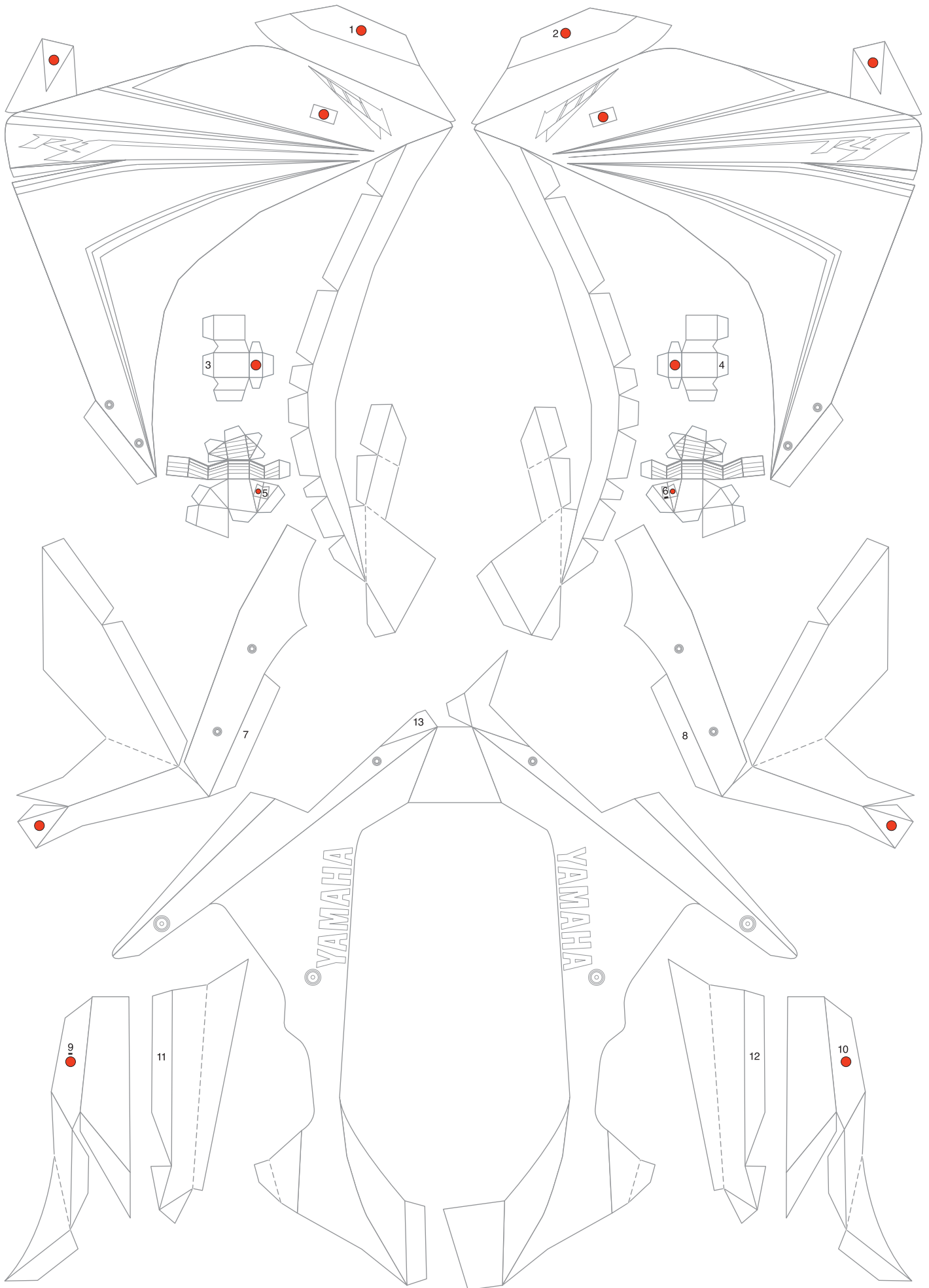



**F** Seat Cowl

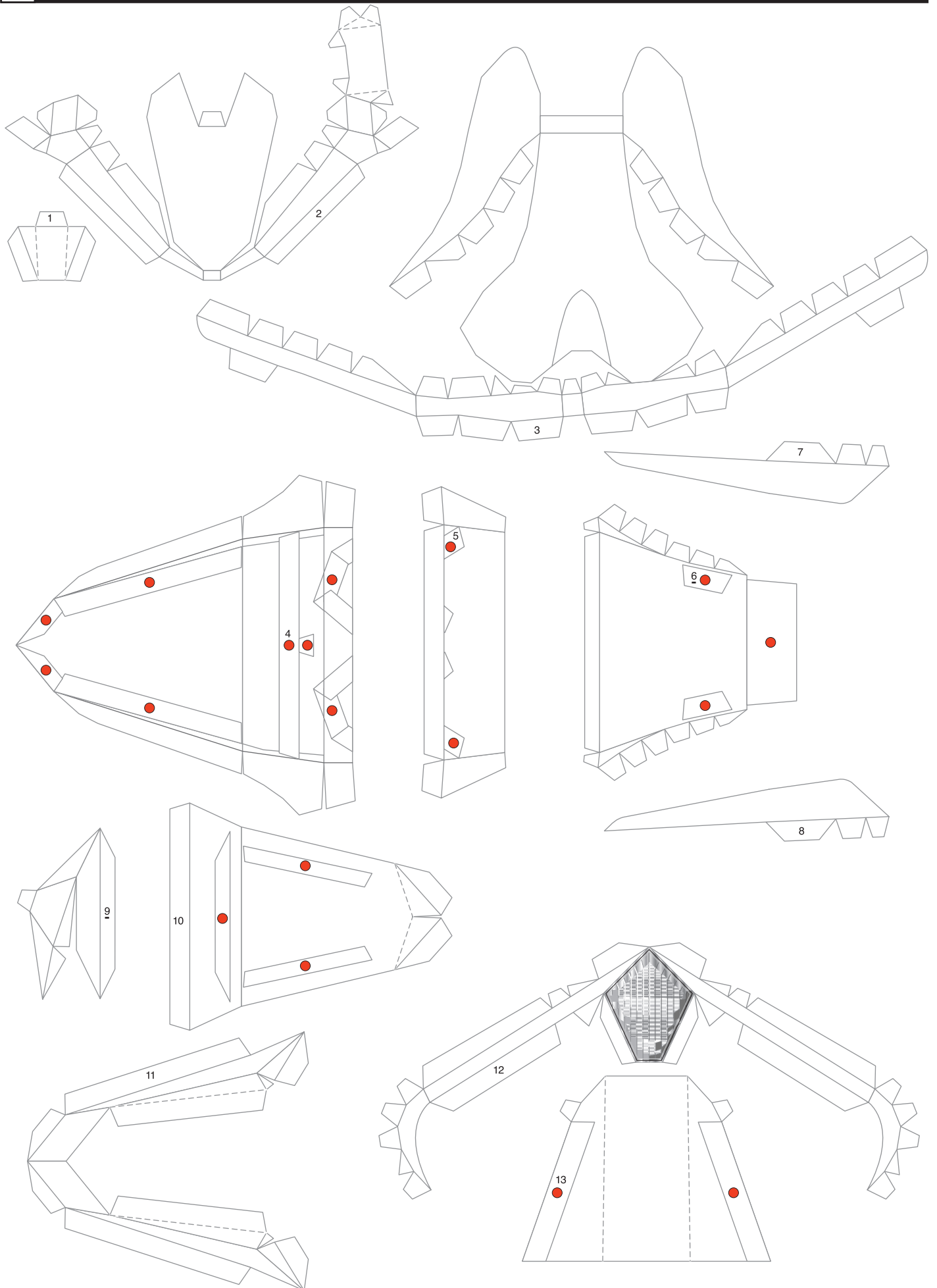

**G** Taillight

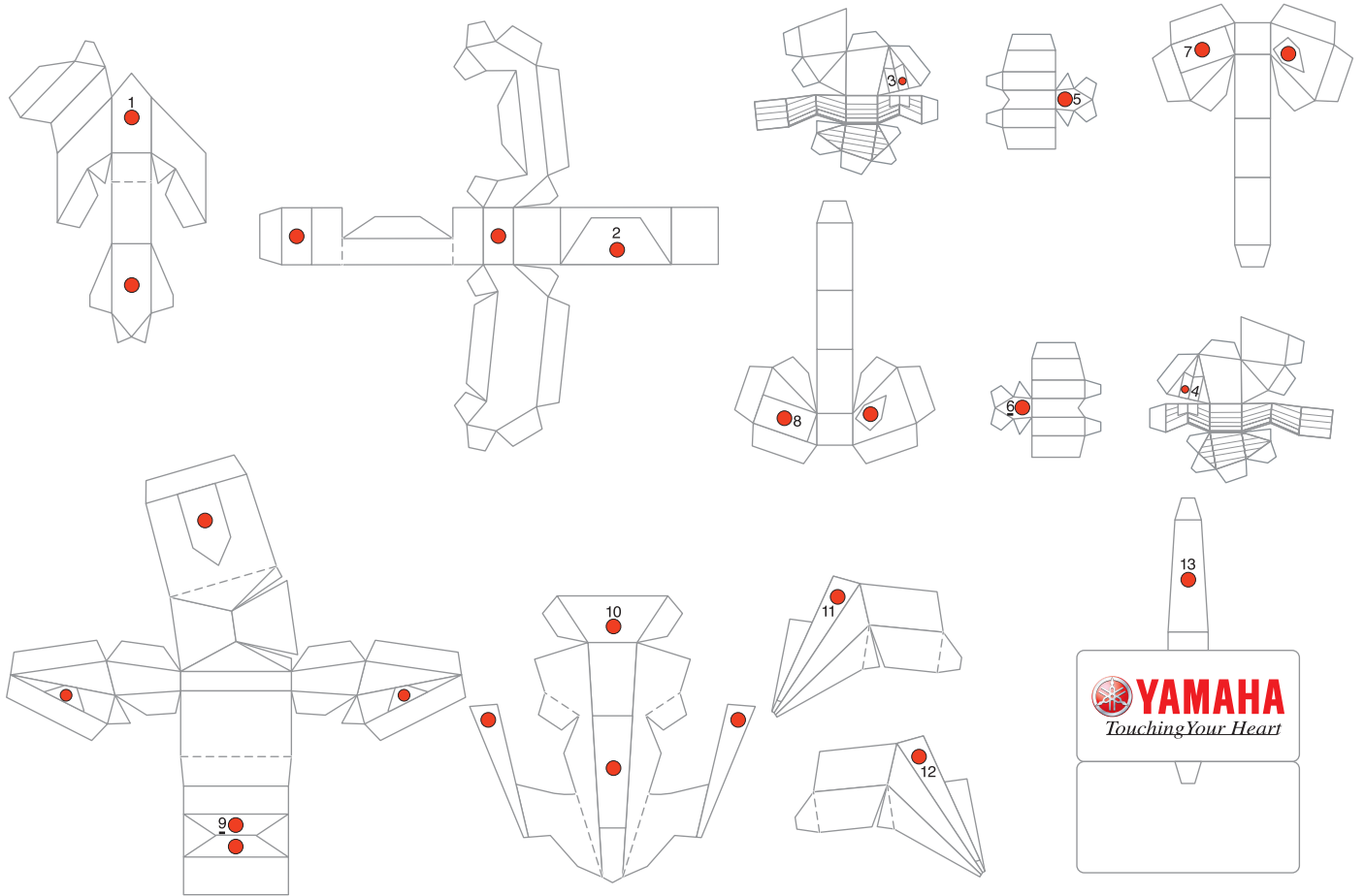

**H** Rear Suspension

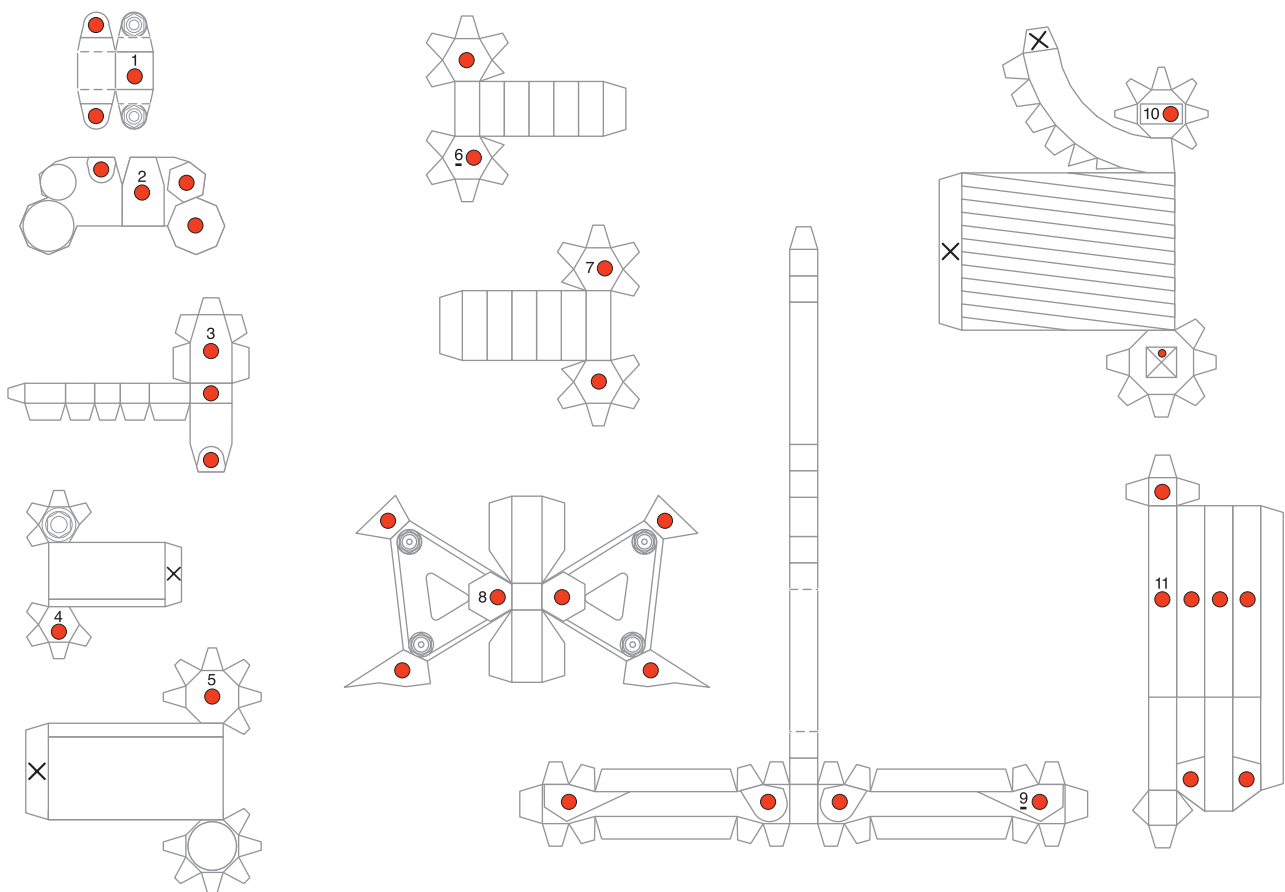

**I** Rear Arm

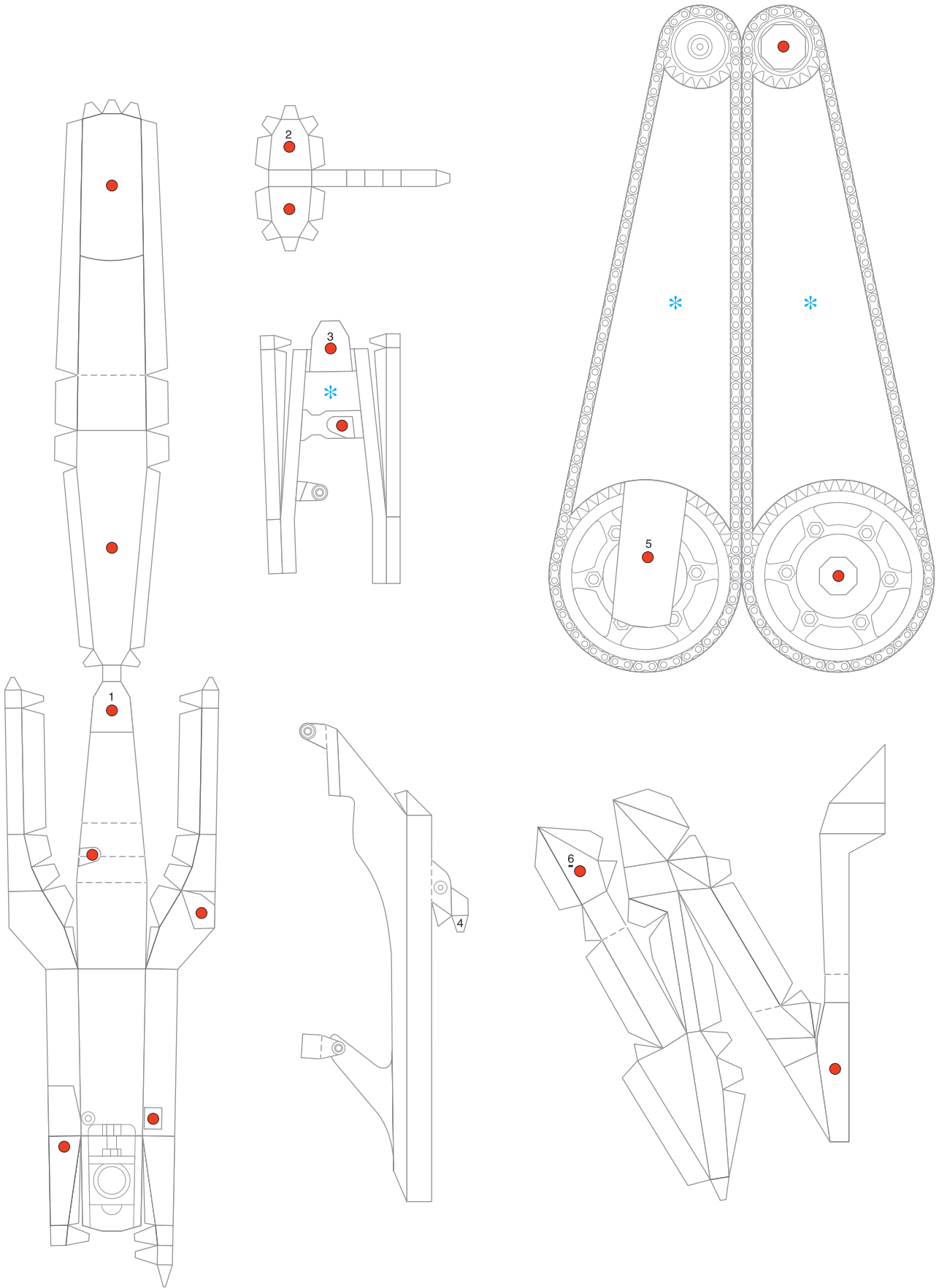

**I** Rear Arm

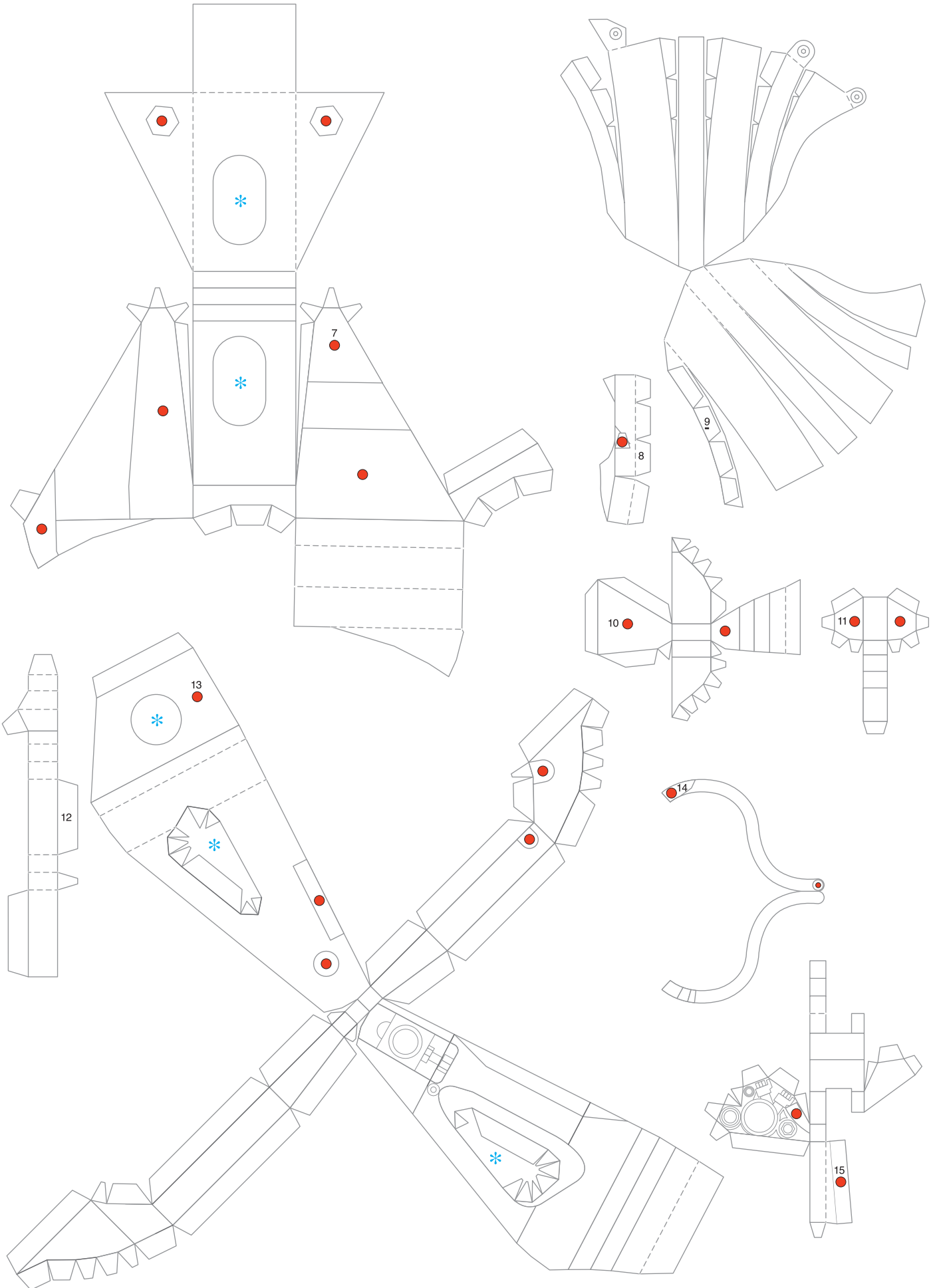

**J** Engine

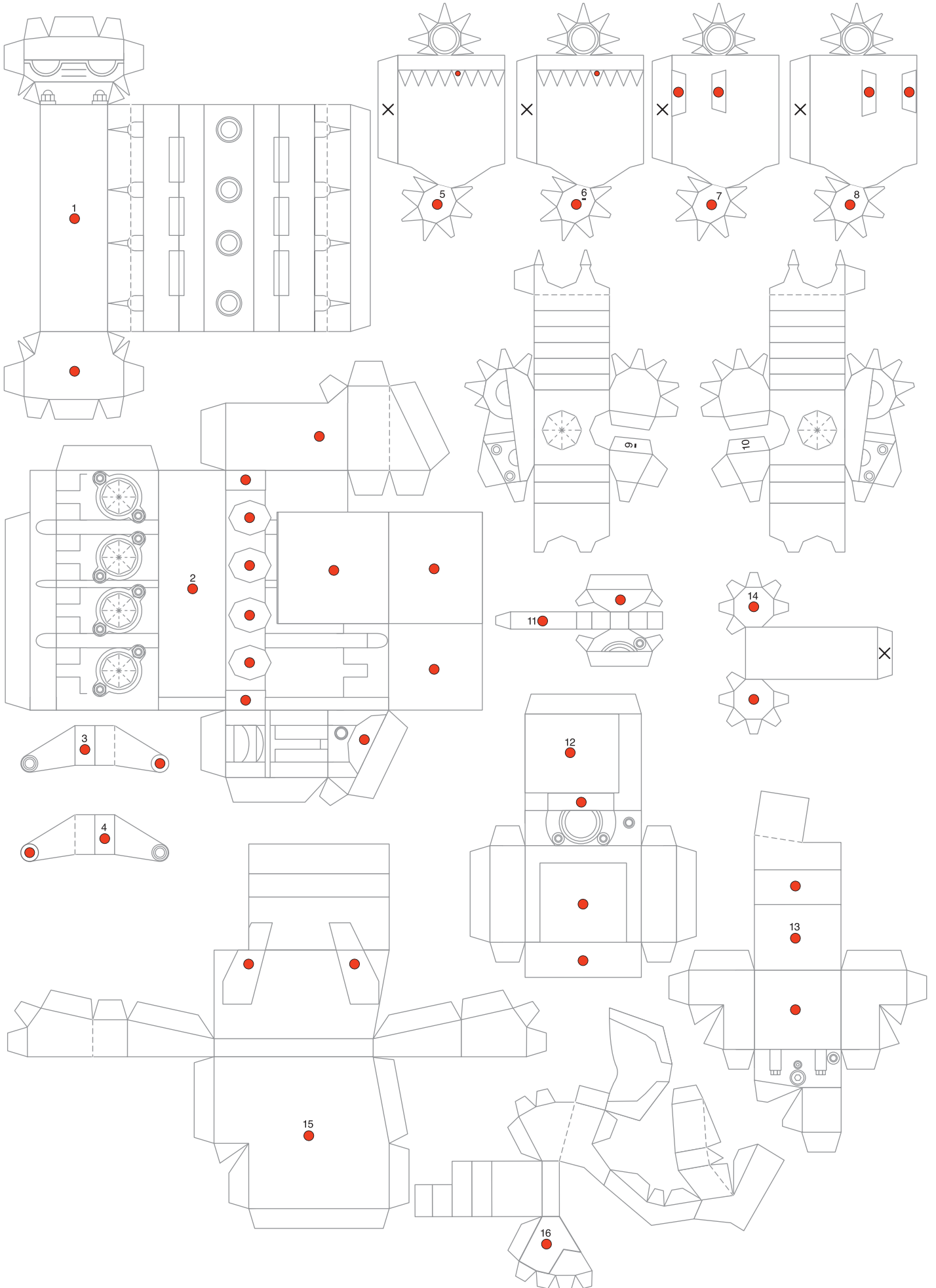

**J** Engine

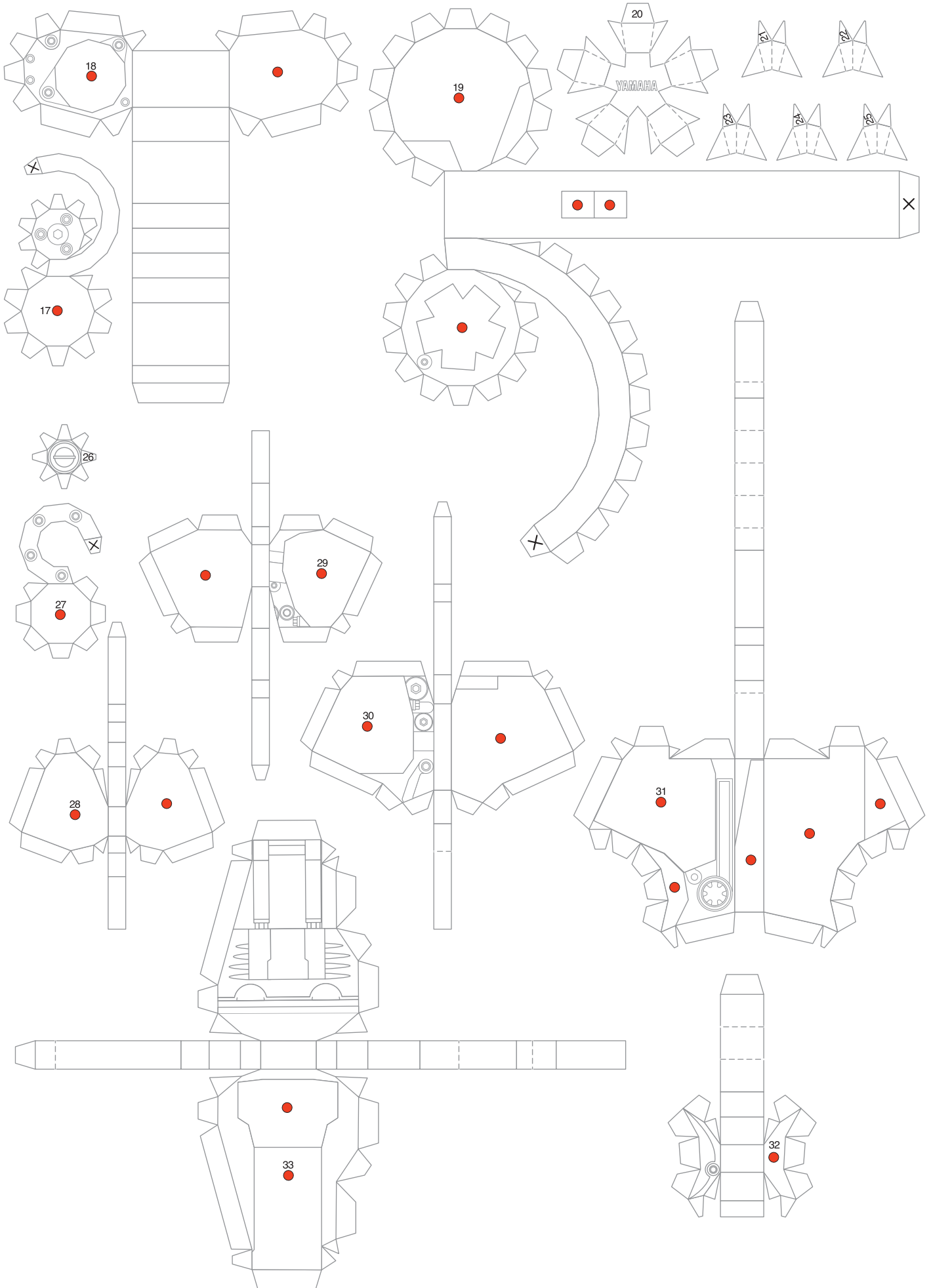

**J** Engine & Radiator

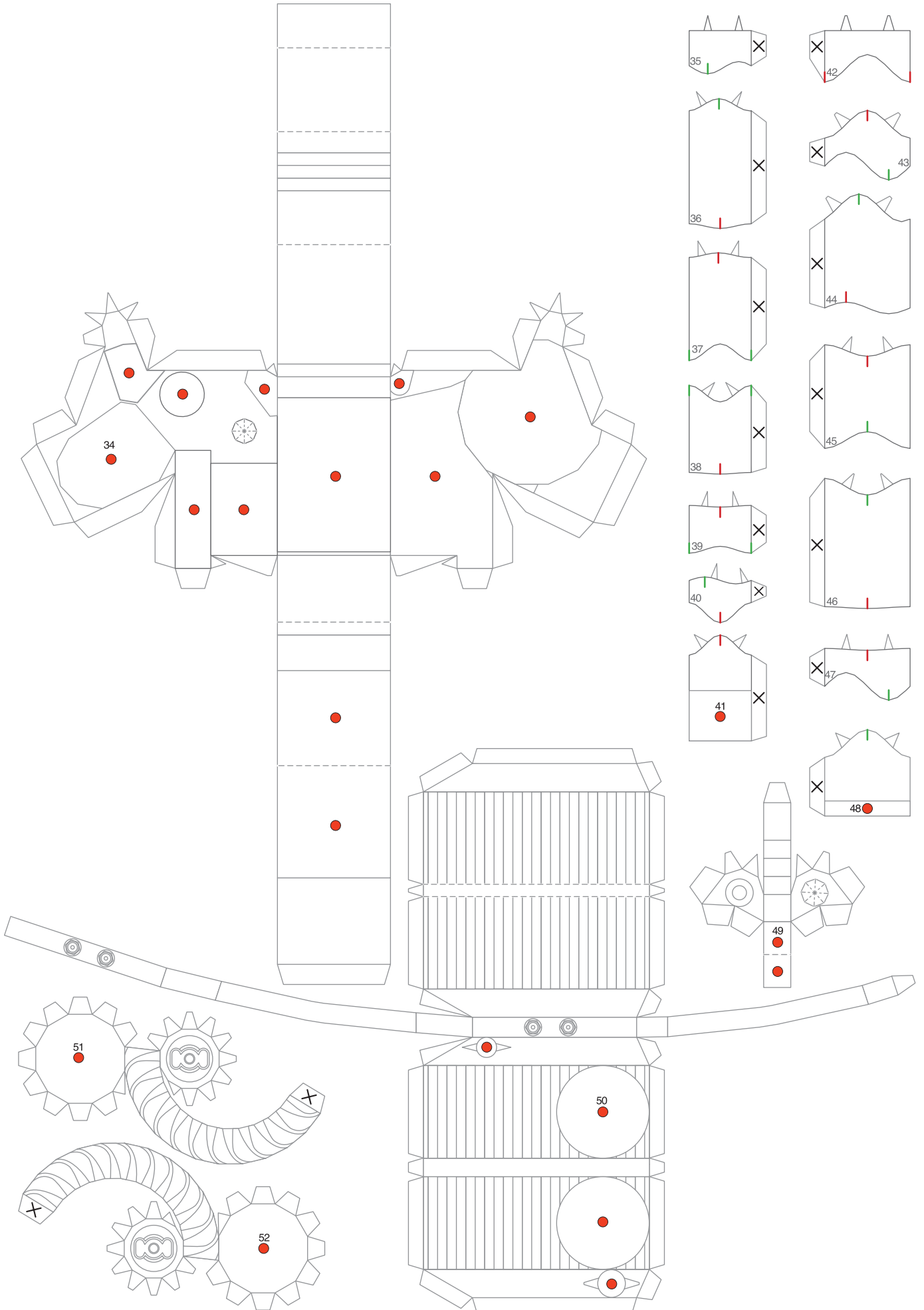

**K** Stand

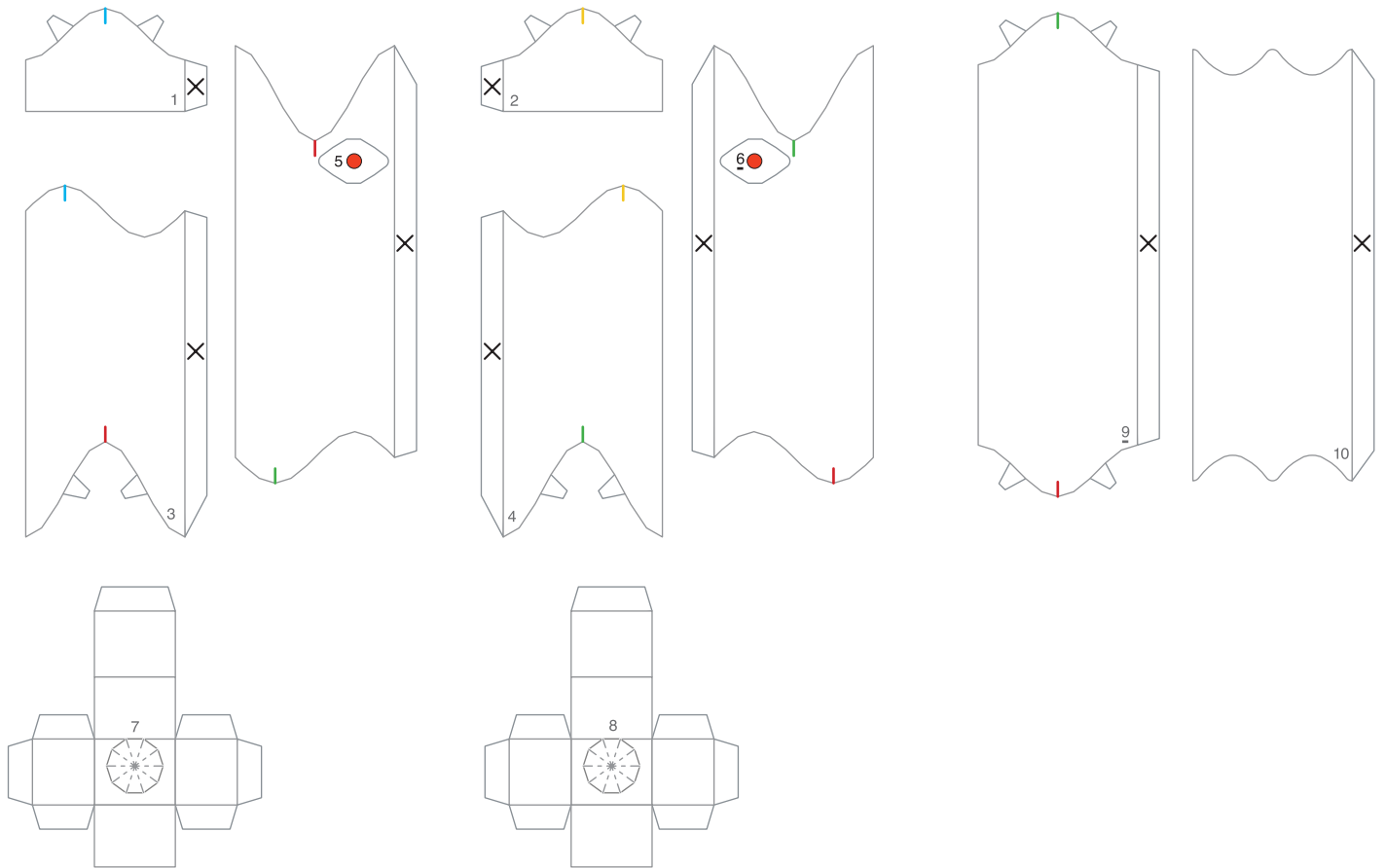

**L** Exhaust Pipes

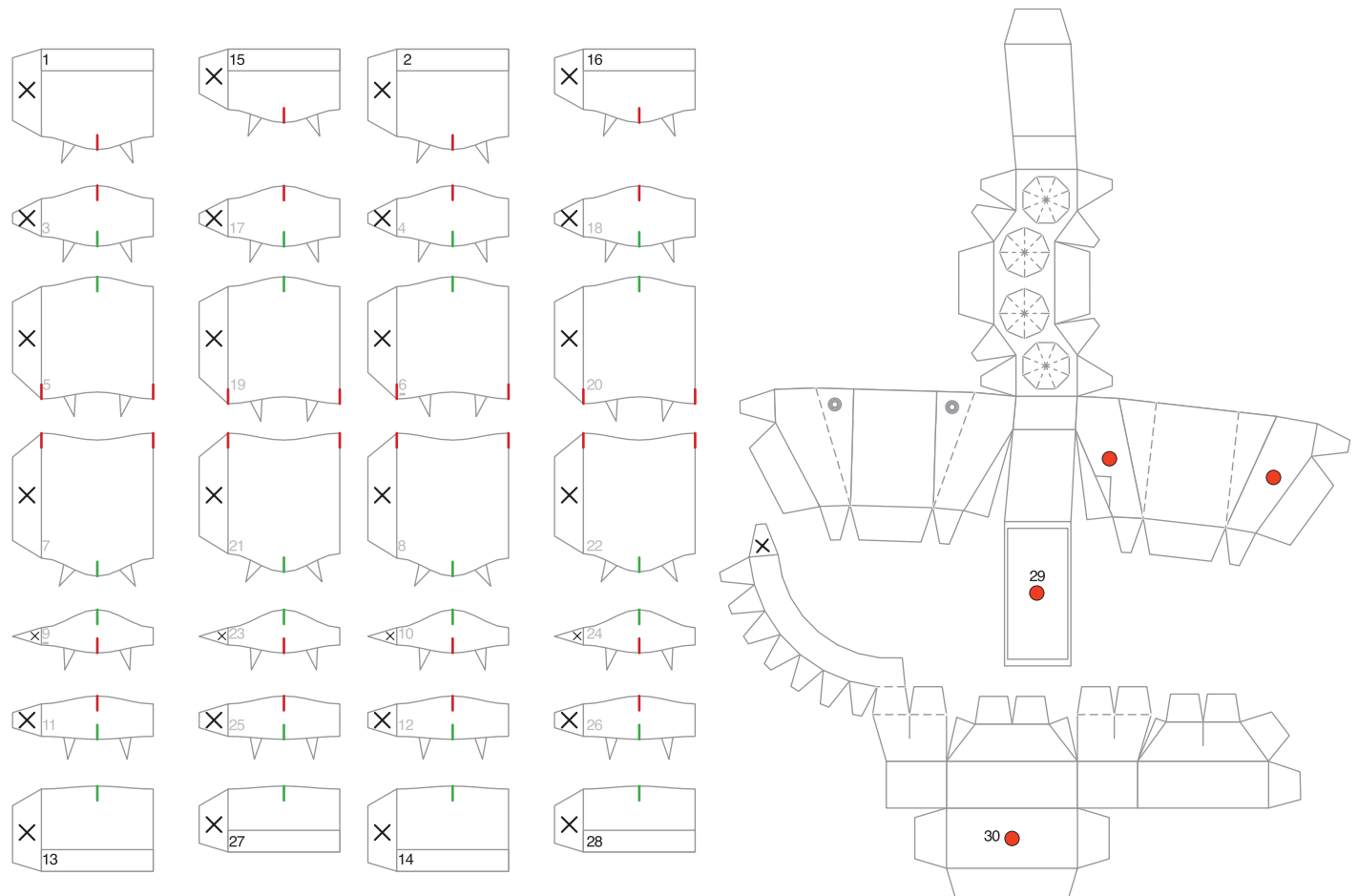



**L** Exhaust Pipes

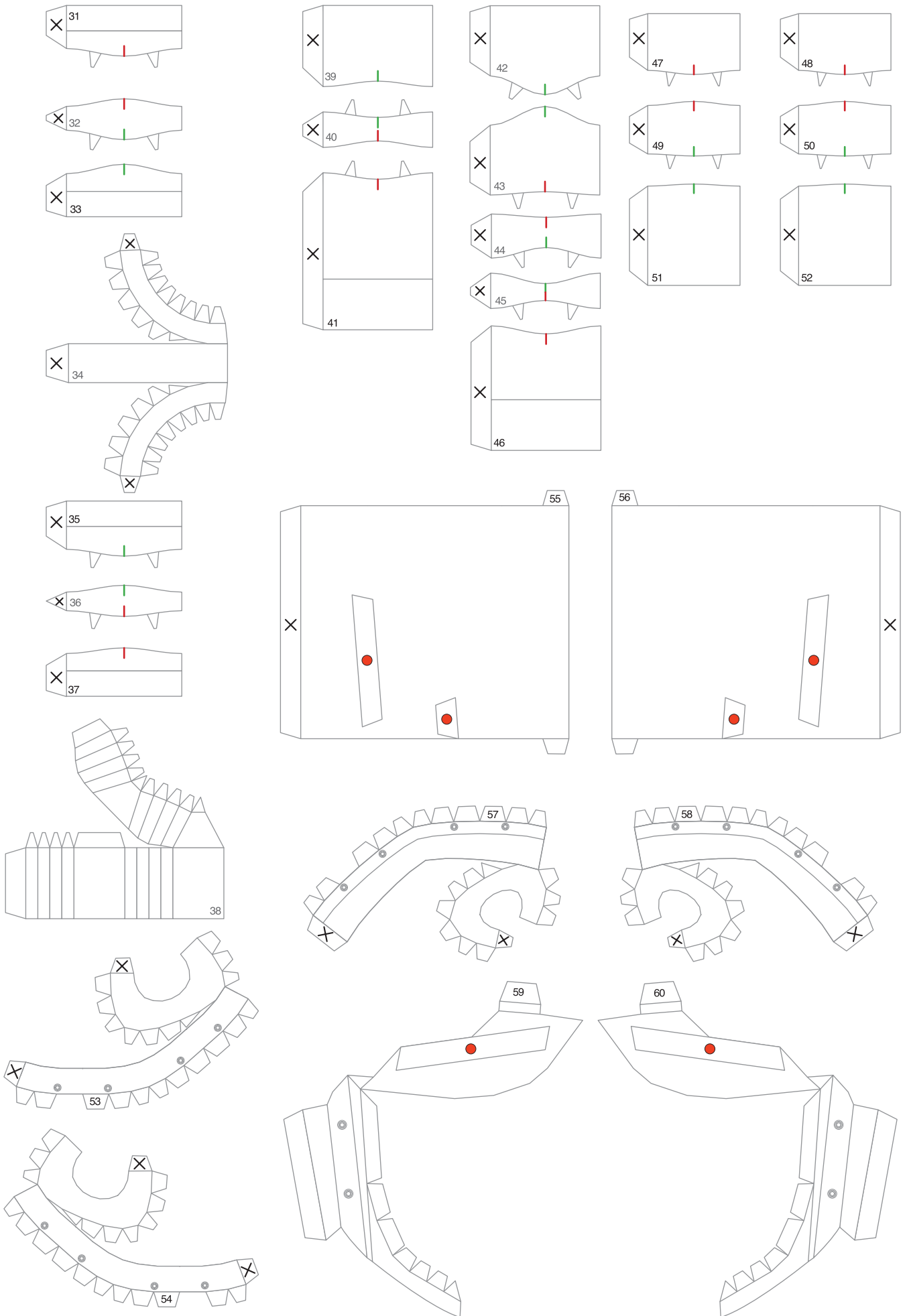

**M** Left footrests & Right footrests

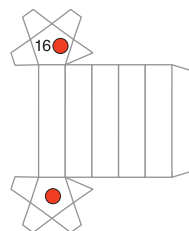
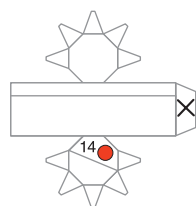
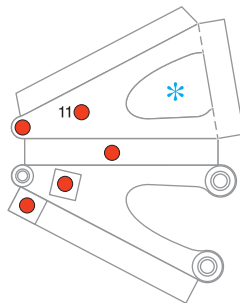
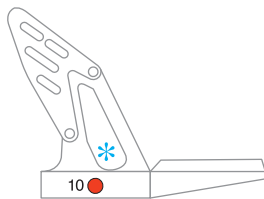
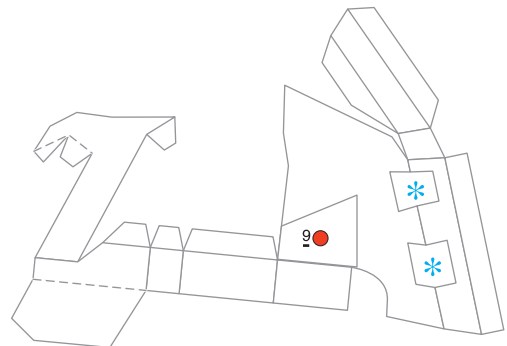
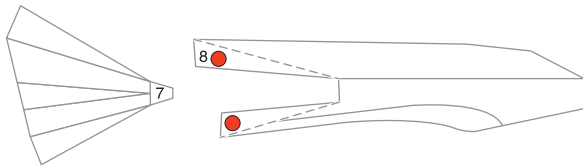
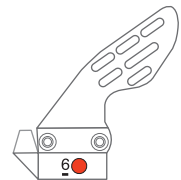
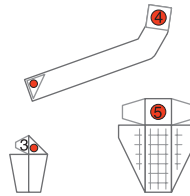
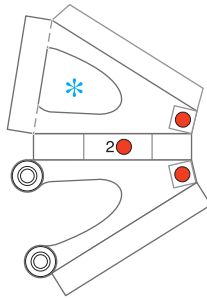
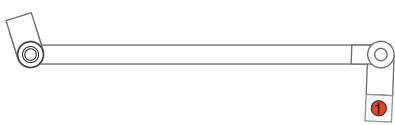

**N** Front wheel & Front Tire

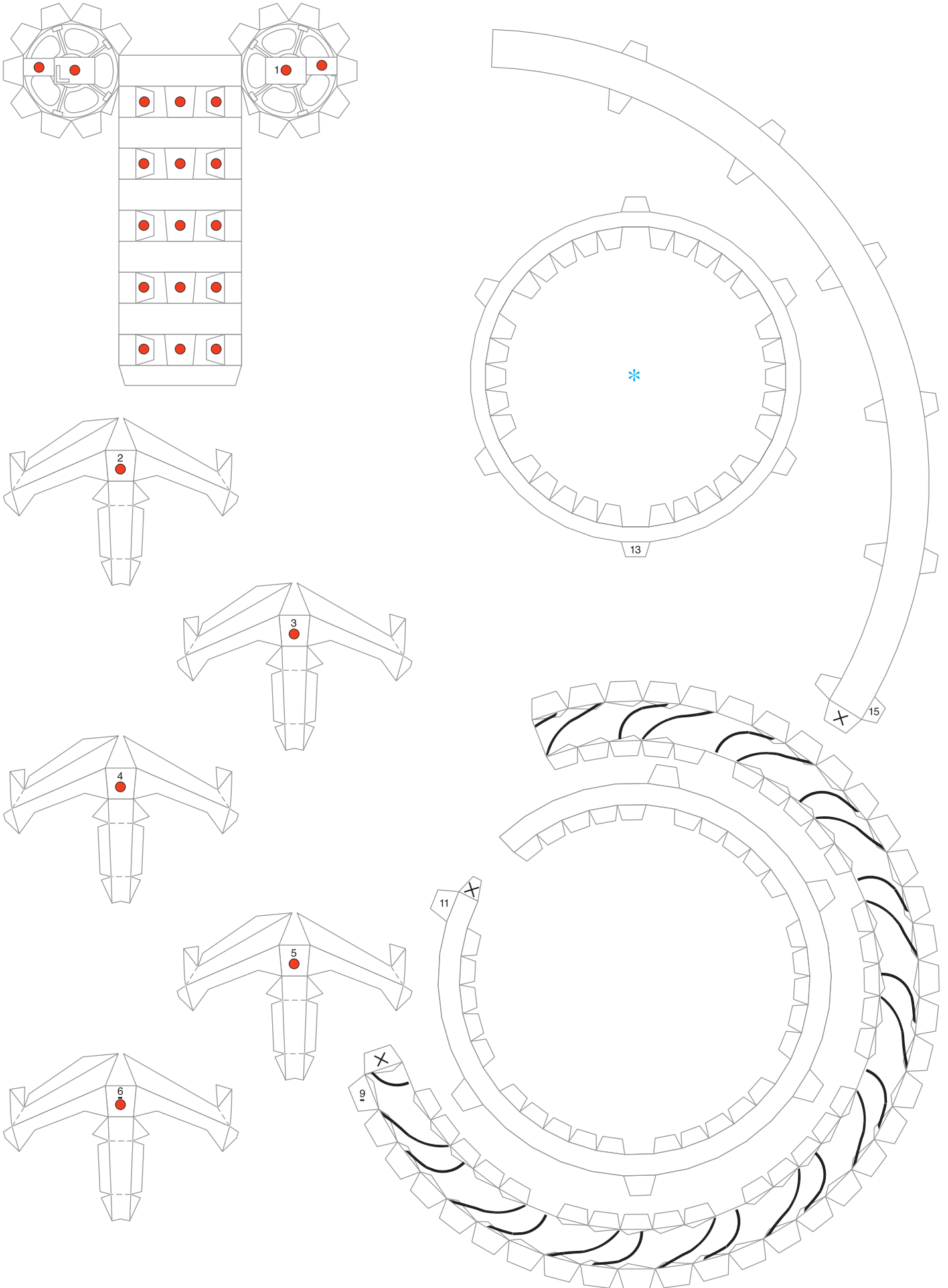

**N** Front wheel & Front Tire

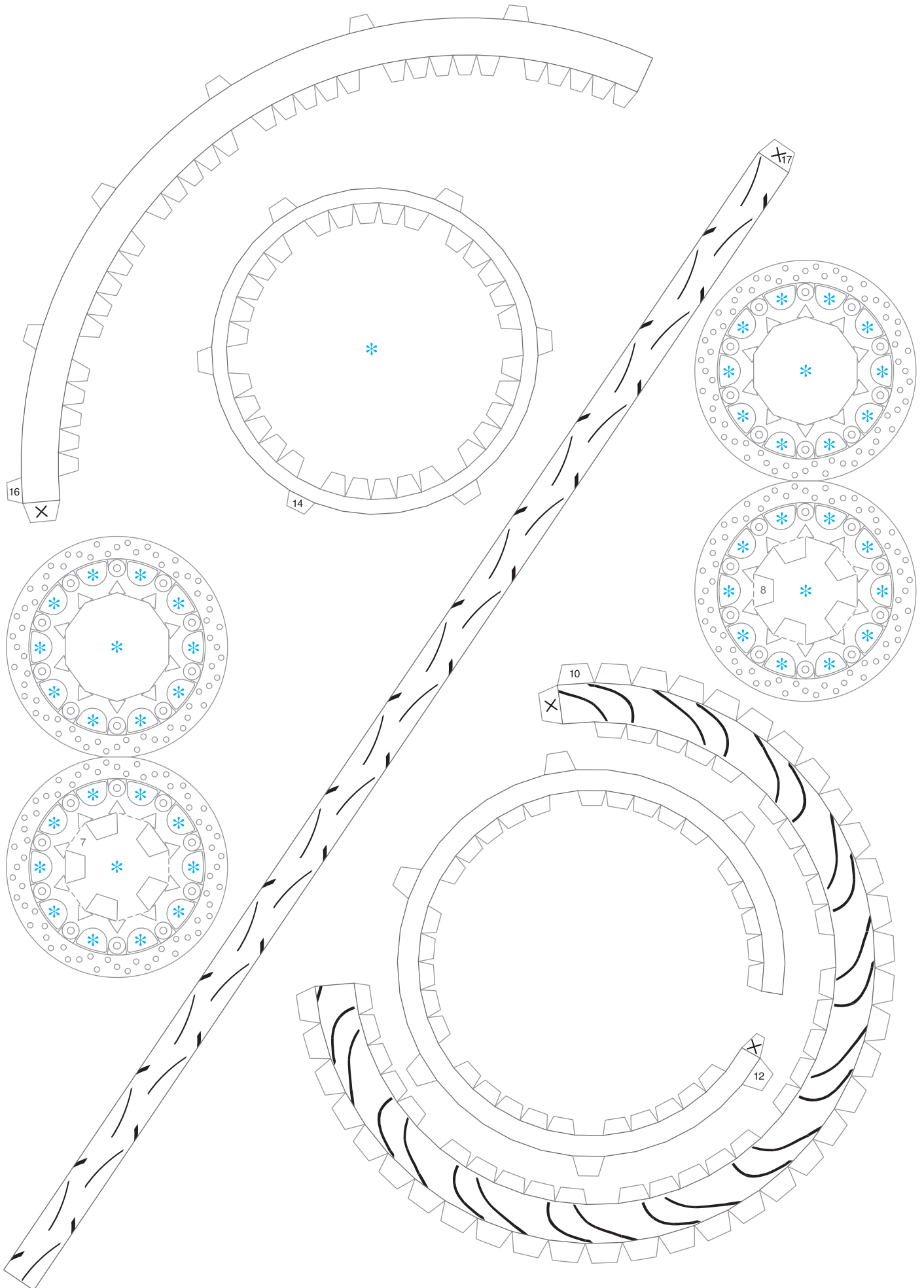

**O** Rear wheel & Rear Tire

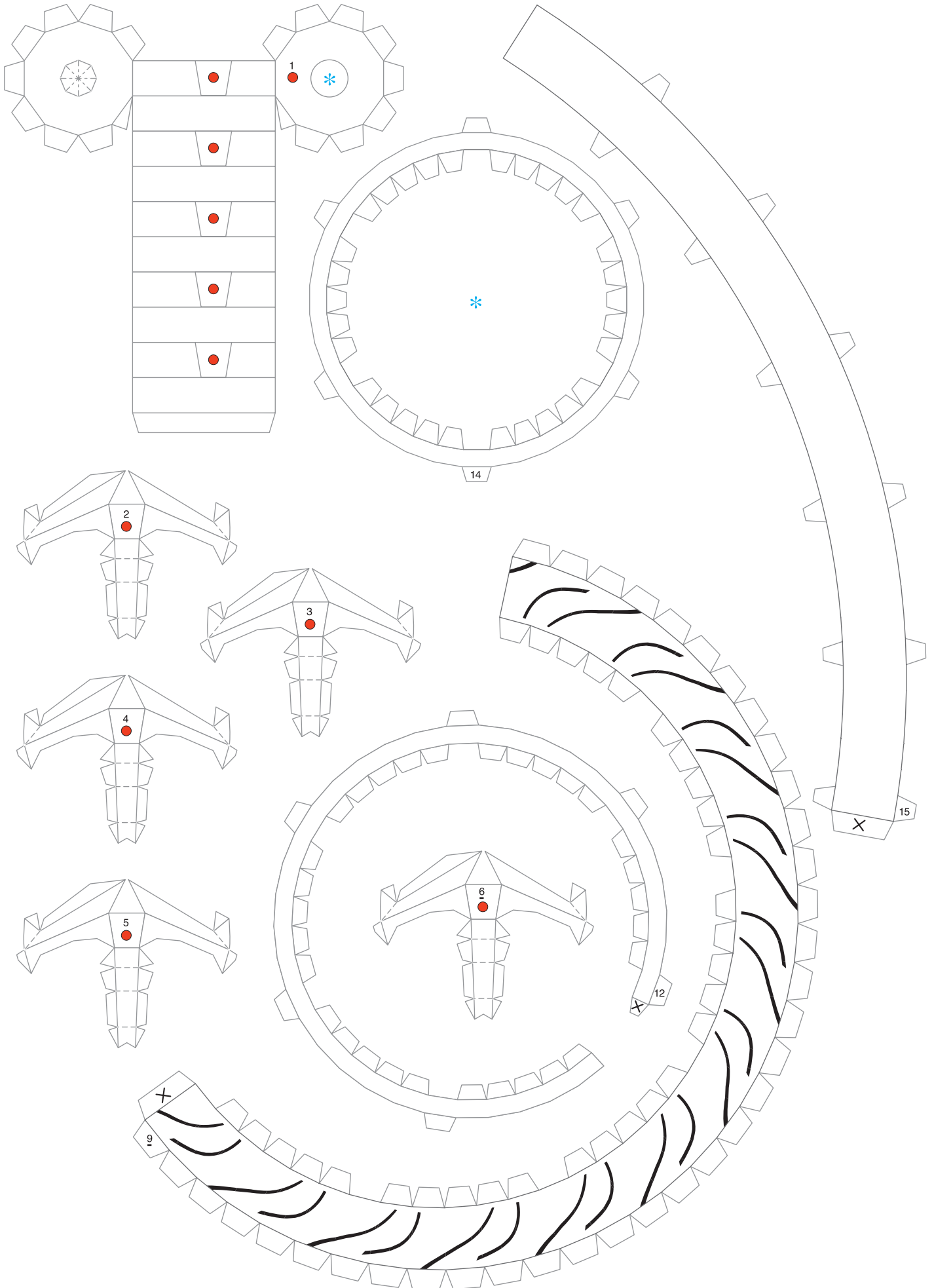

**O** Rear wheel & Rear Tire

