

# Pteranodon

This is a paper craft of a pteranodon in flight with its wings spread wide. The pteranodon is one of the most well-known winged dinosaurs. Believed to have existed in the late Cretaceous period of the Mesozoic era, pteranodons have large, distinctive crests, and a wingspan of around 7 to 9 meters. Display this paper craft by placing it on the stand included, or use string to hang it from the ceiling!

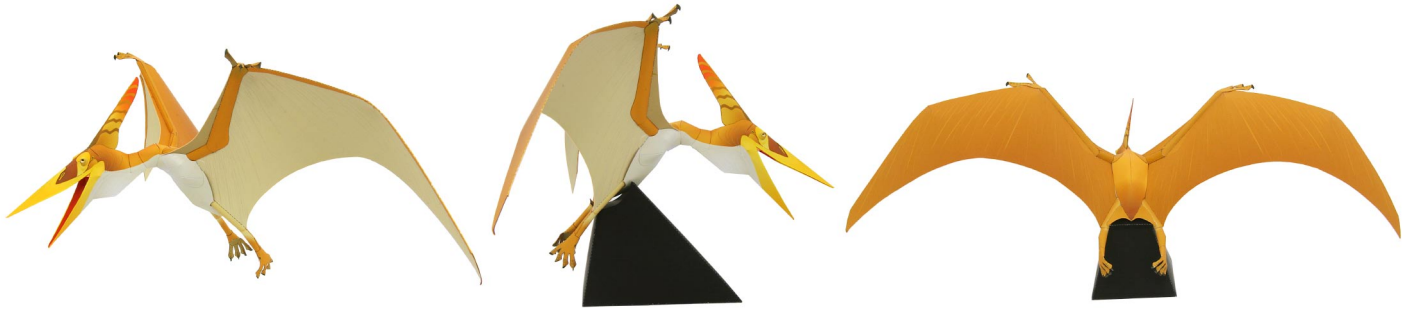

Assembly Instructions

- 1: Carefully cut out the parts.
- 2: Fold along the dotted lines, making mountain or valley folds as indicated.
- 3: Attach the glue tabs on each part to assemble the model. (Read the assembly instruction for more information.)
- 4: Attach the parts in order. (Read the assembly instruction for more information.)
- 5: Your paper craft model is finished!







Tools

Scissors, glue (We recommend craft glue.)

Caution

Keep scissors and glue away from small children.  
Be careful not to cut your fingers when using scissors.

Explanation of Symbols

-  Cut line
-  Valley fold
-  Mountain fold
-  Glue up to this line
-  Cut in line
-  Glue tab  
Attach to a point within the same piece
-  Glue tab  
Attach to a separate piece

Assemble the head

1. Add curves to ①, and assemble it.

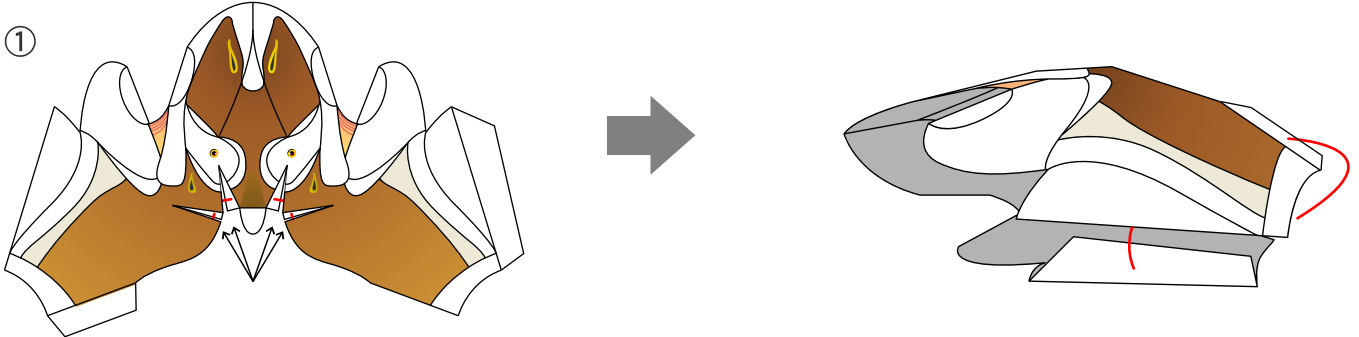

2. Assemble ②, and attach it to ①.

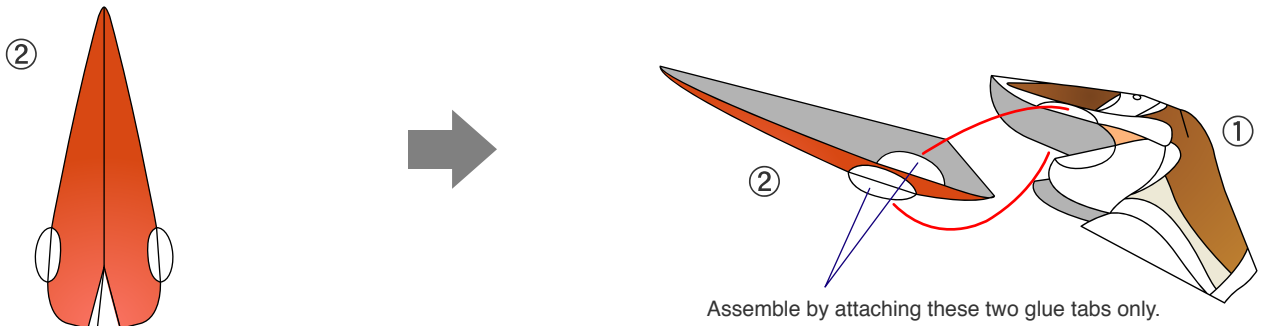

3. After assembling ④ and ⑤, attach them to ③. Then, fit it on to the head and attach it in place.

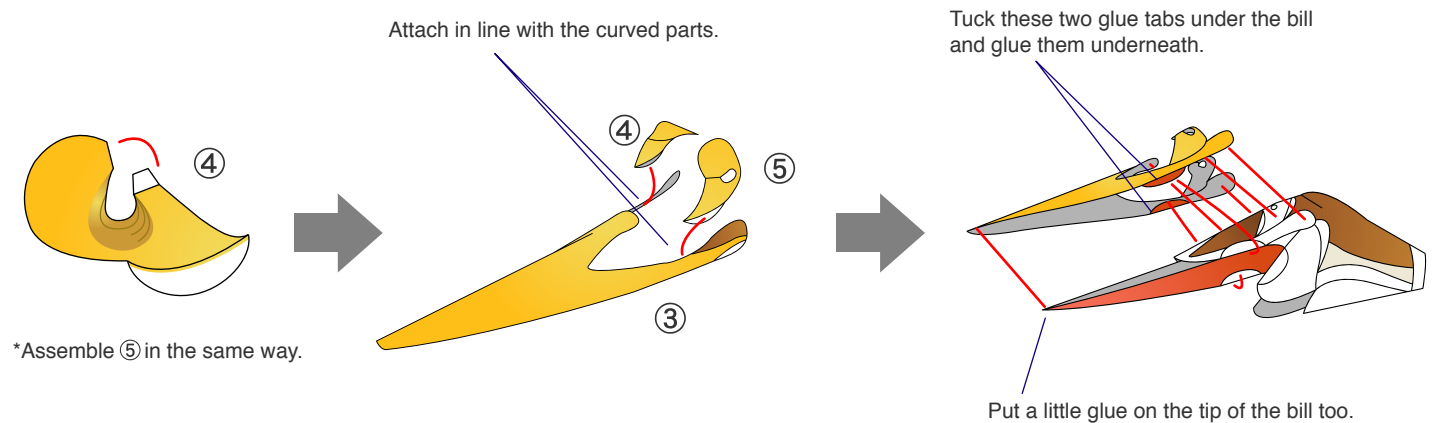

\*Assemble ⑤ in the same way.

4. Attach ⑥ to the head by inserting it inside. Then, assemble ⑦, fit it on to the head from the bottom and attach it in place.

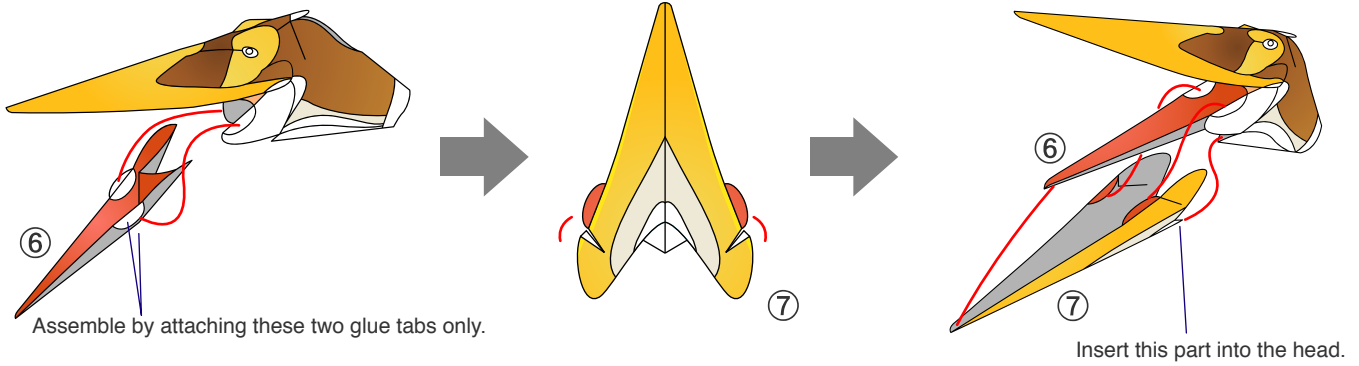

5. Assemble ⑧, and attach it to the head by inserting it inside.

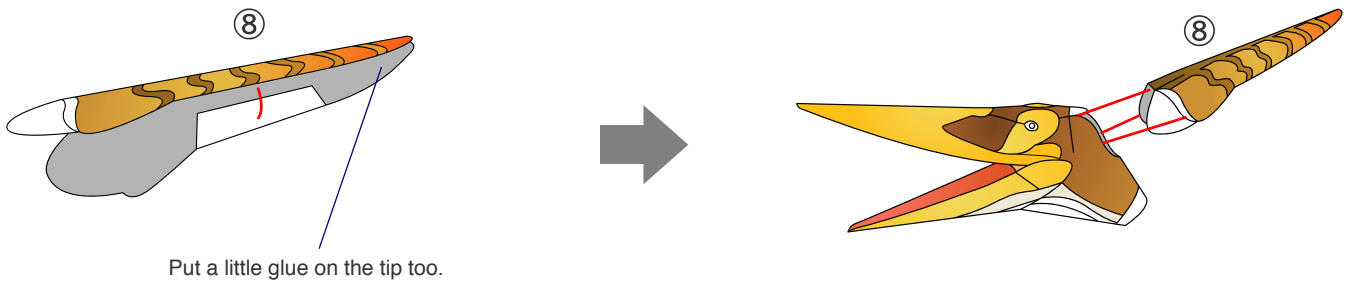

6. Assemble ⑨, ⑩ and ⑪, and attach to the head.

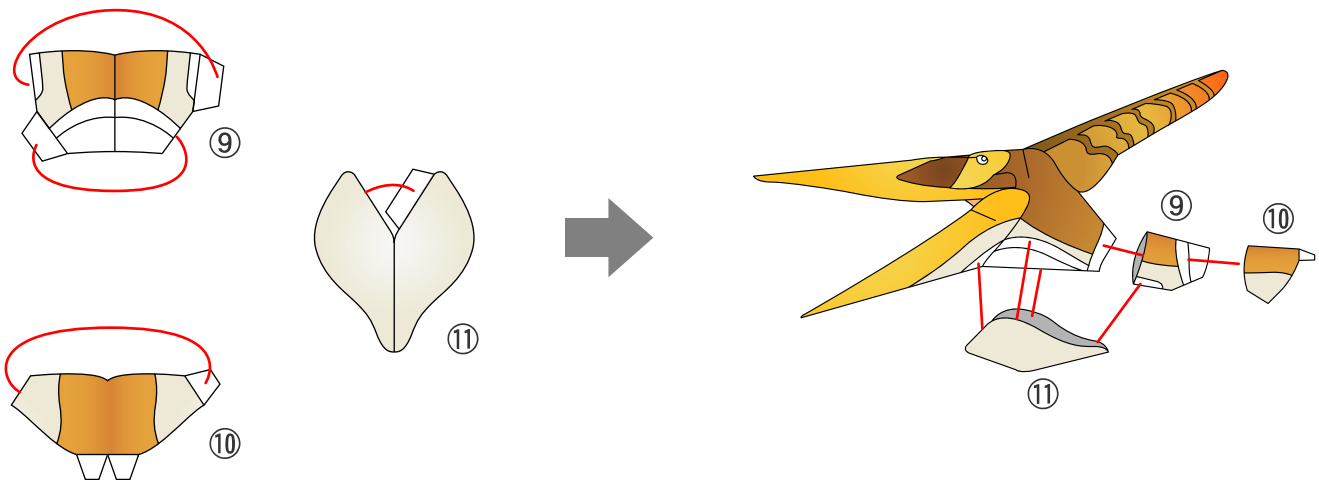

**Assemble the wings**

1. Assemble ⑫, and attach it to ⑬. Next, cut away the piece on ⑬ marked by the curved line.

After attaching the pieces together, fold these parts back and then glue them down.

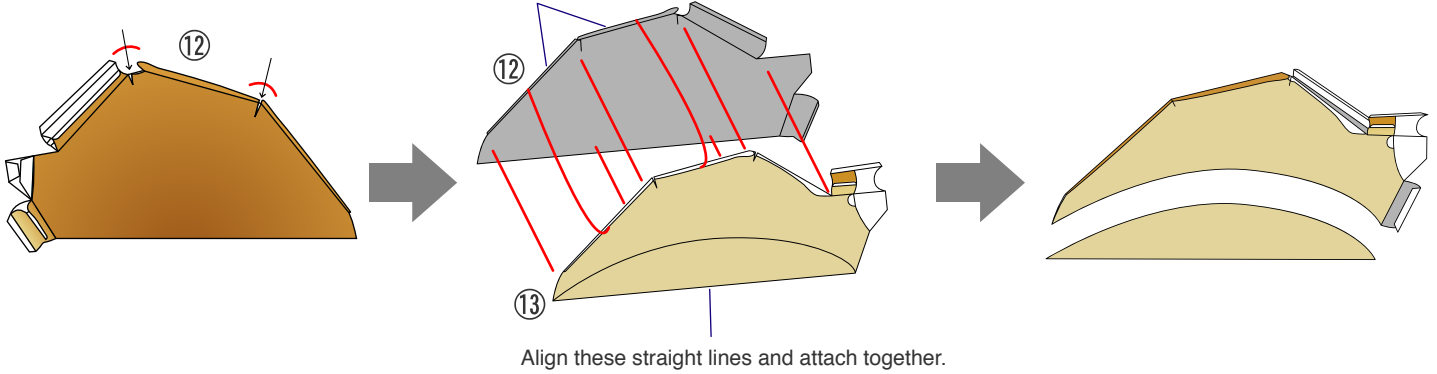

2. Roll the sections marked A, B and C and glue them to form cylinders.

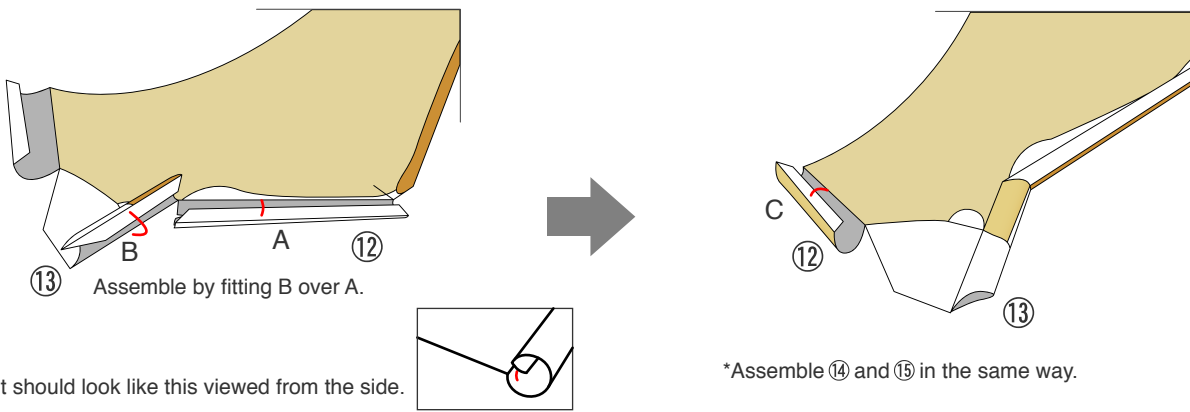

3. Attach the left and right wings together. Next, assemble ⑯, and glue it to the wings.

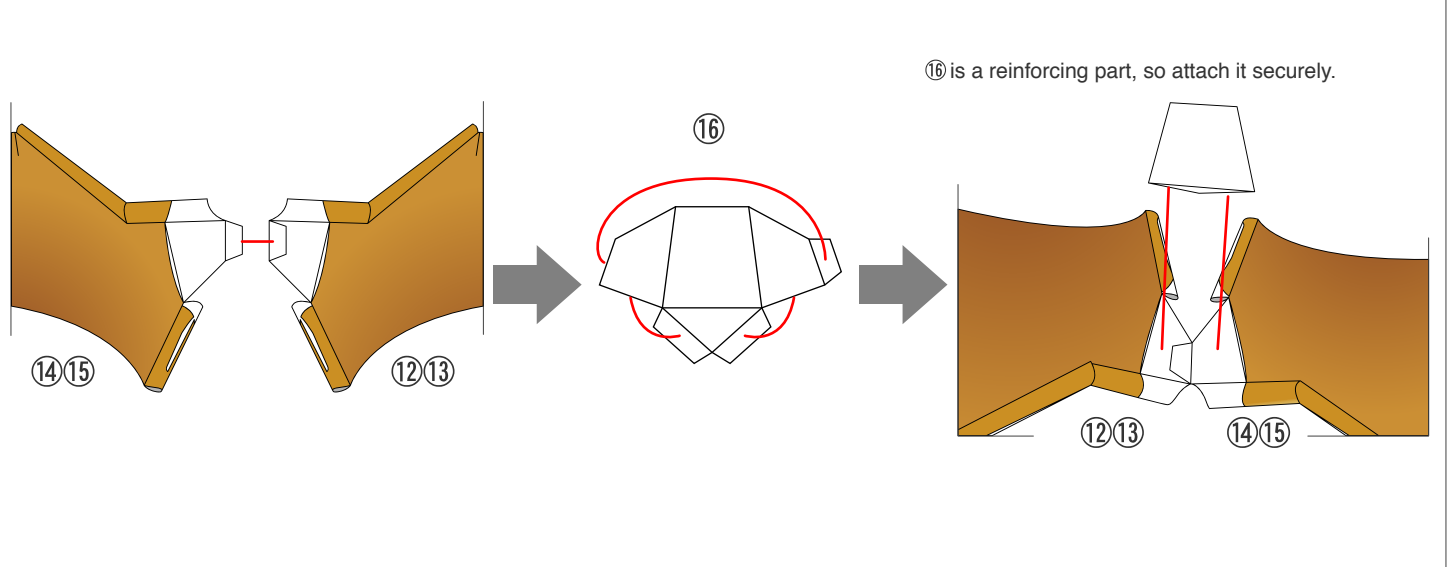

**Assemble the body**

1. After assembling ⑰, attach ⑱ and ⑲, and cut away the piece marked by the curved line.

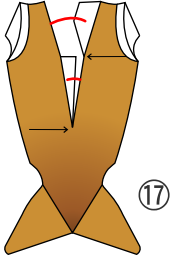

If you want to hang it up with string, thread the string through at the two points marked by arrows.

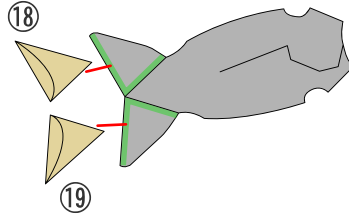

Glue firmly to the straight lines (marked here in green).

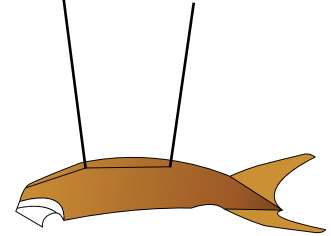

If you have threaded string, tie it up to keep it out of the way.

2. Assemble ⑳, and attach it to ⑰.

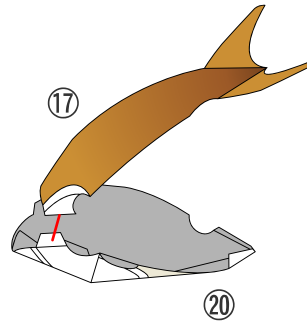
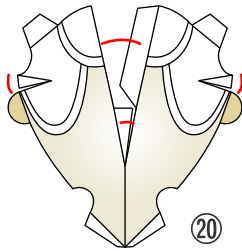

3. Attach ⑰ and ⑳ as shown, to the assembled wings.

First, attach the pieces at these two glue tabs only.

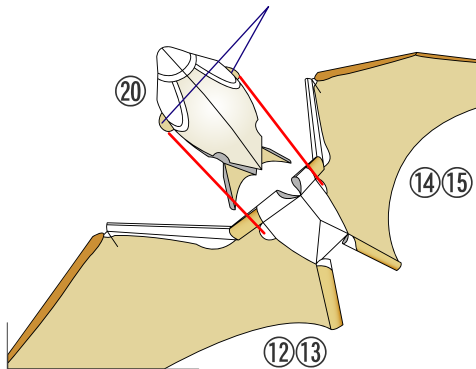

Turn it over, and attach the glue tabs together.

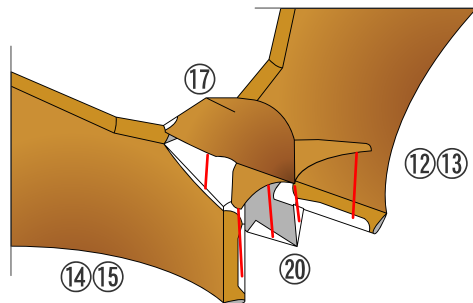

4. Assemble ⑳, and attach it to the body.

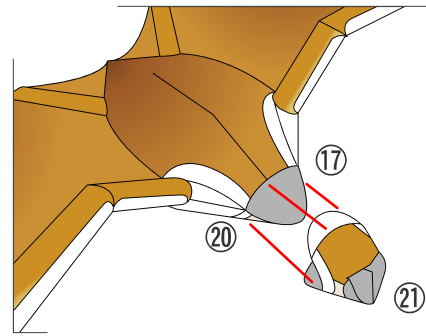
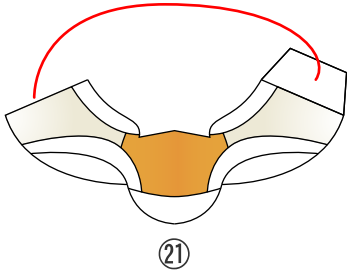

5. Assemble ㉒ and ㉓, and attach it to the body.

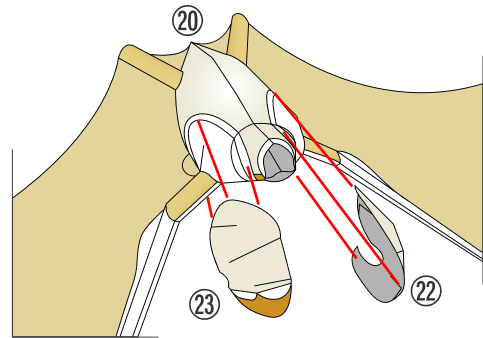
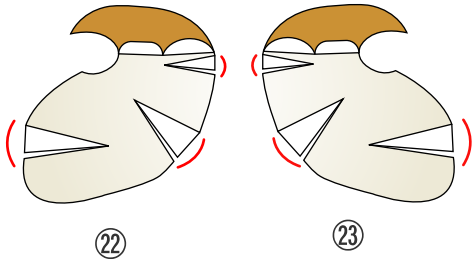

### Assemble the feet

1. After attaching ㉔ and ㉕, attach them to the wings.

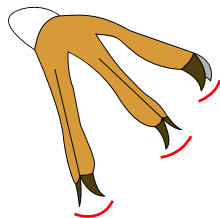
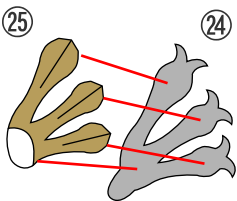

Glue the tips of the claws together too.

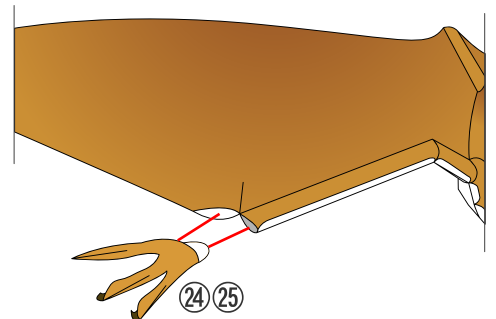

\*Assemble ㉗ and ㉘ in the same way.

2. After assembling 26, cut away the piece marked by the curved line.

Do not put glue on these areas.

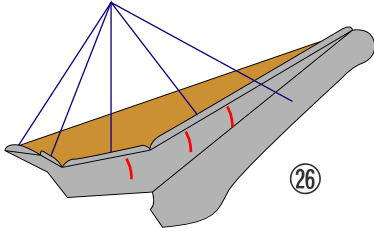

26

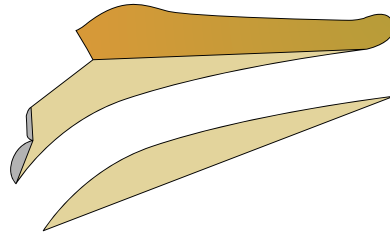

\*Assemble 29 in the same way.

3. Attach 26 and 29 to the wings, and attach the head to the body.

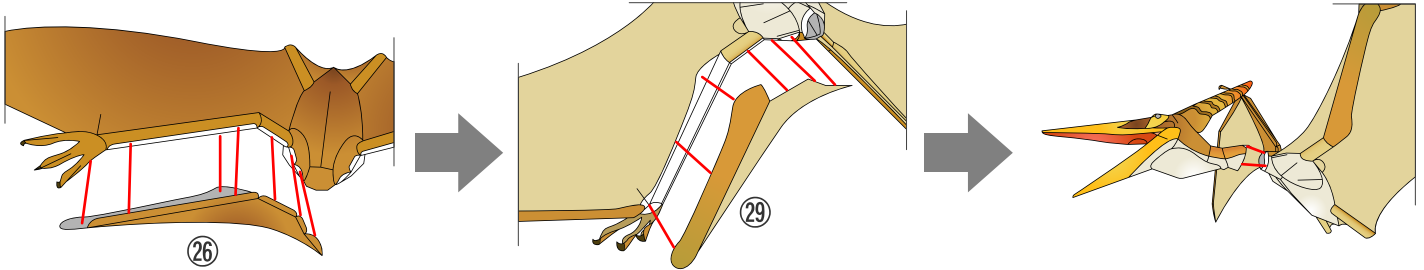

26

29

4. Attach 30 and 31 together.

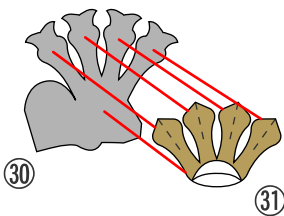

30

31

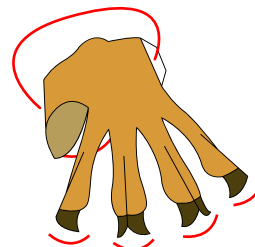

Glue the tips of the claws together too.  
\*Assemble 33 and 34 in the same way.

5. Assemble ③②, and attach it to ③①.

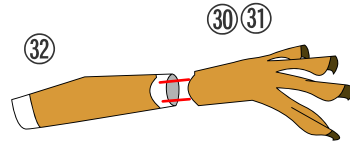
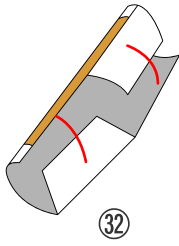

\*Assemble ③⑤ in the same way.

6. Attach the legs to the body, and your pteranodon is complete.

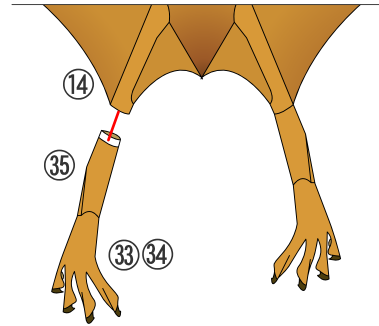
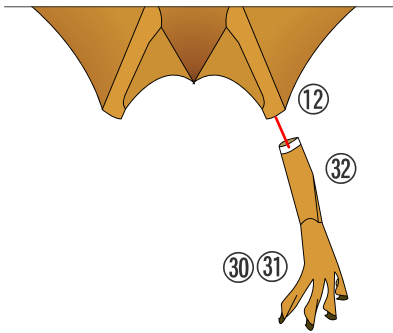

### Assemble the stand

1. Attach ③⑥, ③⑦ and ③⑧, place the pteranodon on top, and you're done!

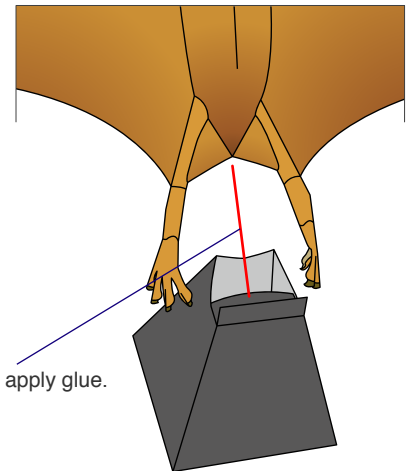
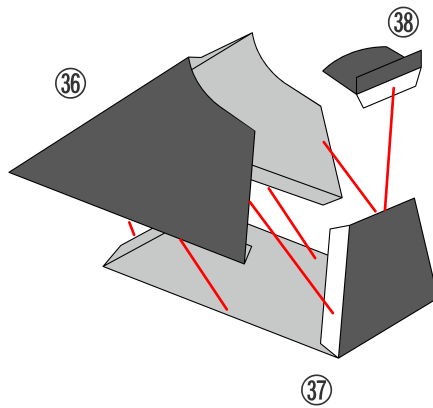
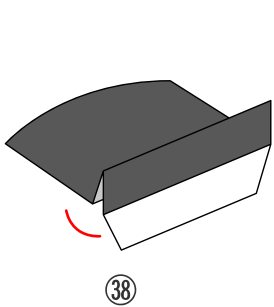

\*Do not apply glue.