

CREATIVE PARK

<http://www.canon.com/c-park/>

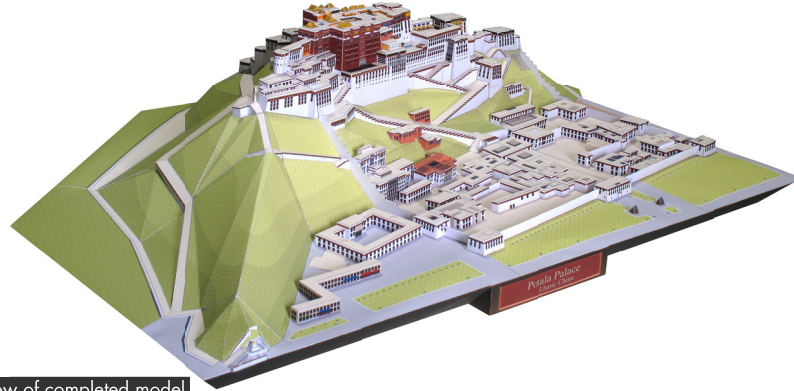

View of completed model

* This model was designed for Papercraft and may differ from the original in some respects.

Assembly Instructions : Forty five A4 sheets (No. 1 to No. 45)

* Build the model by carefully reading the Assembly Instructions, in the parts sheet page order.

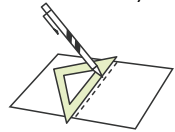

*Hint: Trace along the folds with a ruler and an exhausted pen (no ink) to get a sharper, easier fold.

Assembly Instructions



Mountain fold(dotted line)
Make a mountain fold.



Valley fold(dashed and dotted line)
Make a valley fold.

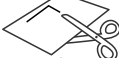

Scissors line(solid line)
Cut along the line.



Cut in line(solid line)
Cut along the line.



Glue
The glue spot(colored dot) shows where to apply the glue.



Glue spot(Red dot)
Glue parts with the same number together.



Glue spot(Green dot)
Glue within the same part.



Glue spot(Blue dot)
Glue to the rear of the other part.

Tools and materials



Scissors, set square, glue(We recommend stick glue), pencil, used ballpoint pen, toothpicks, tweezers, (useful for handling small parts)

Assembly tip



Before gluing, crease the paper along mountain fold and valley fold lines and make sure rounded sections are nice and stiff.

Caution



Glue, scissors and other tools may be dangerous to young children so be sure to keep them out of the reach of young children.

Before starting assembly :
Writing the number of each section on its back side before cutting out the sections is highly recommended.
(* This way, you can be sure which section is which even after cutting out the sections.)

→ Indicates where sections should be glued together.

A. Red Palace / White Palace

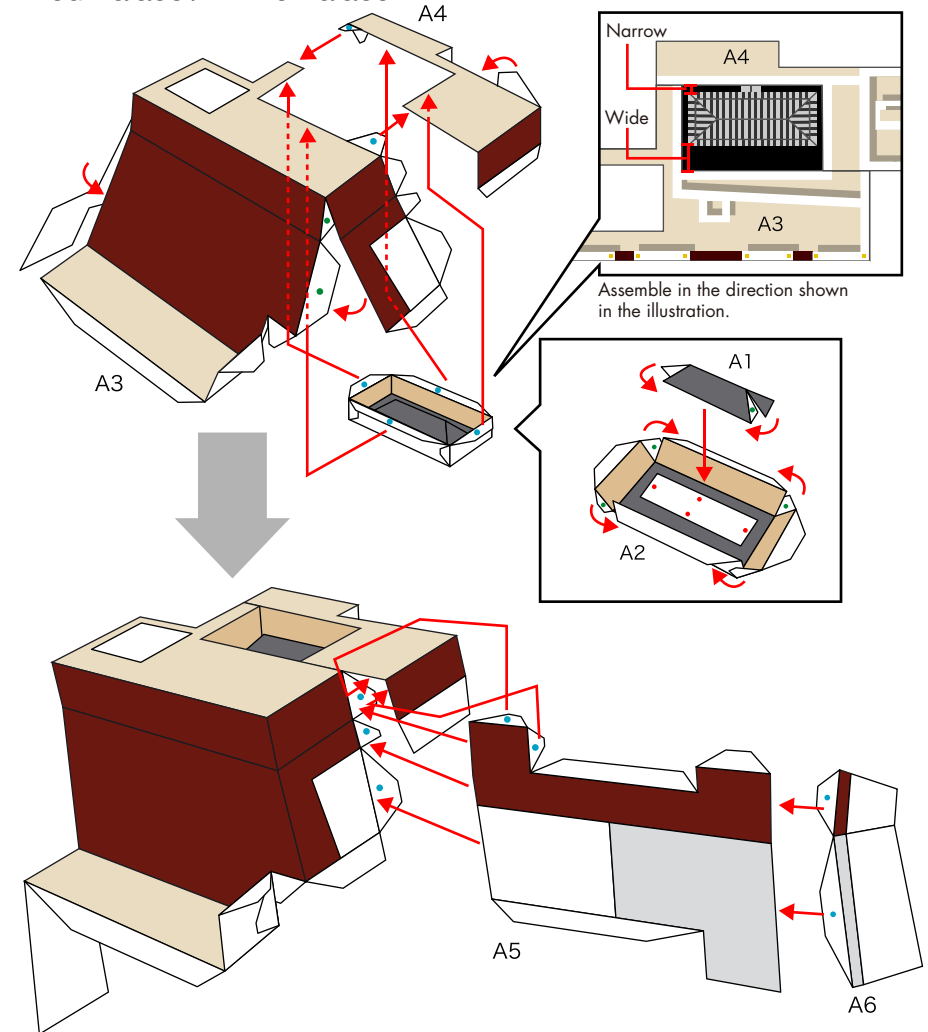

Potala Palace, China : Assembly Instructions

A. Red Palace / White Palace

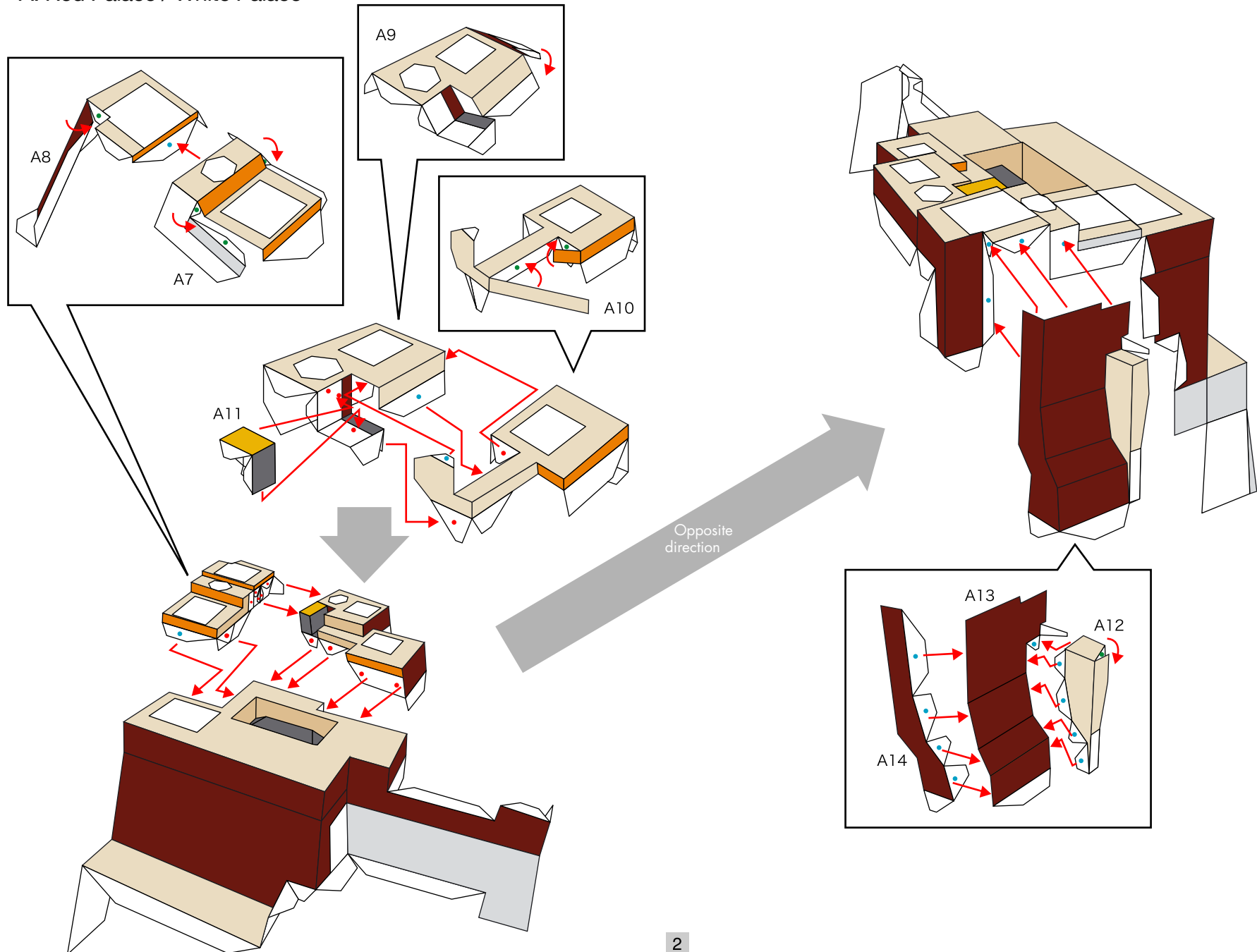

Potala Palace, China : Assembly Instructions

A. Red Palace
/ White Palace

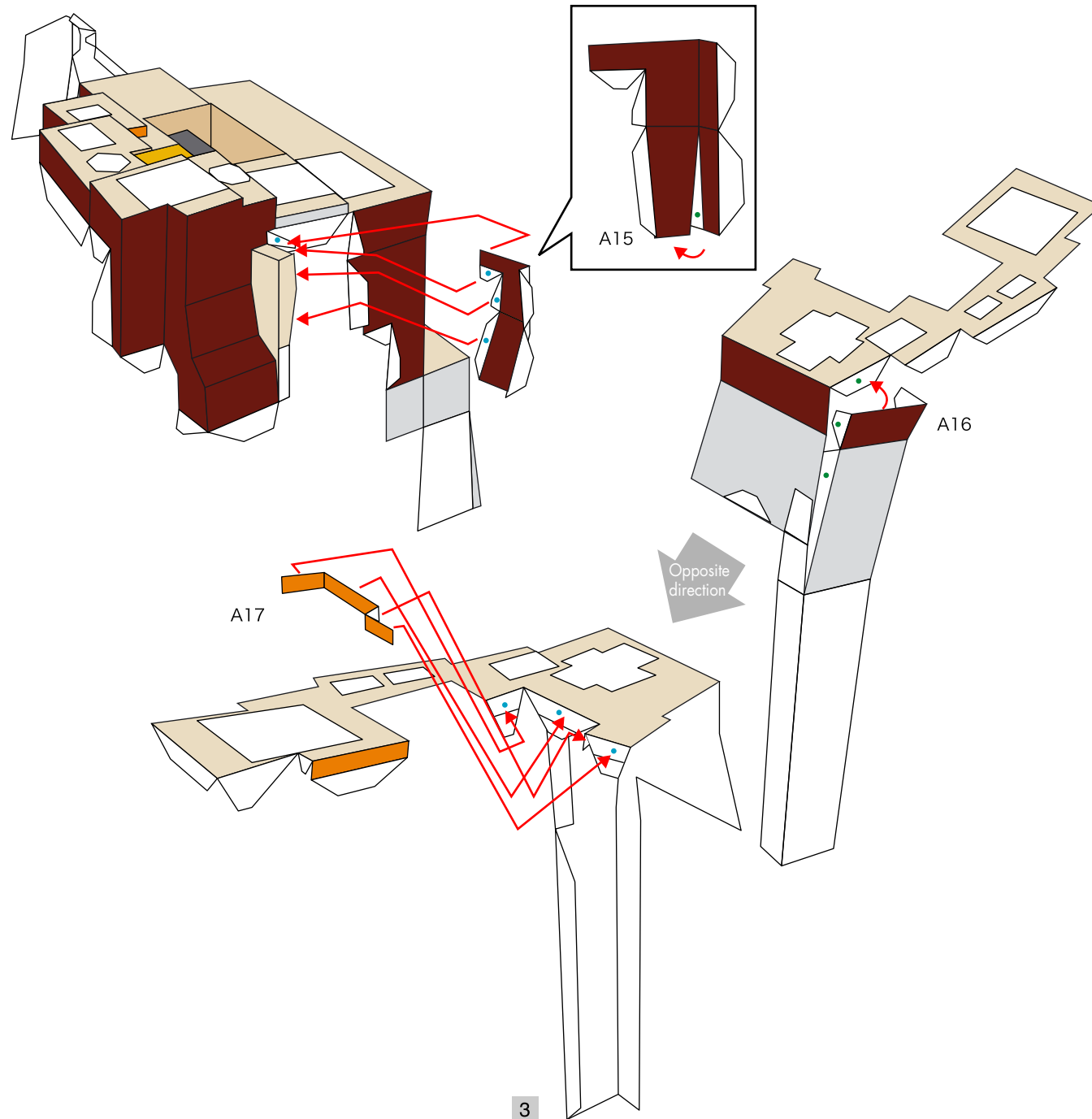

Potala Palace, China : Assembly Instructions

© Canon Inc. © T.Ichiyama



A. Red Palace / White Palace

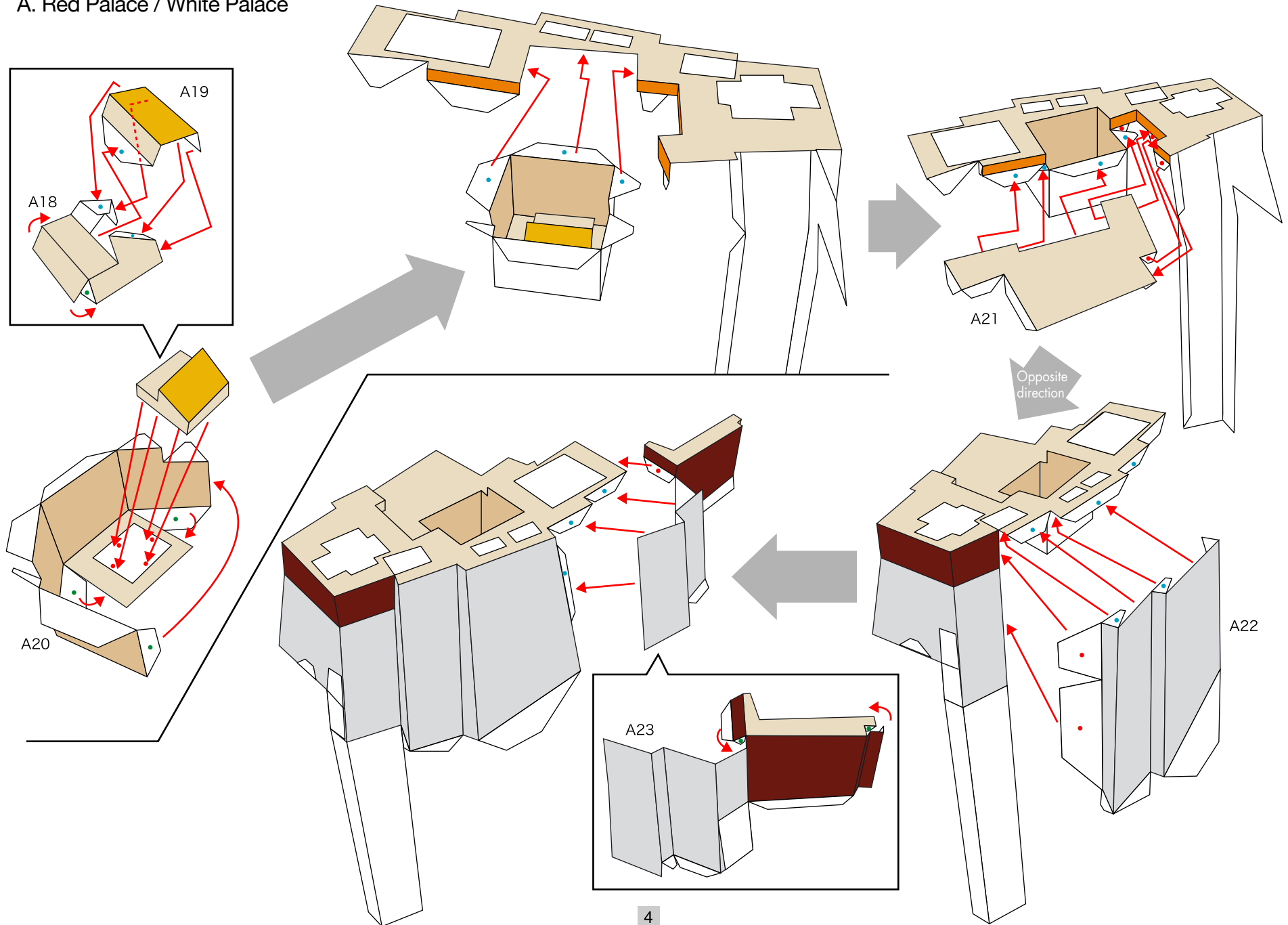

Potala Palace, China : Assembly Instructions

© Canon Inc. © T.Ichiyama



A. Red Palace / White Palace

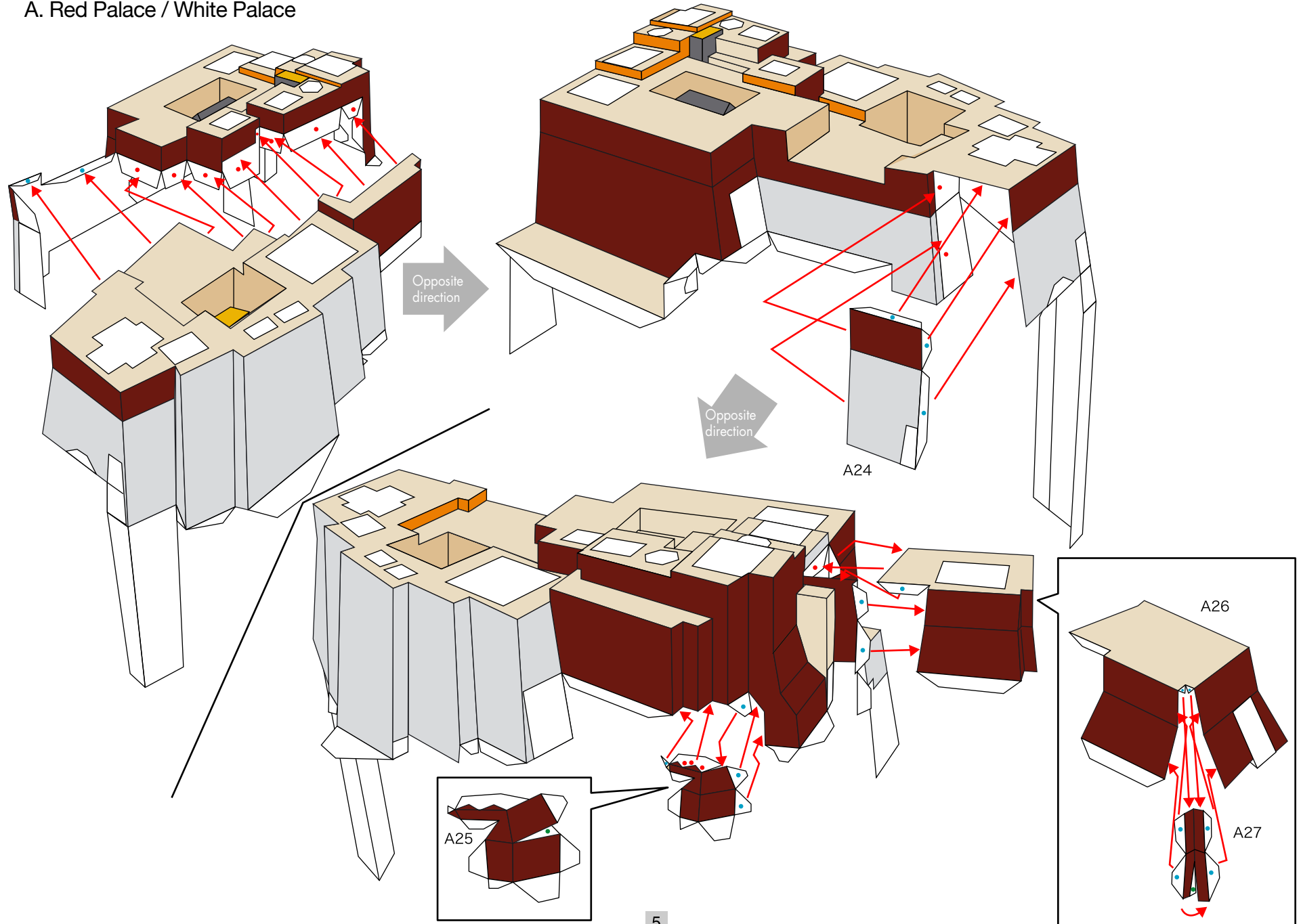

A. Red Palace / White Palace

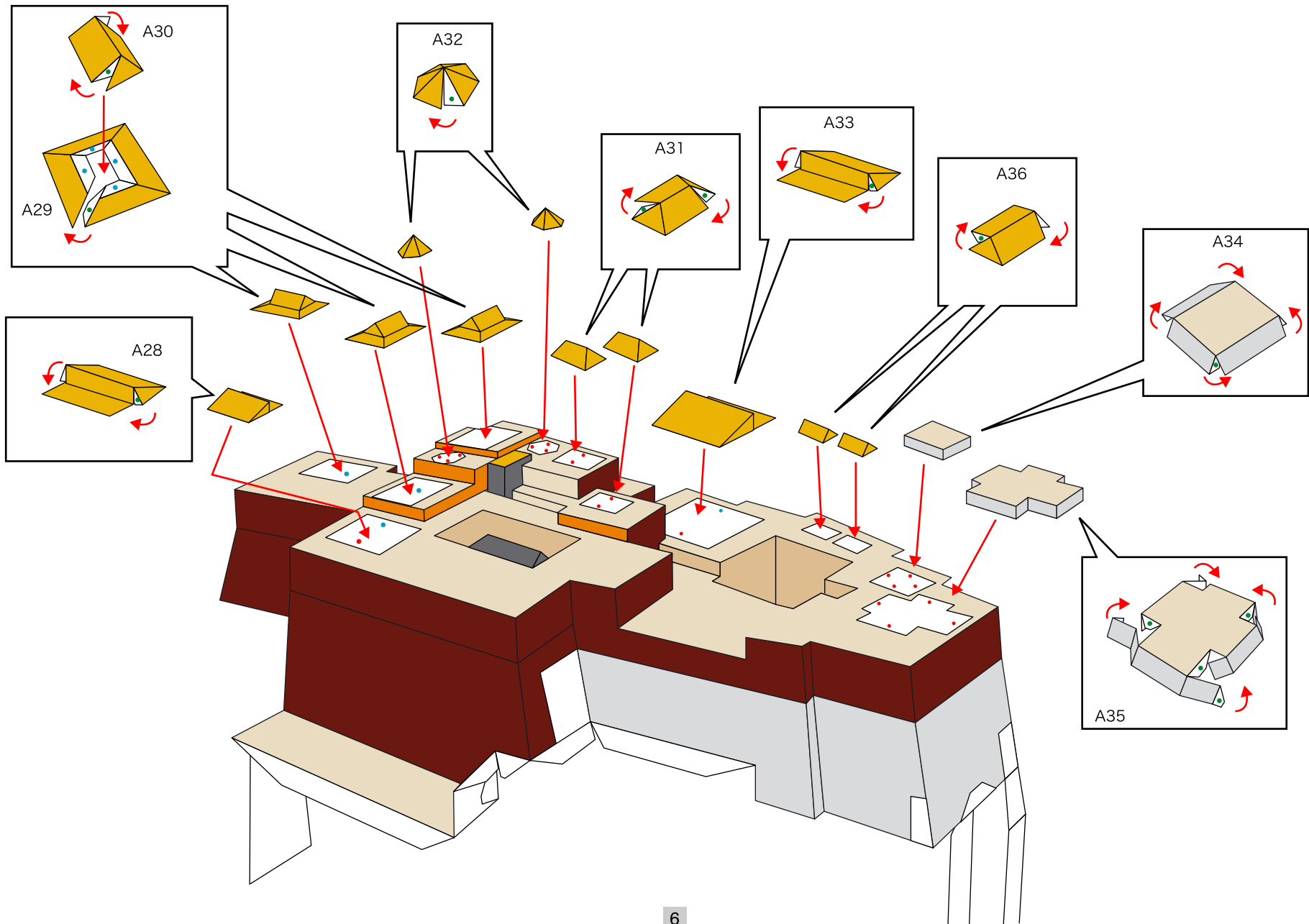

B. East Garden / West Garden

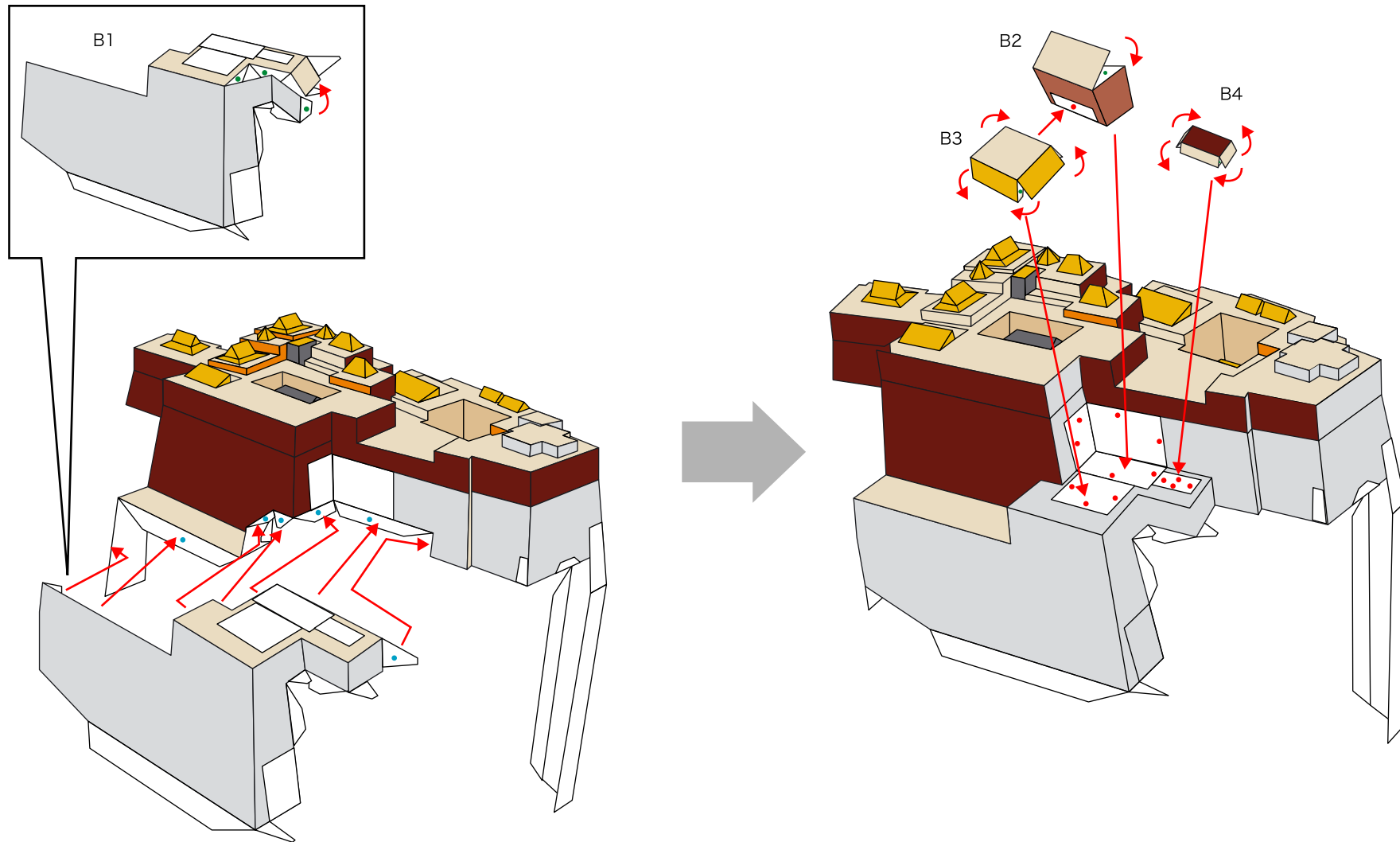

Potala Palace, China : Assembly Instructions

© Canon Inc. © T.Ichihama



B. East Garden / West Garden

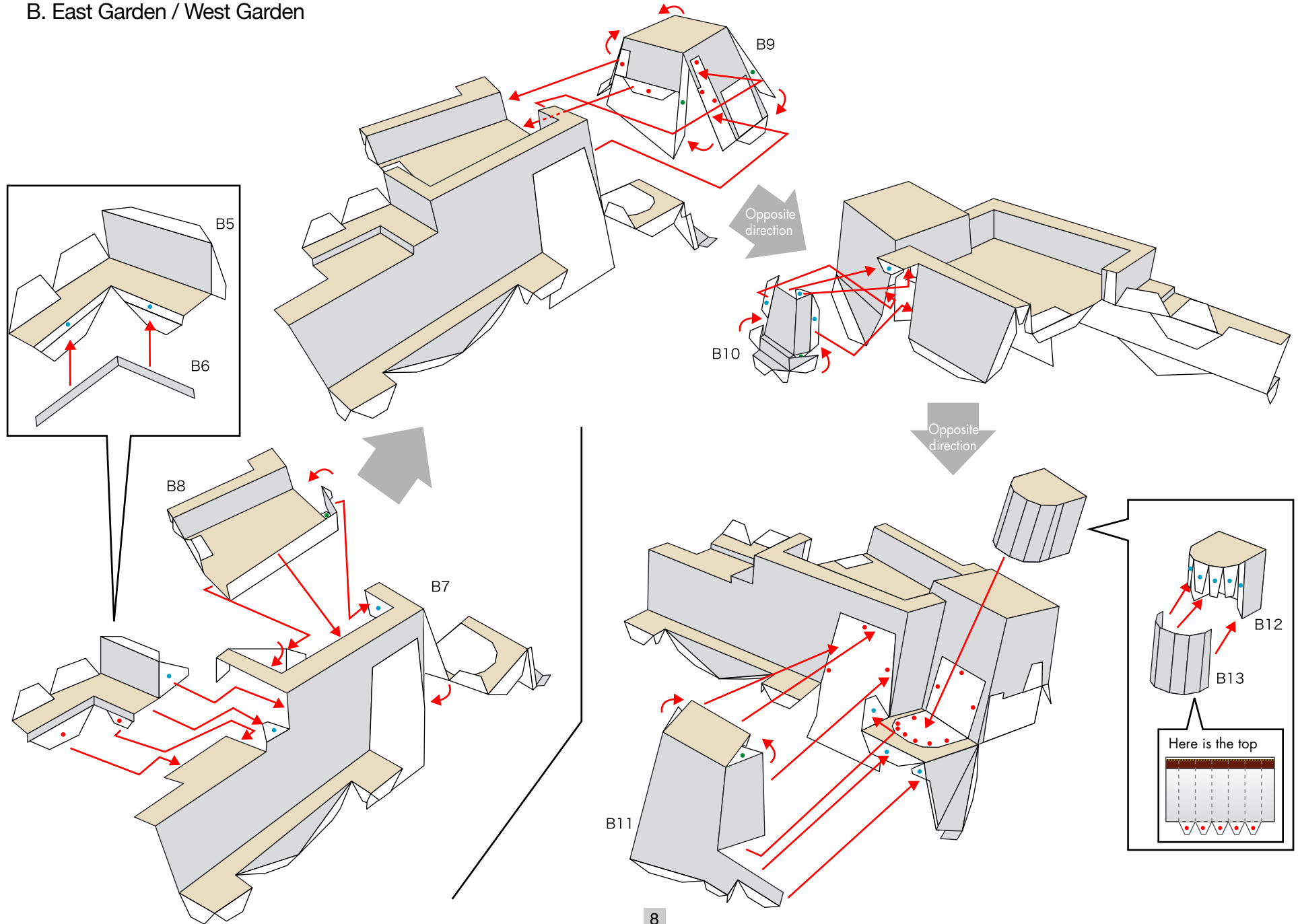

Potala Palace, China : Assembly Instructions

© Canon Inc. © T.Ichiyama



B. East Garden / West Garden

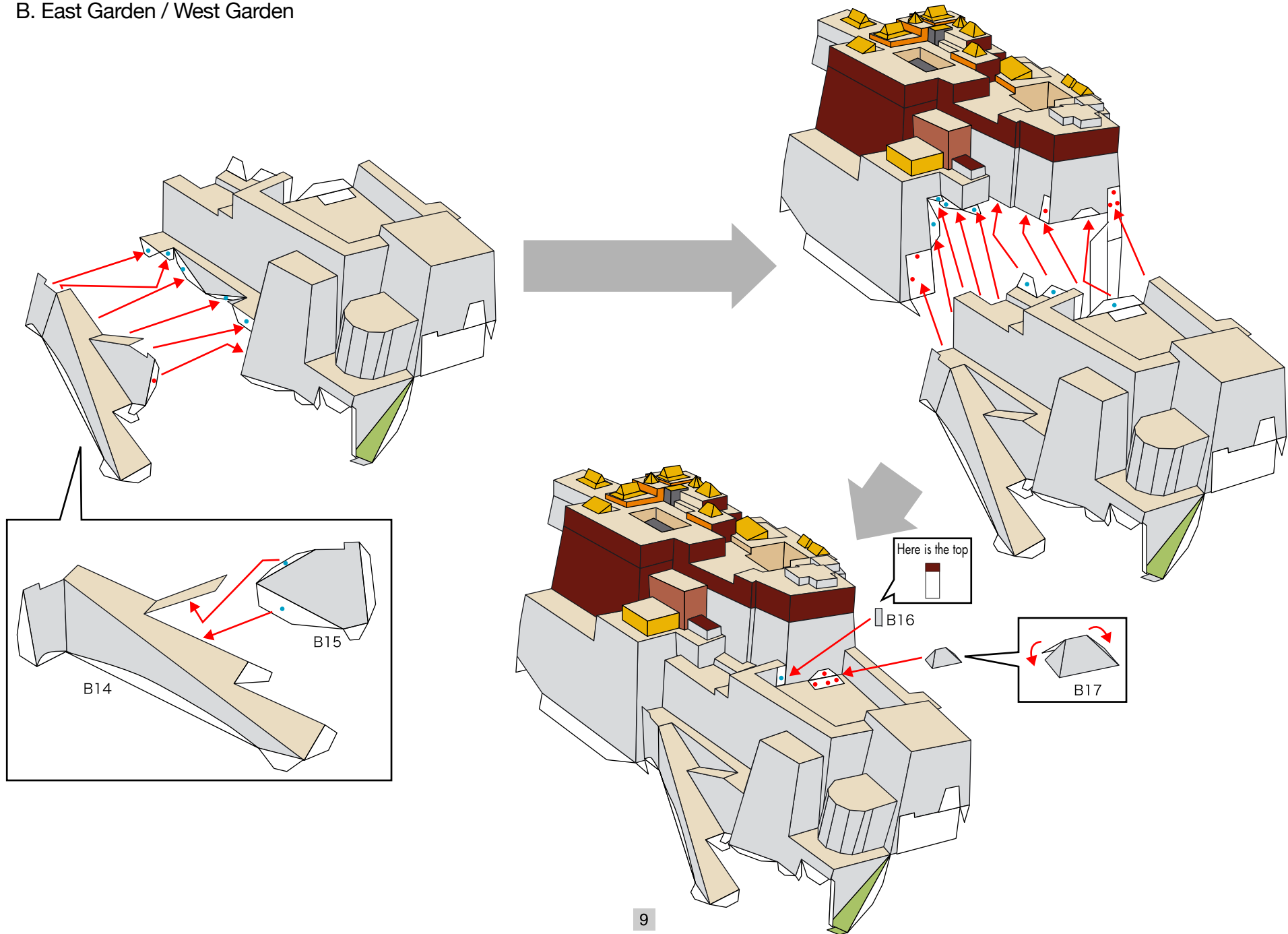

Potala Palace, China : Assembly Instructions

© Canon Inc. © T. Ichiyama



C. Jie Bu Jiao / Shang Kong Xia / Xi Yuan Bao

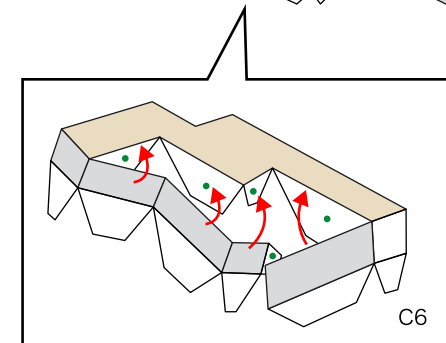
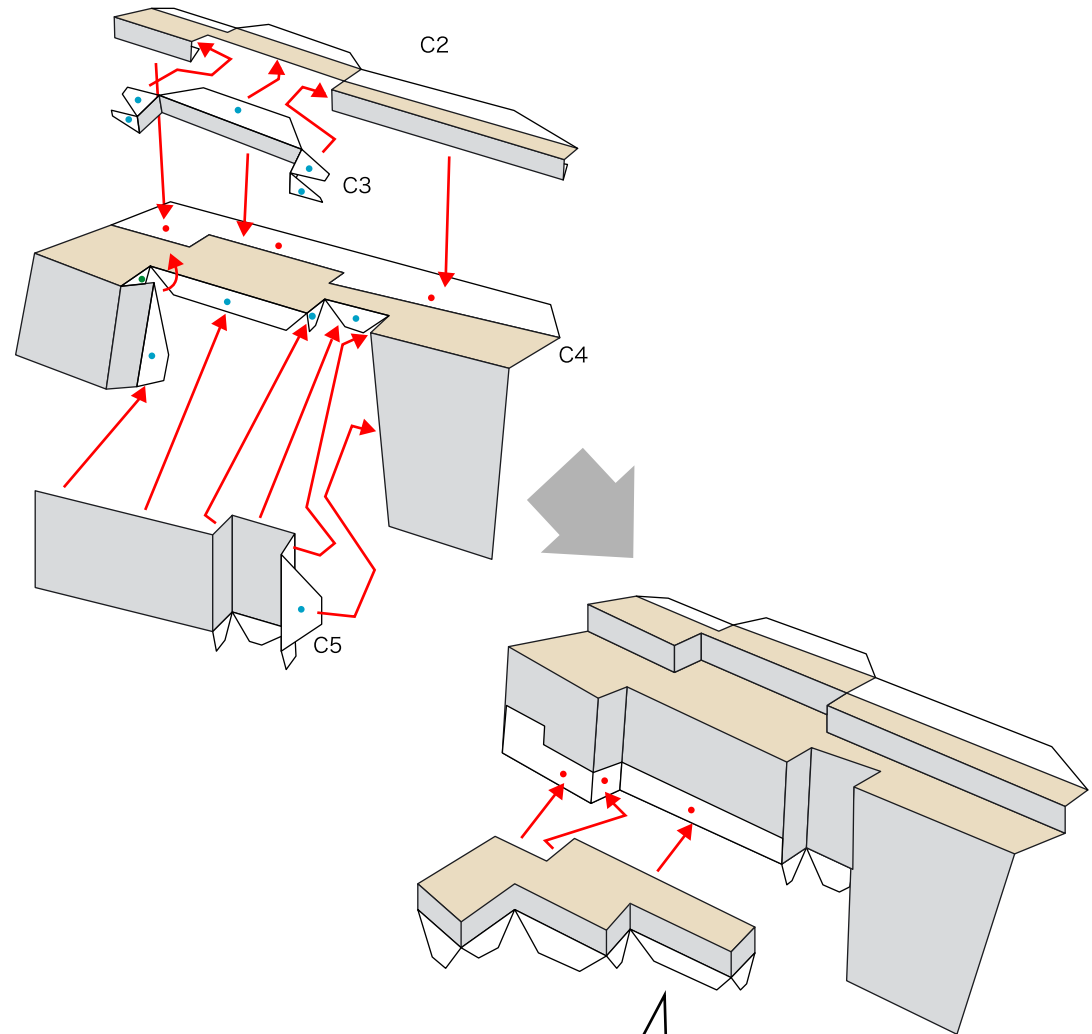
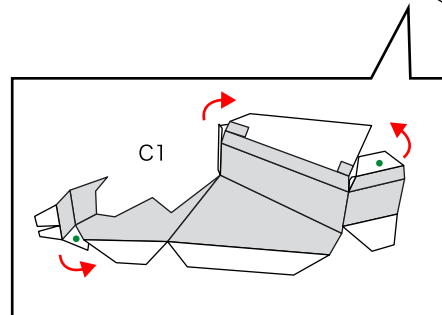
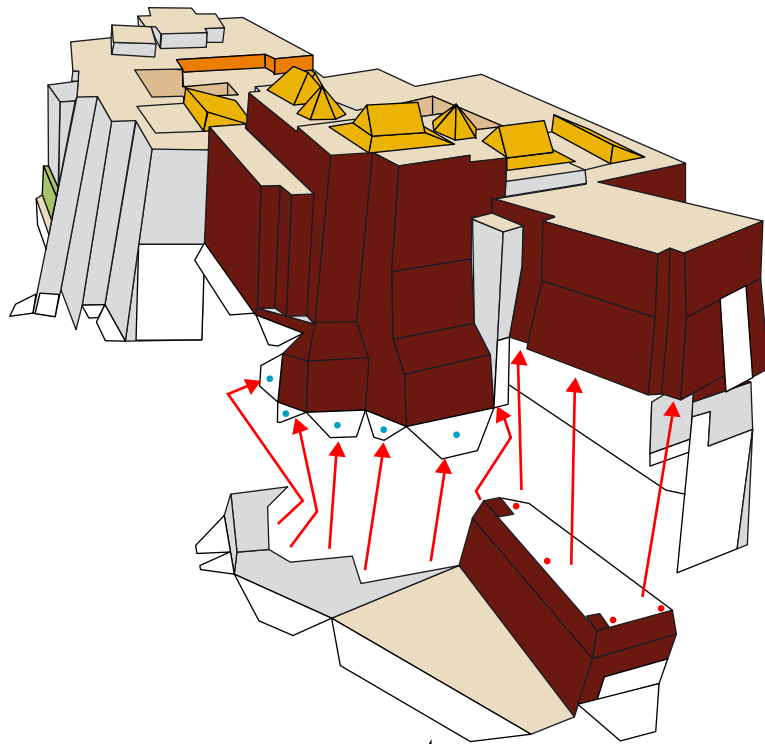

Potala Palace, China : Assembly Instructions

© Canon Inc. © T.Ichihama



C. Jie Bu Jiao / Shang Kong Xia / Xi Yuan Bao

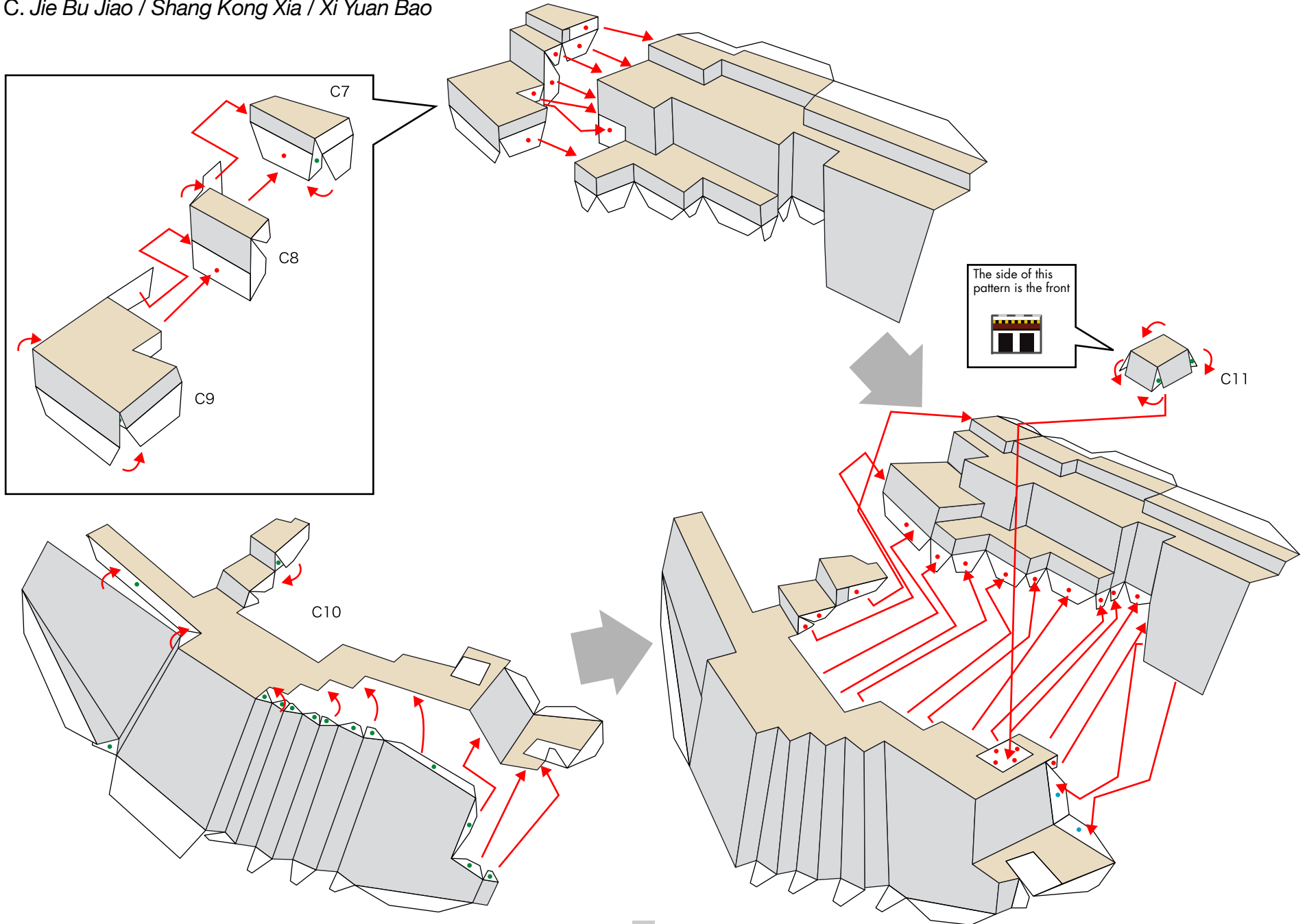

Potala Palace, China : Assembly Instructions

© Canon Inc. © T.Ichihama



C. Jie Bu Jiao / Shang Kong Xia / Xi Yuan Bao

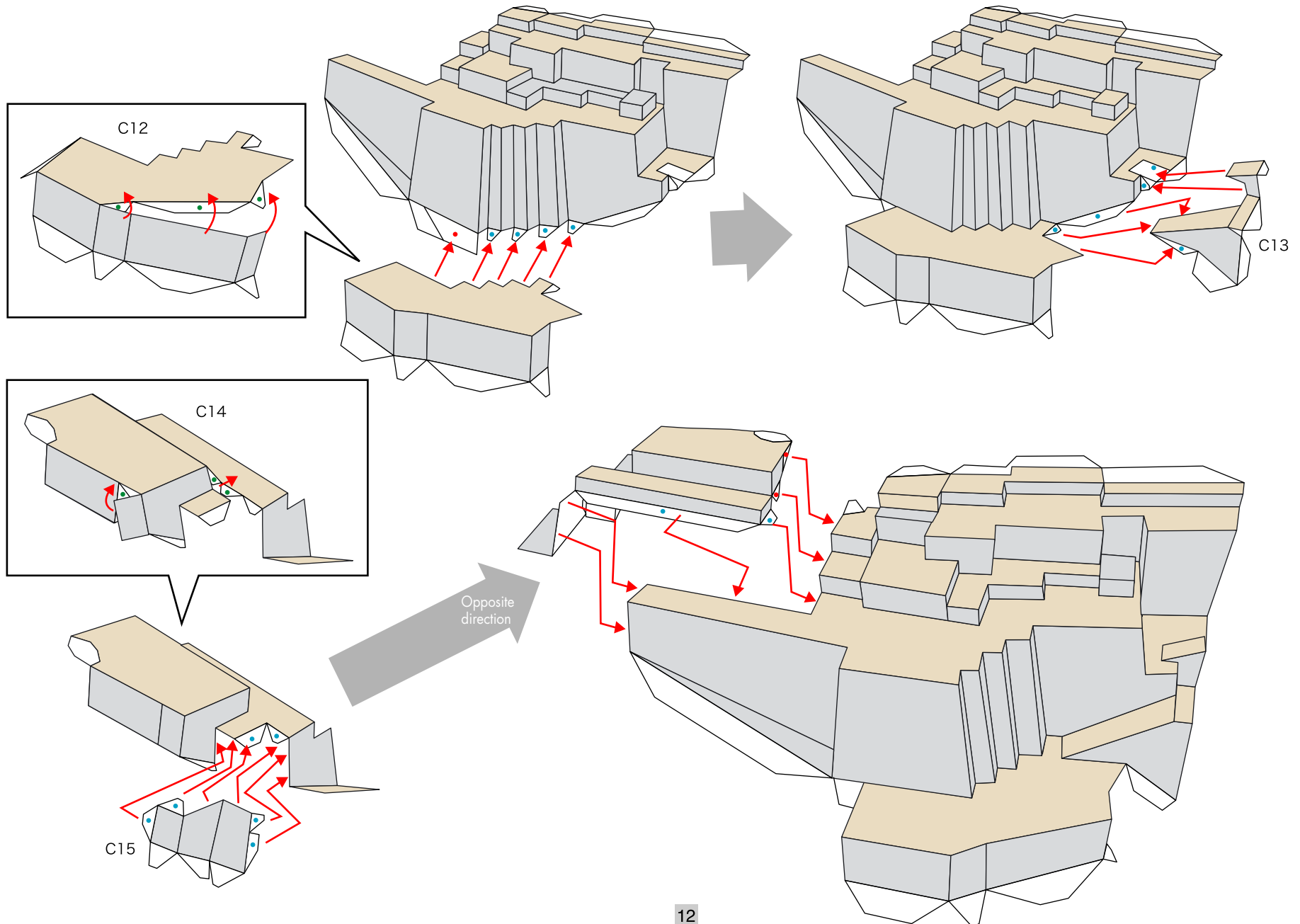

Potala Palace, China : Assembly Instructions

© Canon Inc. © T.Ichihama



C. Jie Bu Jiao / Shang Kong Xia / Xi Yuan Bao

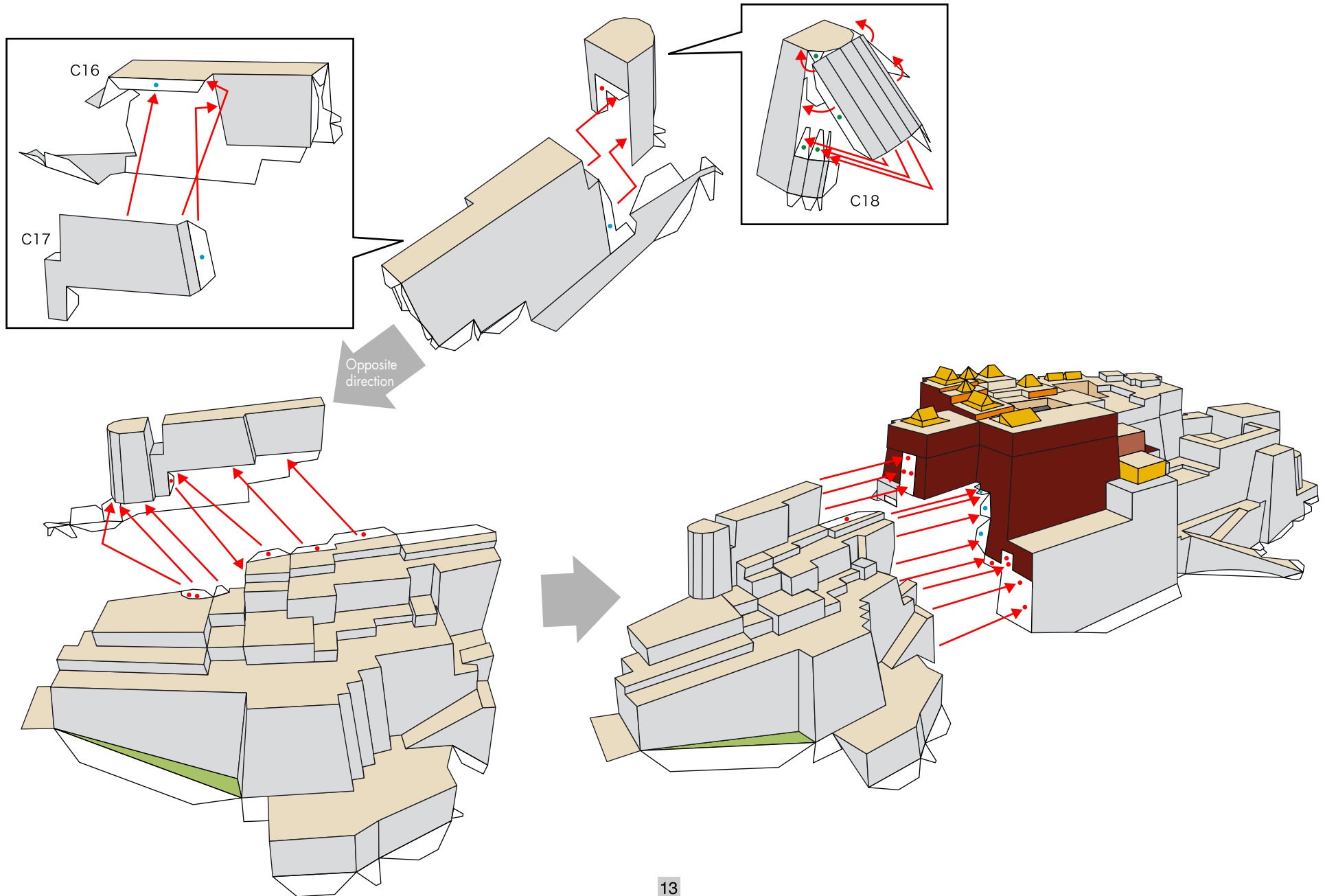

Potala Palace, China : Assembly Instructions

© Canon Inc. © T.Ichihama



C. Jie Bu Jiao / Shang Kong Xia / Xi Yuan Bao

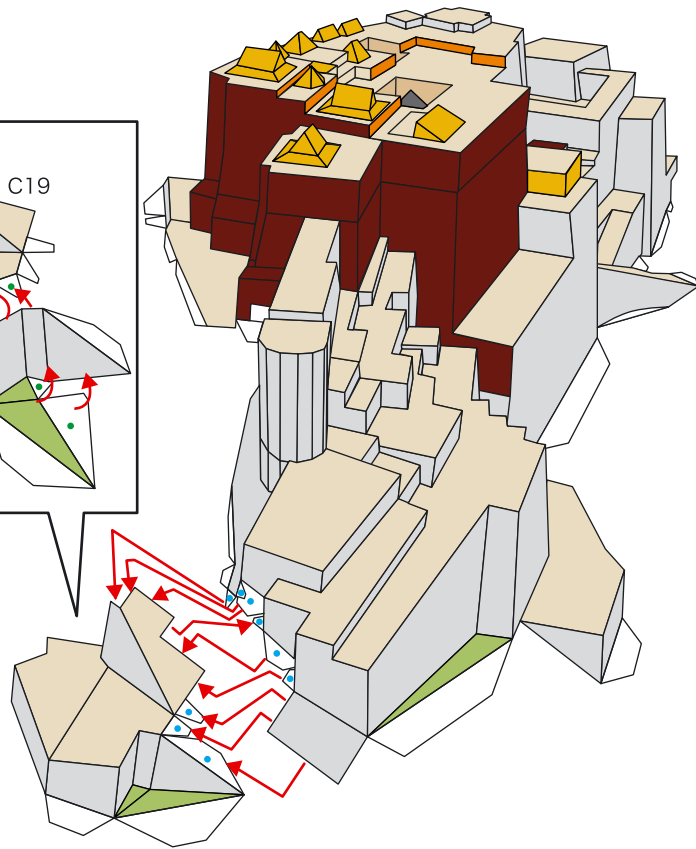
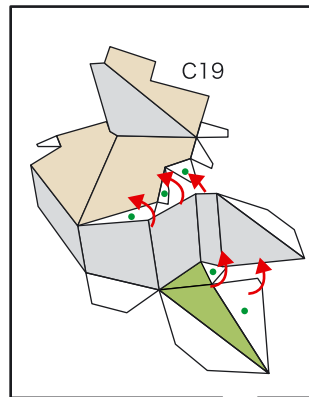

Opposite direction

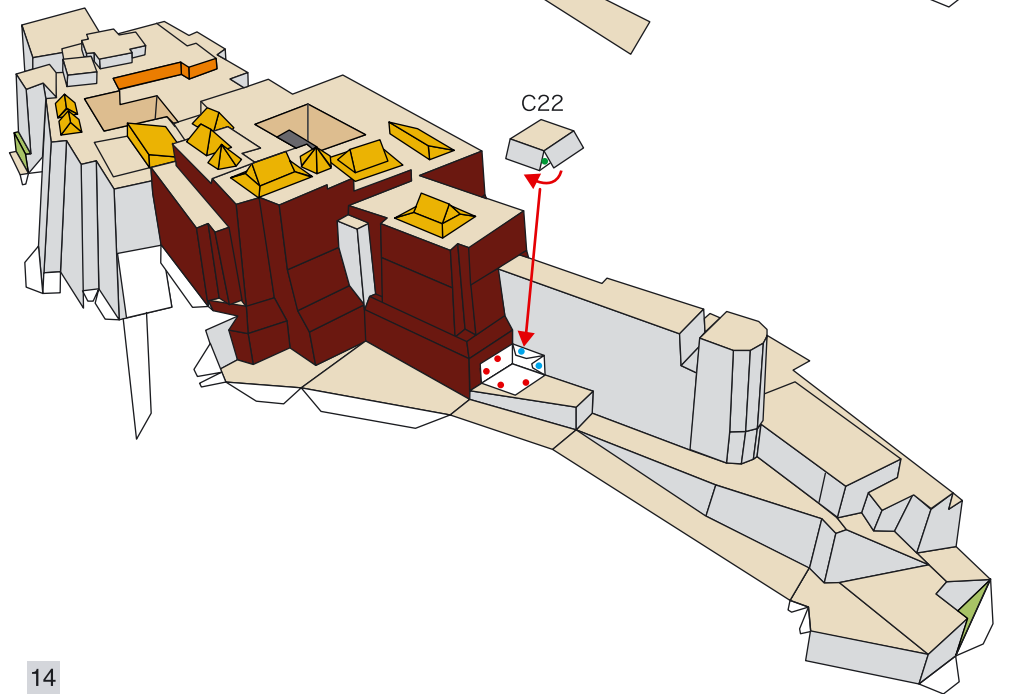
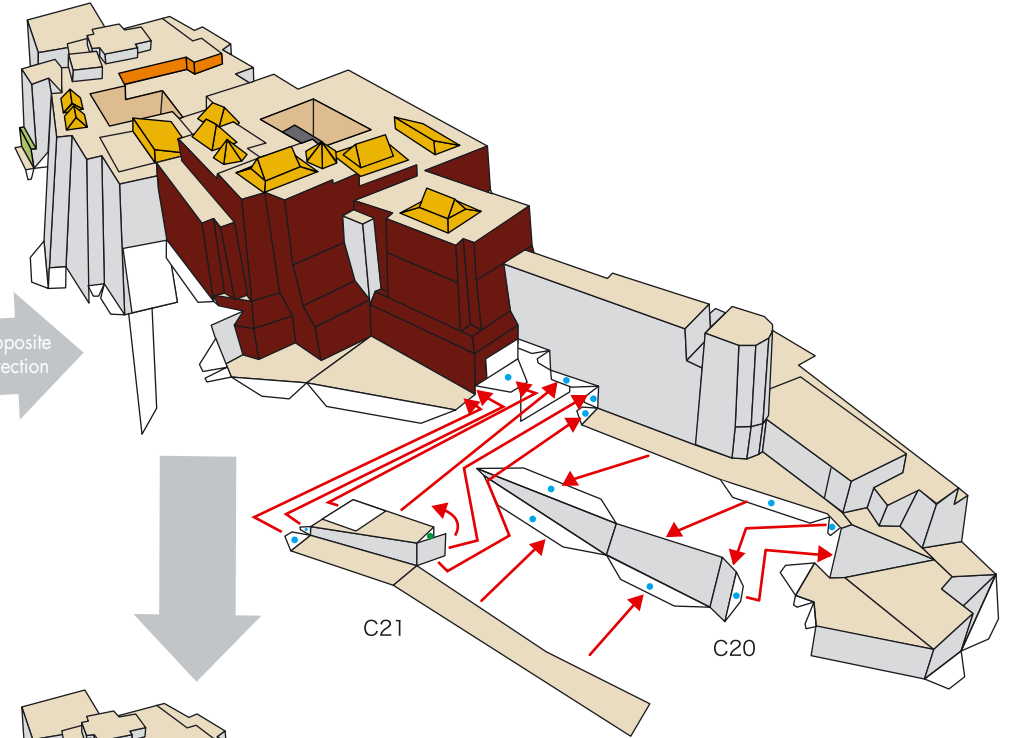

Potala Palace, China : Assembly Instructions

C. Jie Bu Jiao / Shang Kong Xia / Xi Yuan Bao

Glue to the rear side of the parts.

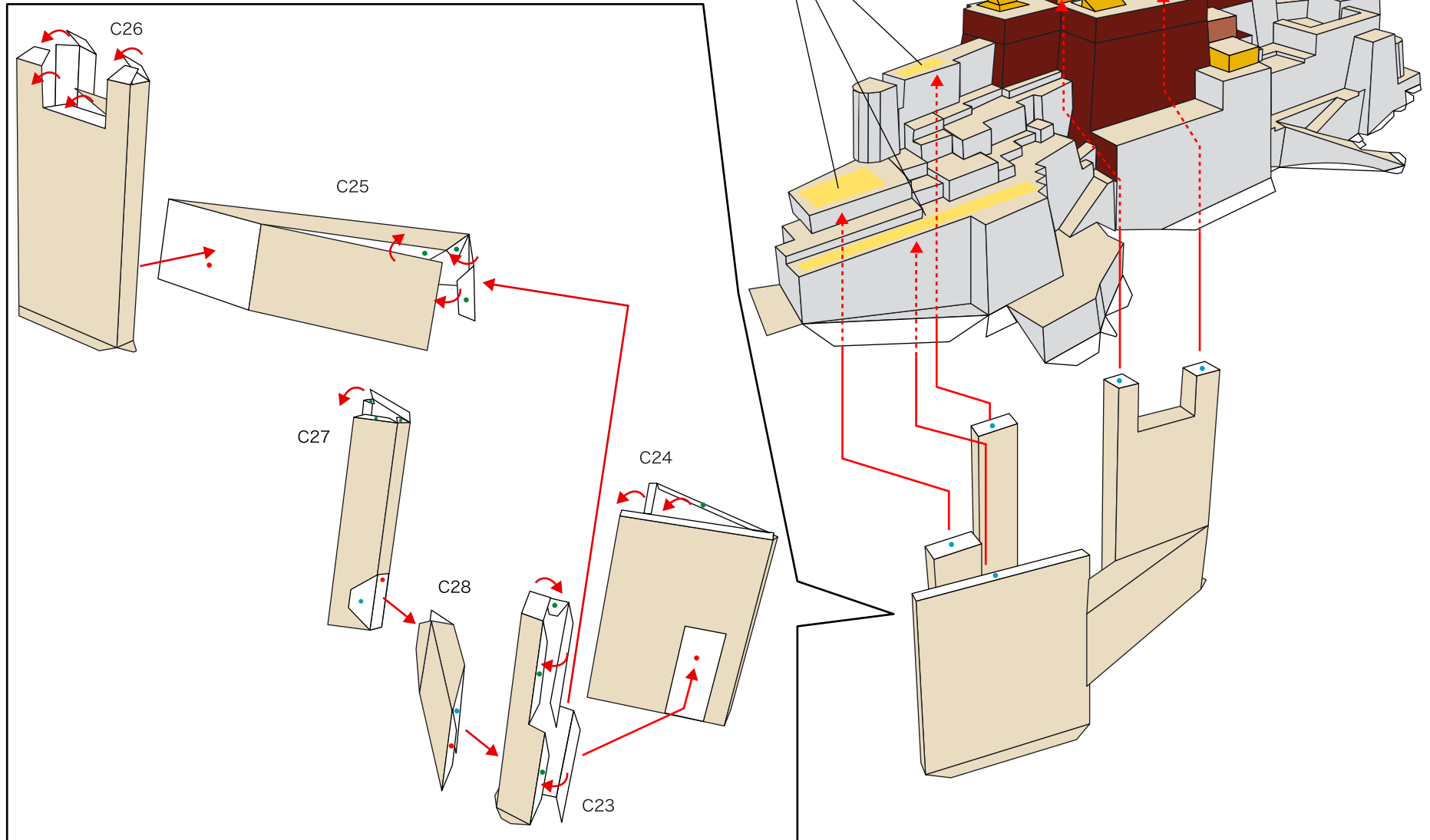

Potala Palace, China : Assembly Instructions

© Canon Inc. © T.Ichihama



D. Northern side of Marpo Ri

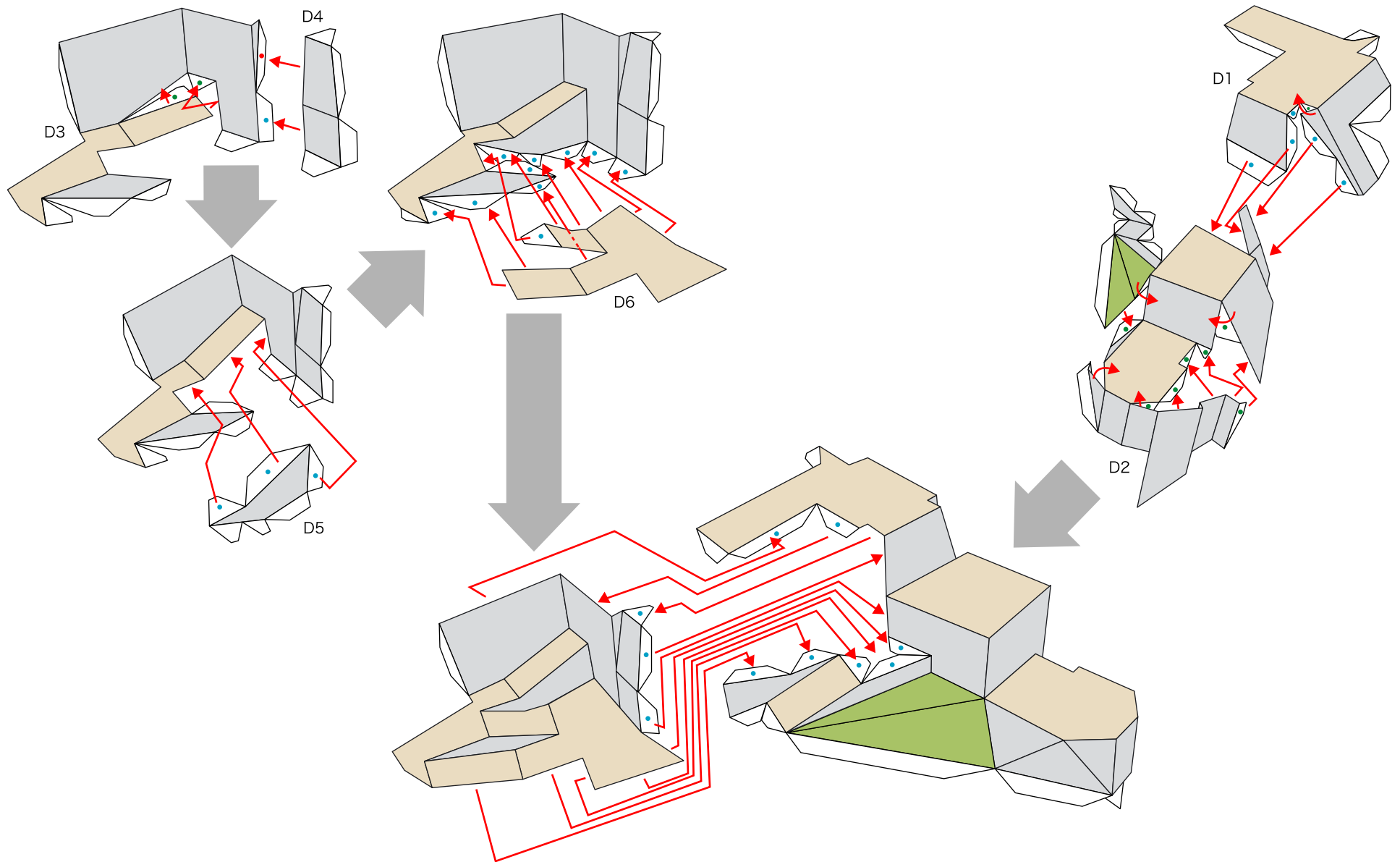

Potala Palace, China : Assembly Instructions

© Canon Inc. © T. Ichiyama



D. Northern side of Marpo Ri

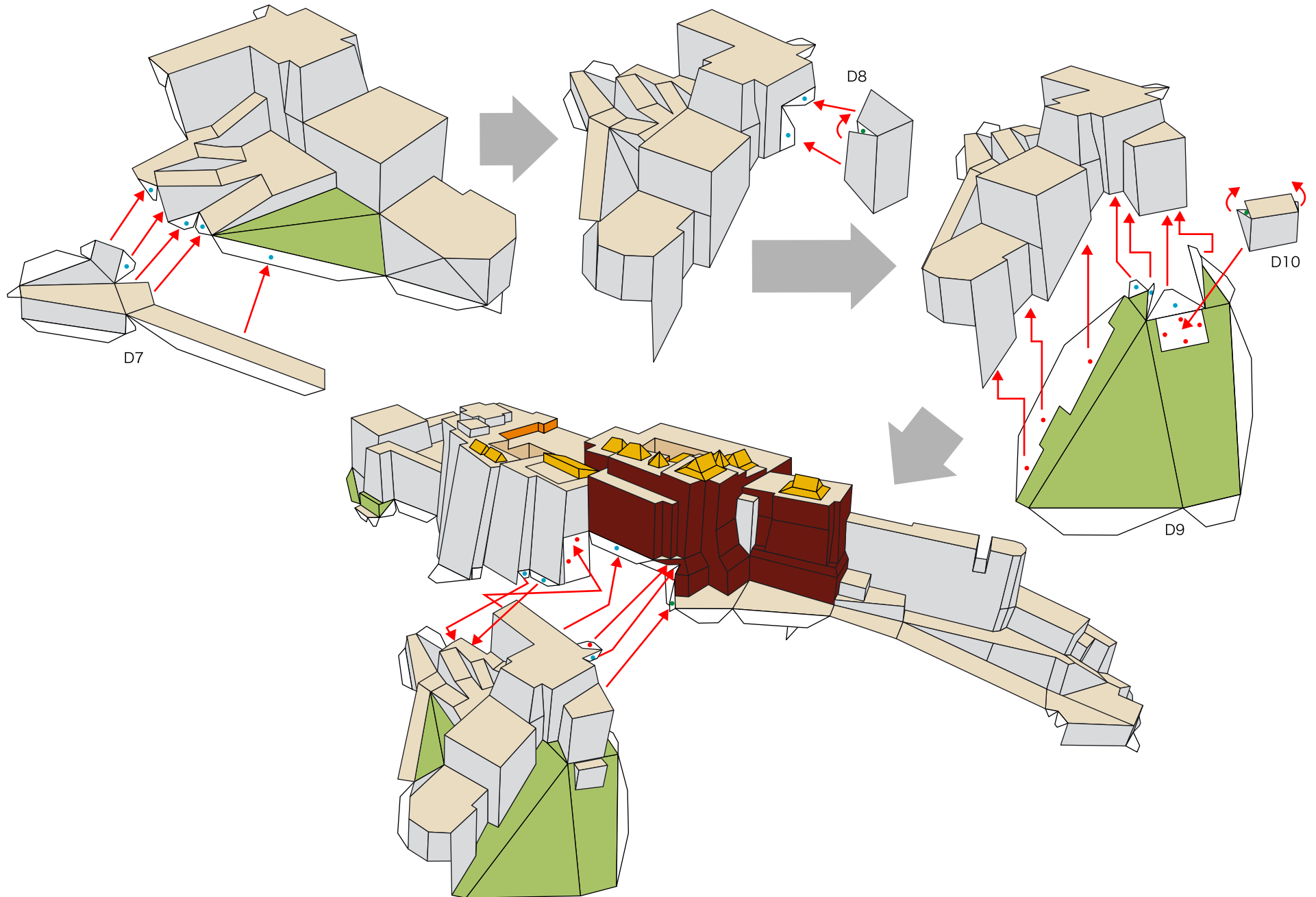

Potala Palace, China : Assembly Instructions

© Canon Inc. © T.Ichihama



D. Northern side of Marpo Ri

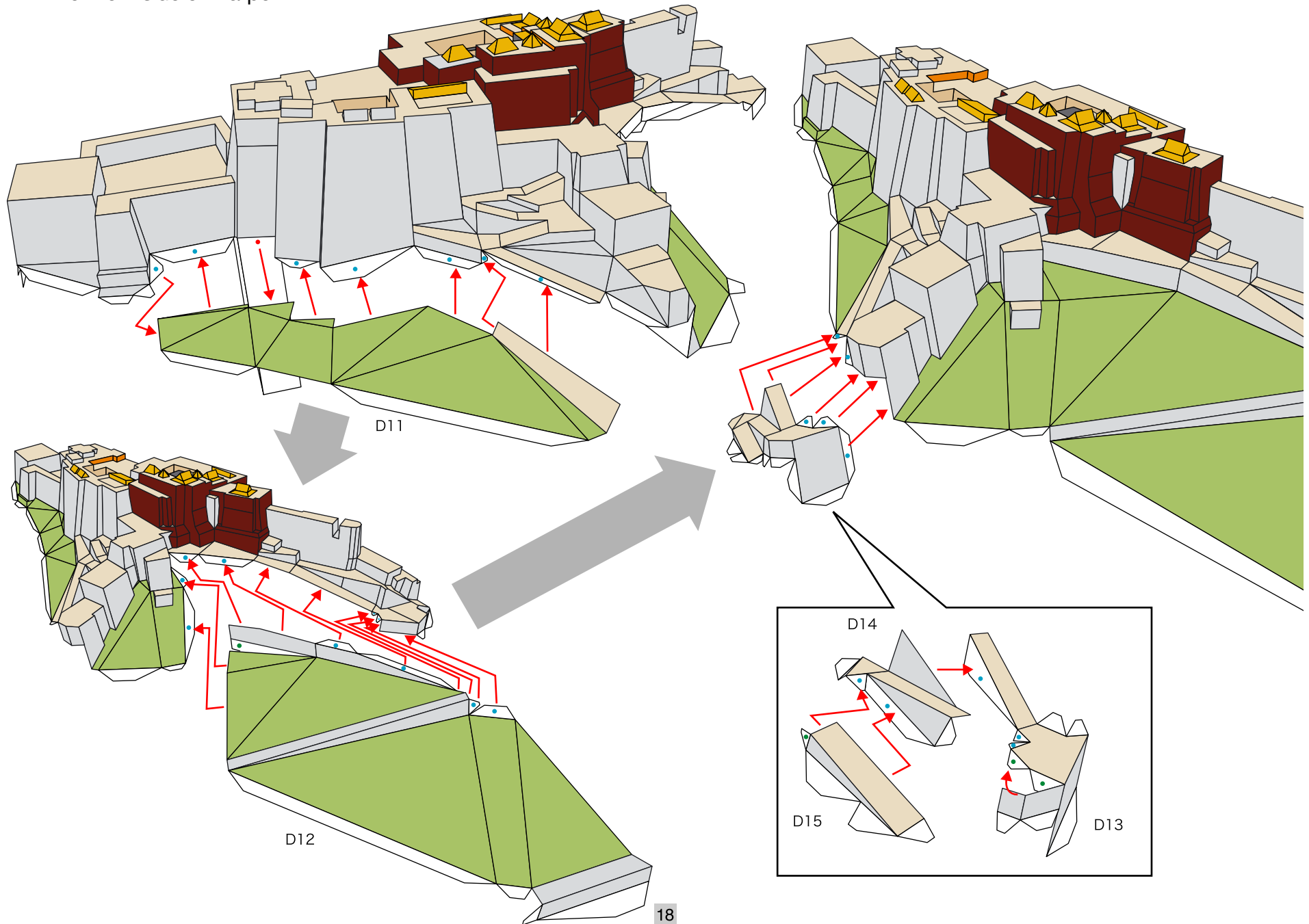

Potala Palace, China : Assembly Instructions

© Canon Inc. © T.Ichihama



D. Northern side of Marpo Ri

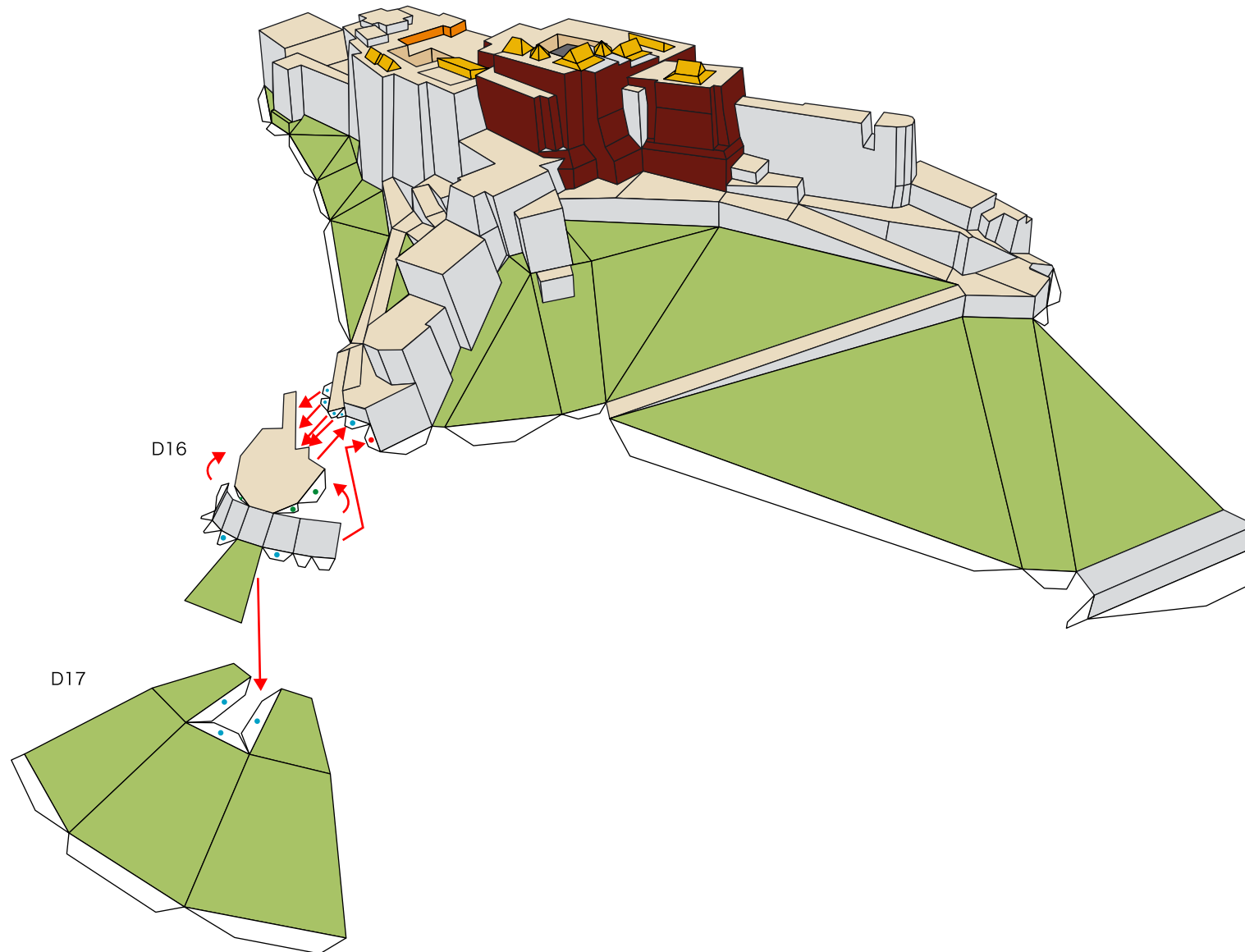

D. Northern side of Marpo Ri

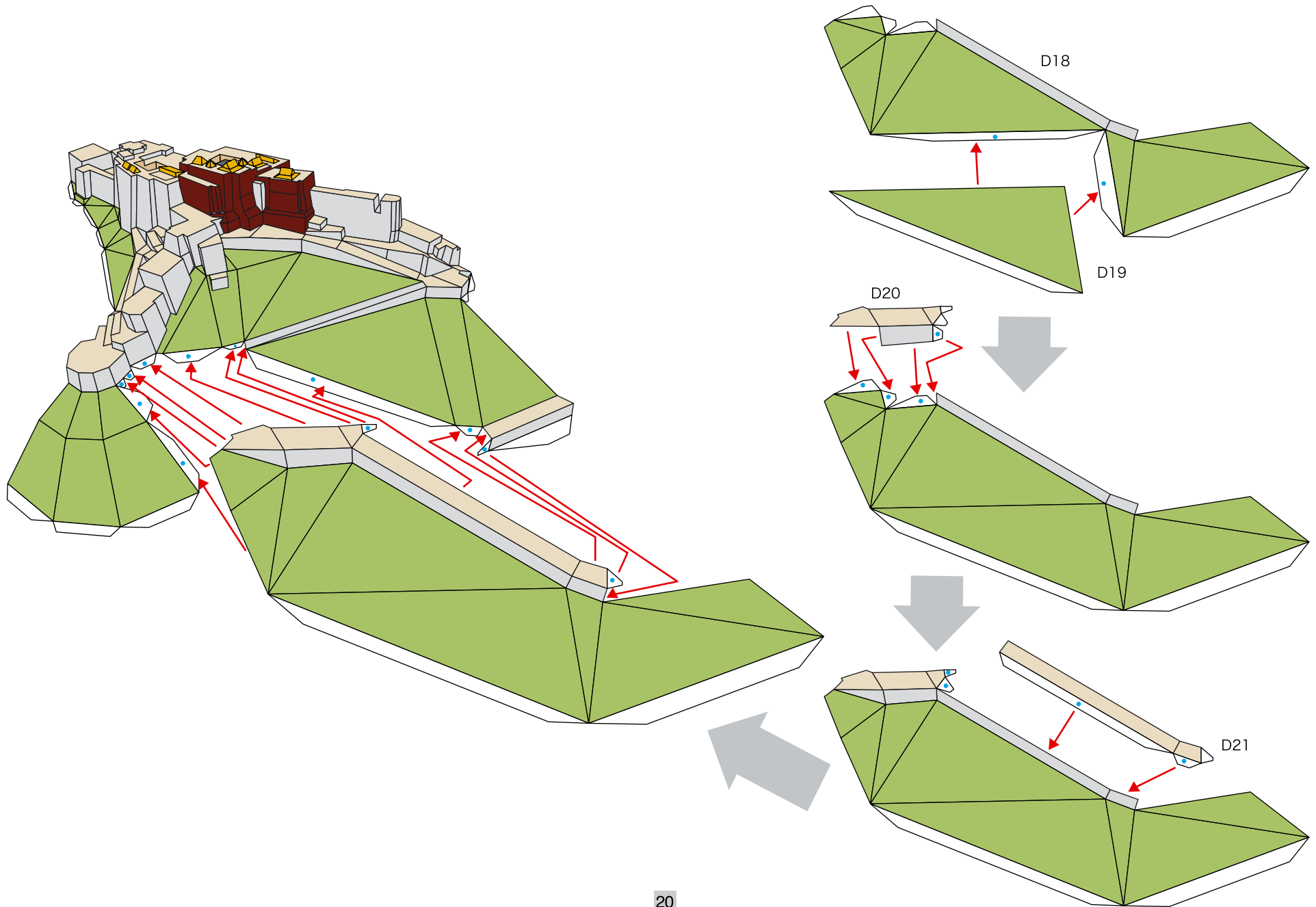

Potala Palace, China : Assembly Instructions

E. Eastern side of Marpo Ri

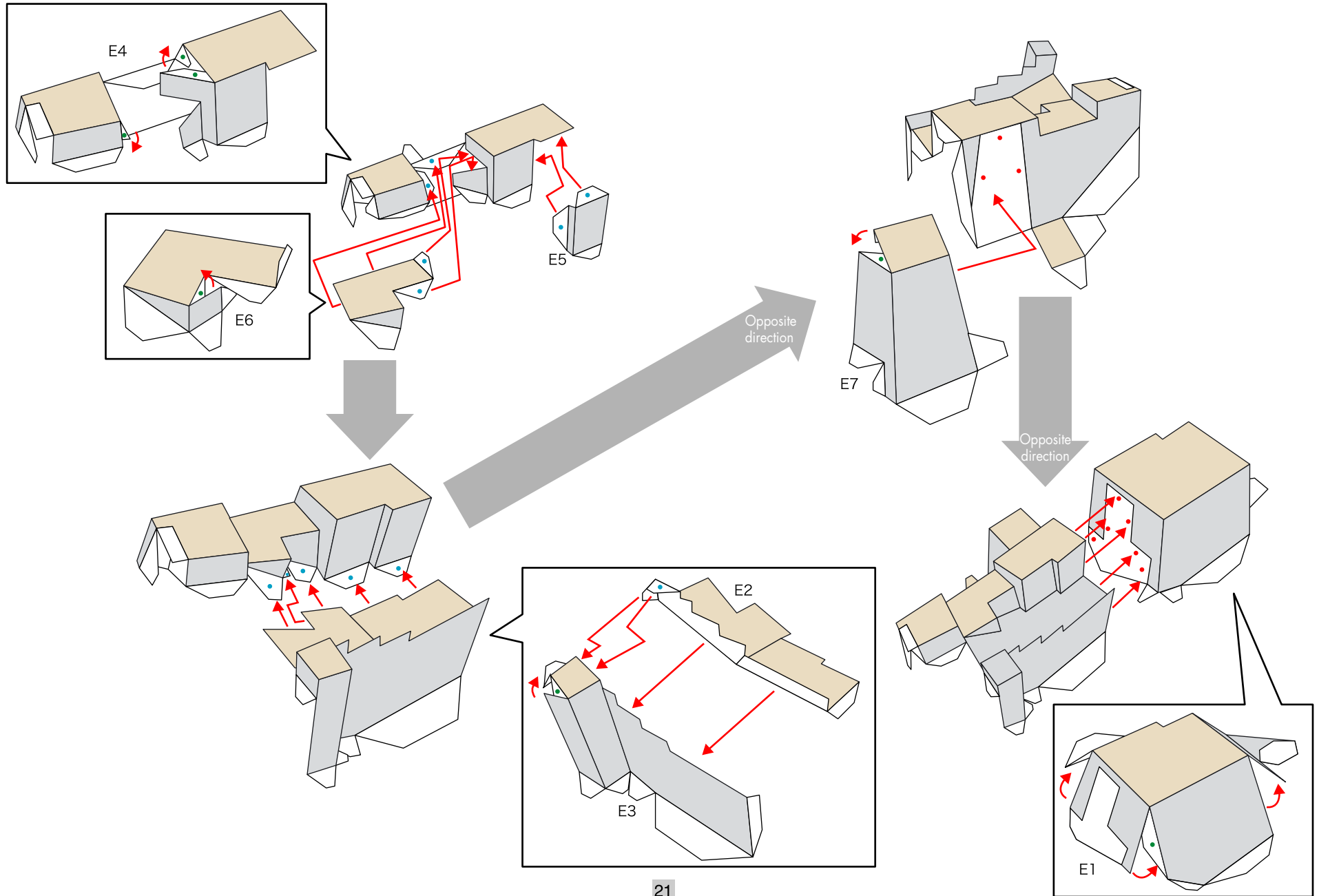

Potala Palace, China : Assembly Instructions

© Canon Inc. © T.Ichihama



E. Eastern side of Marpo Ri

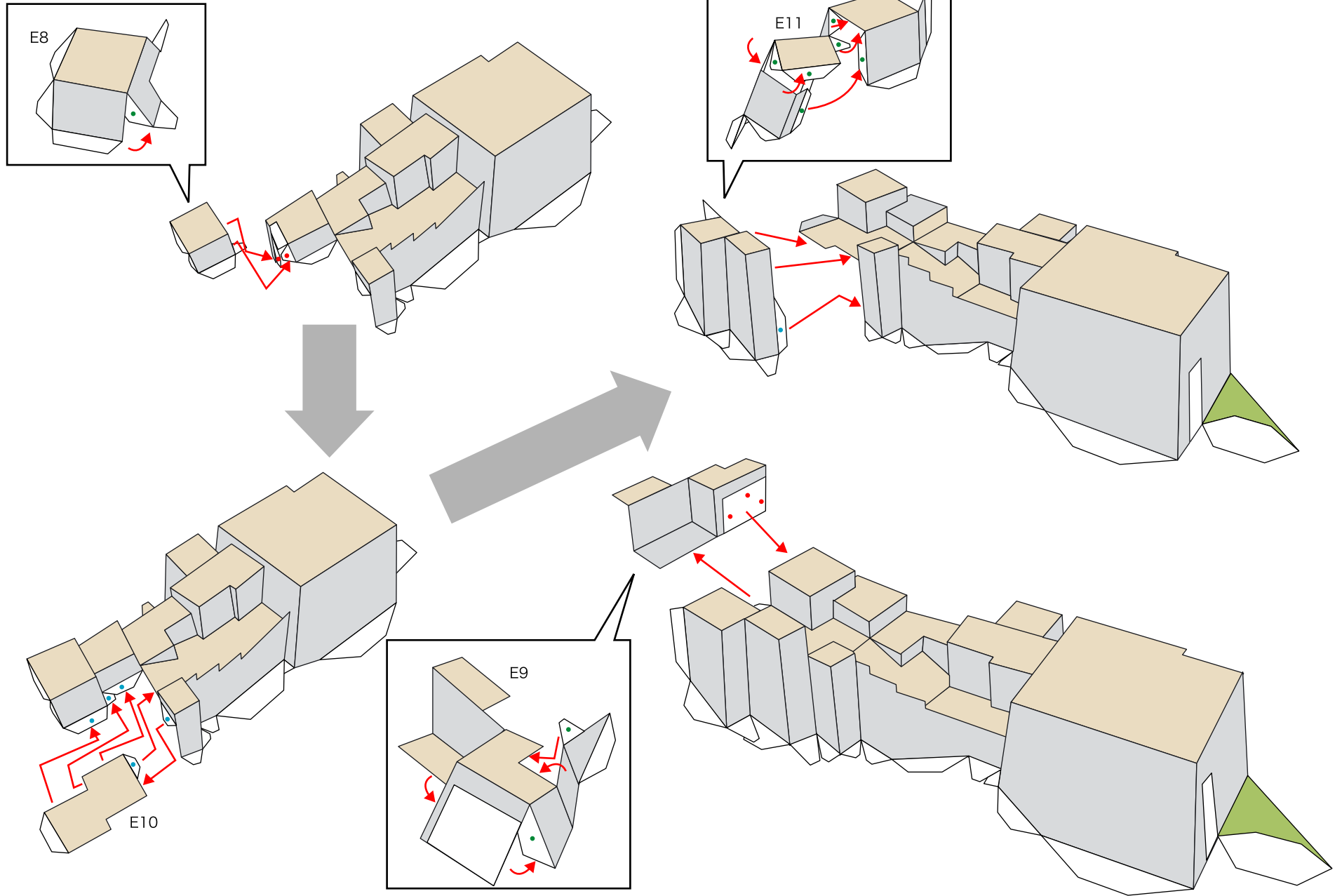

Potala Palace, China : Assembly Instructions

E. Eastern side of Marpo Ri

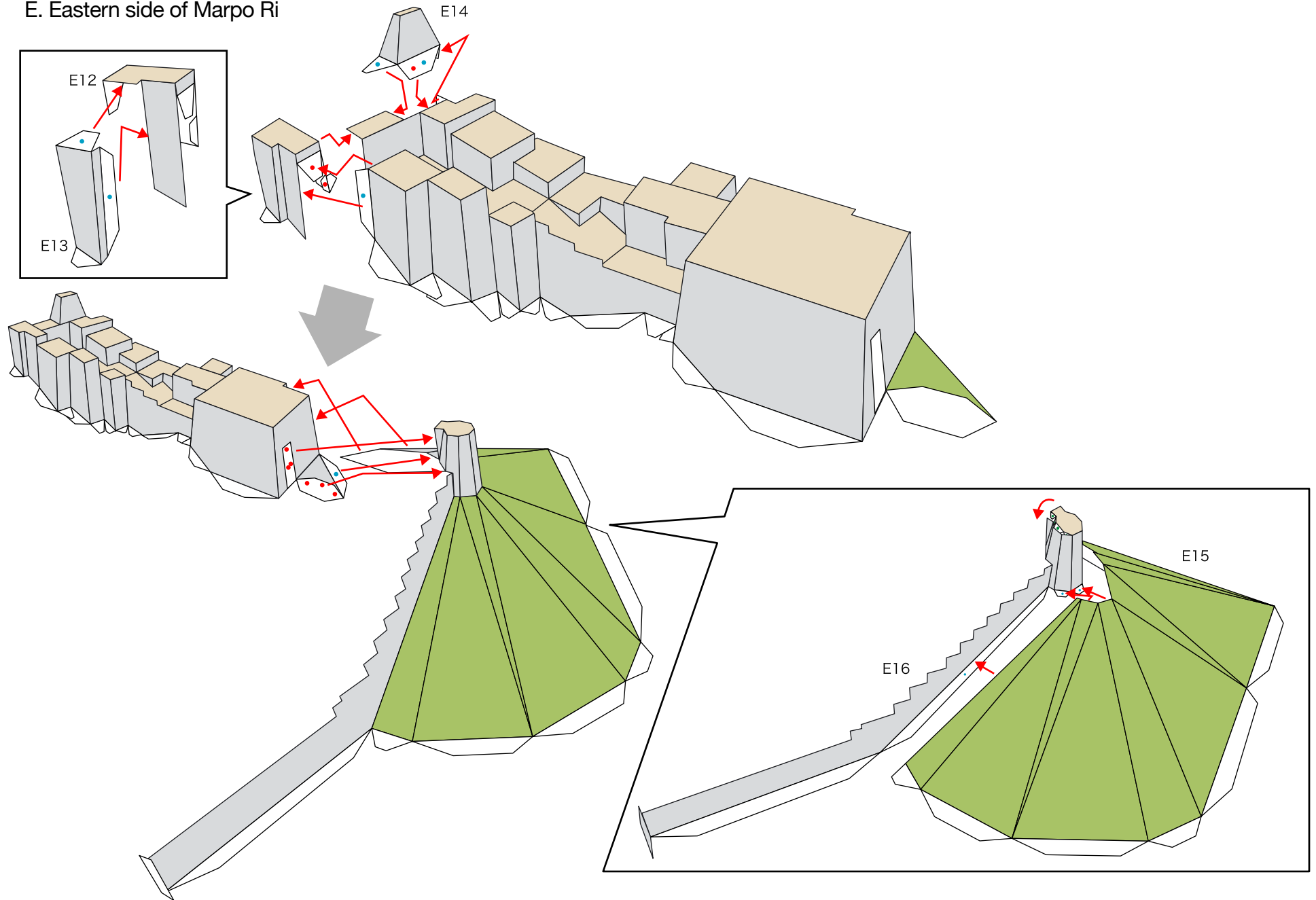

Potala Palace, China : Assembly Instructions

© Canon Inc. © T.Ichihama



E. Eastern side of Marpo Ri

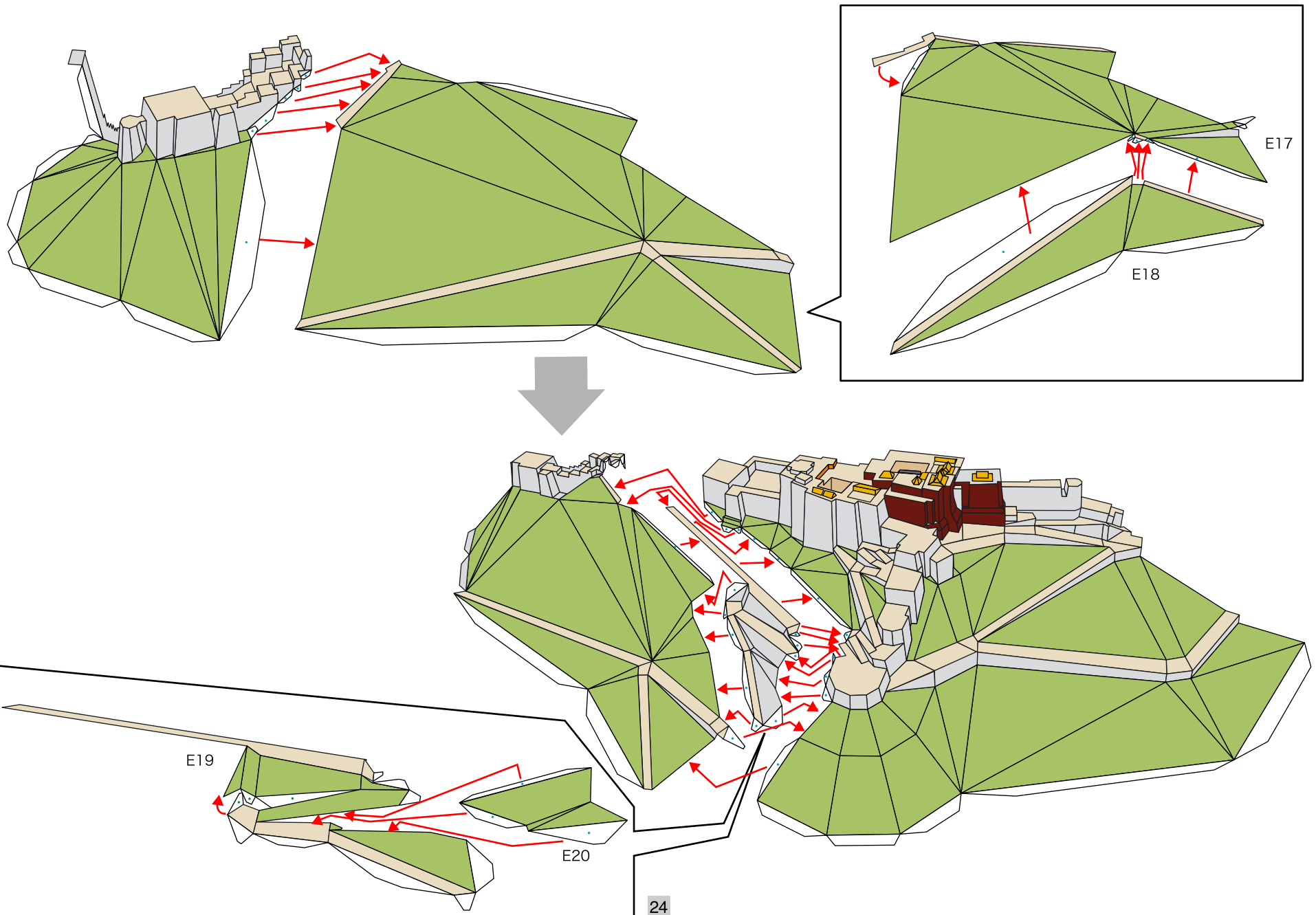

F. Southern side of Marpo Ri / Front steps

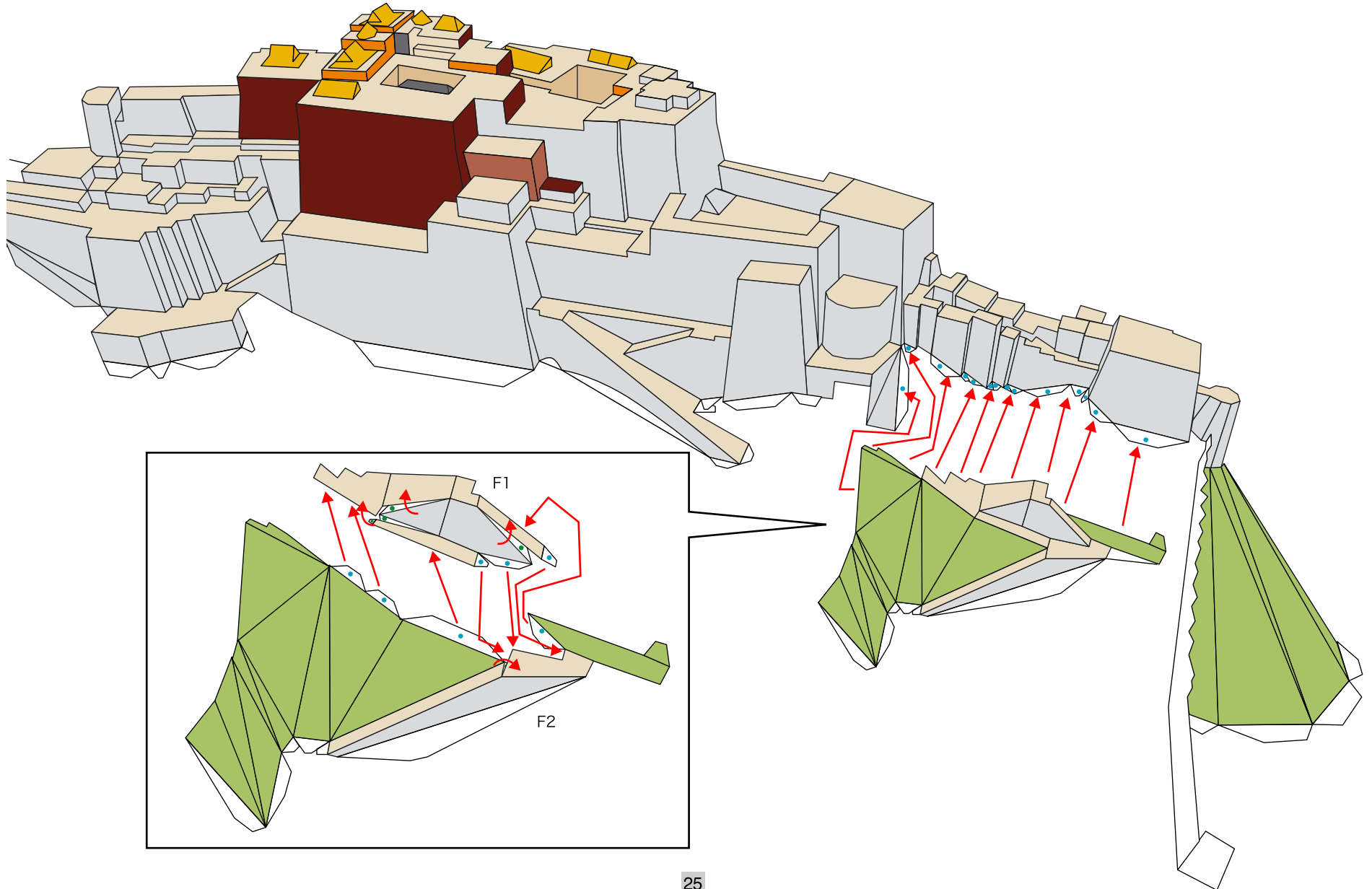

F. Southern side of Marpo Ri / Front steps

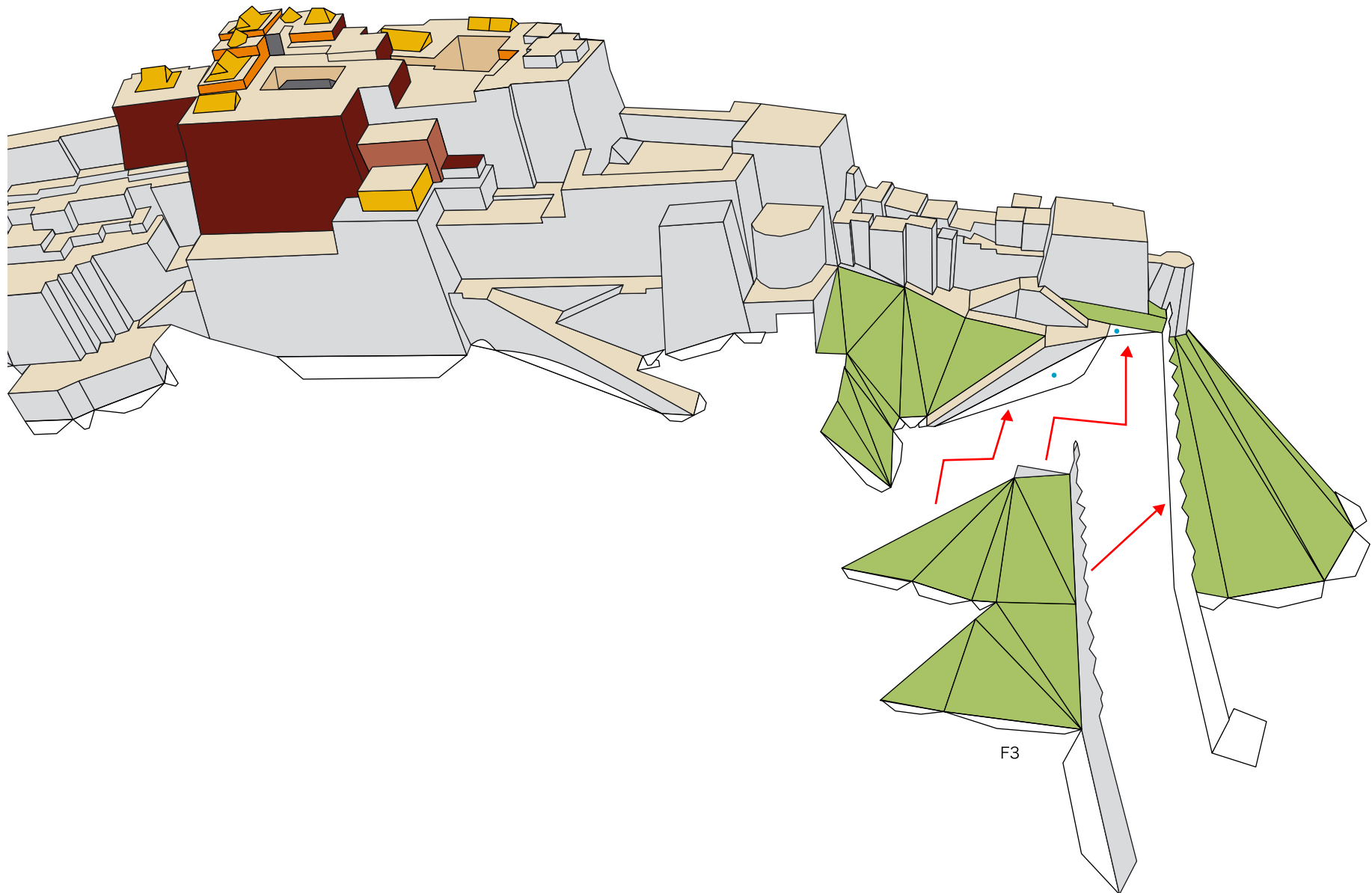

Potala Palace, China : Assembly Instructions

© Canon Inc. © T.Ichihama



F. Southern side of Marpo Ri
/ Front steps

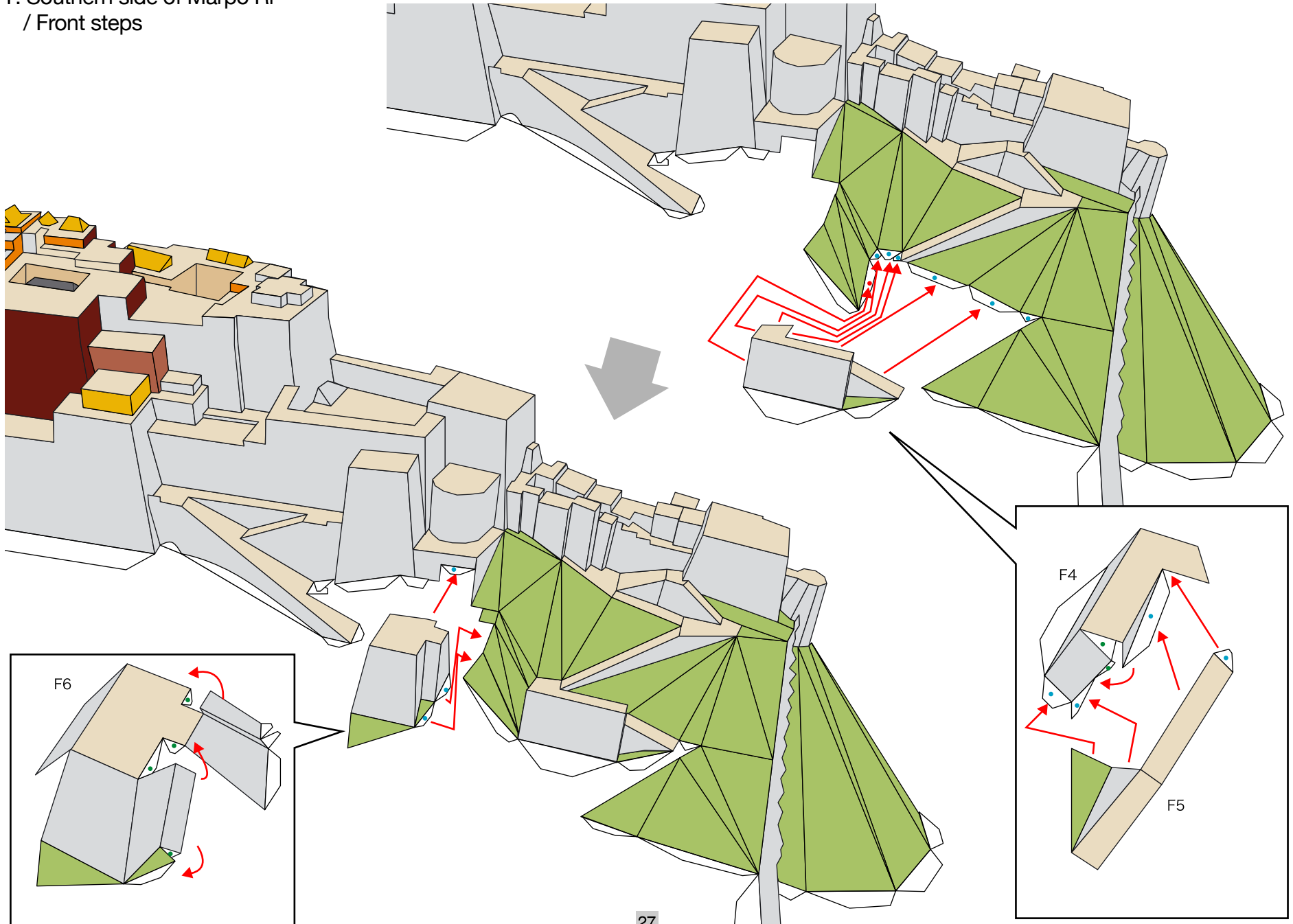

Potala Palace, China : Assembly Instructions

© Canon Inc. © T.Ichihama



F. Southern side of Marpo Ri / Front steps

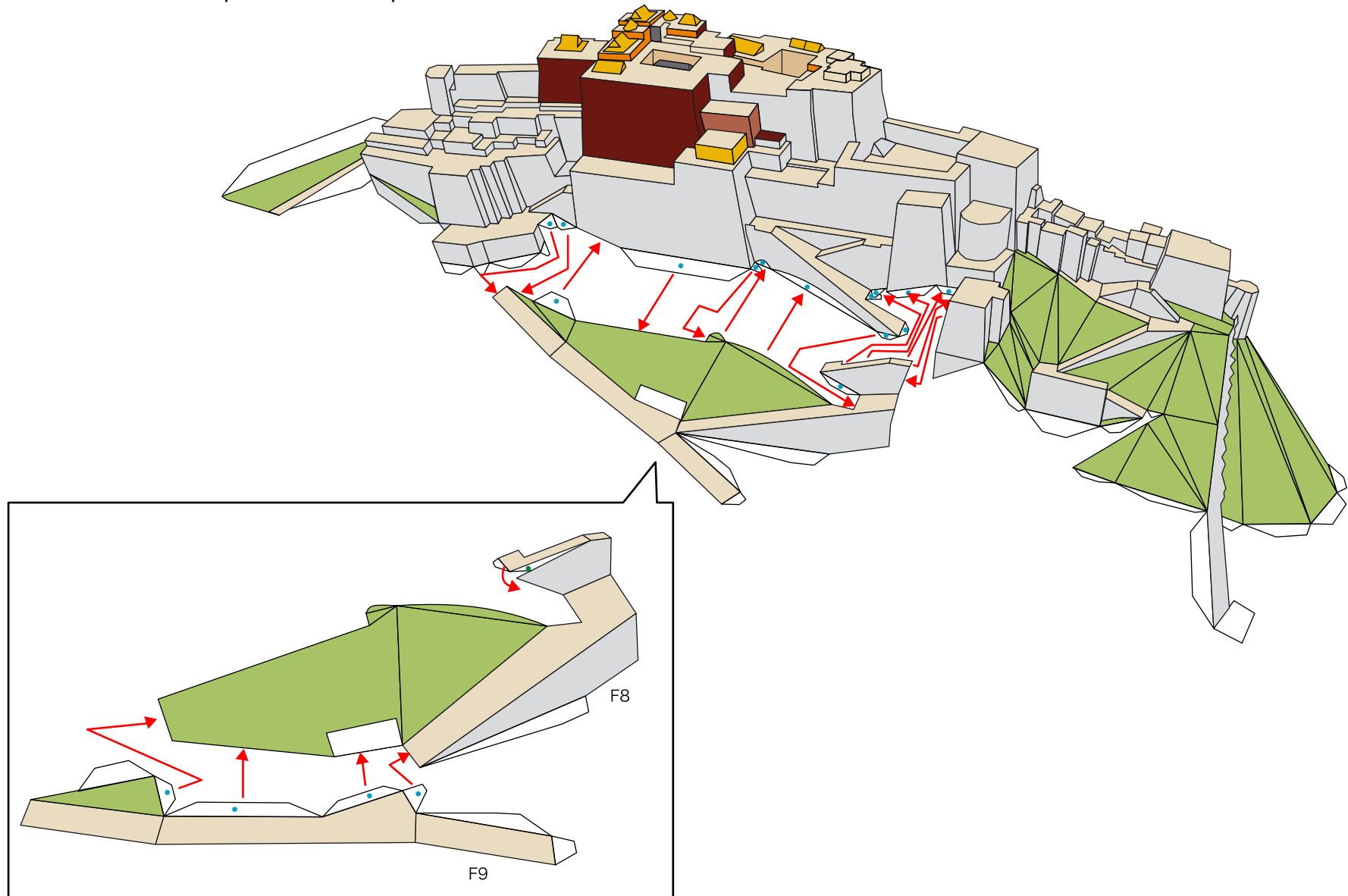

F. Southern side of Marpo Ri / Front steps

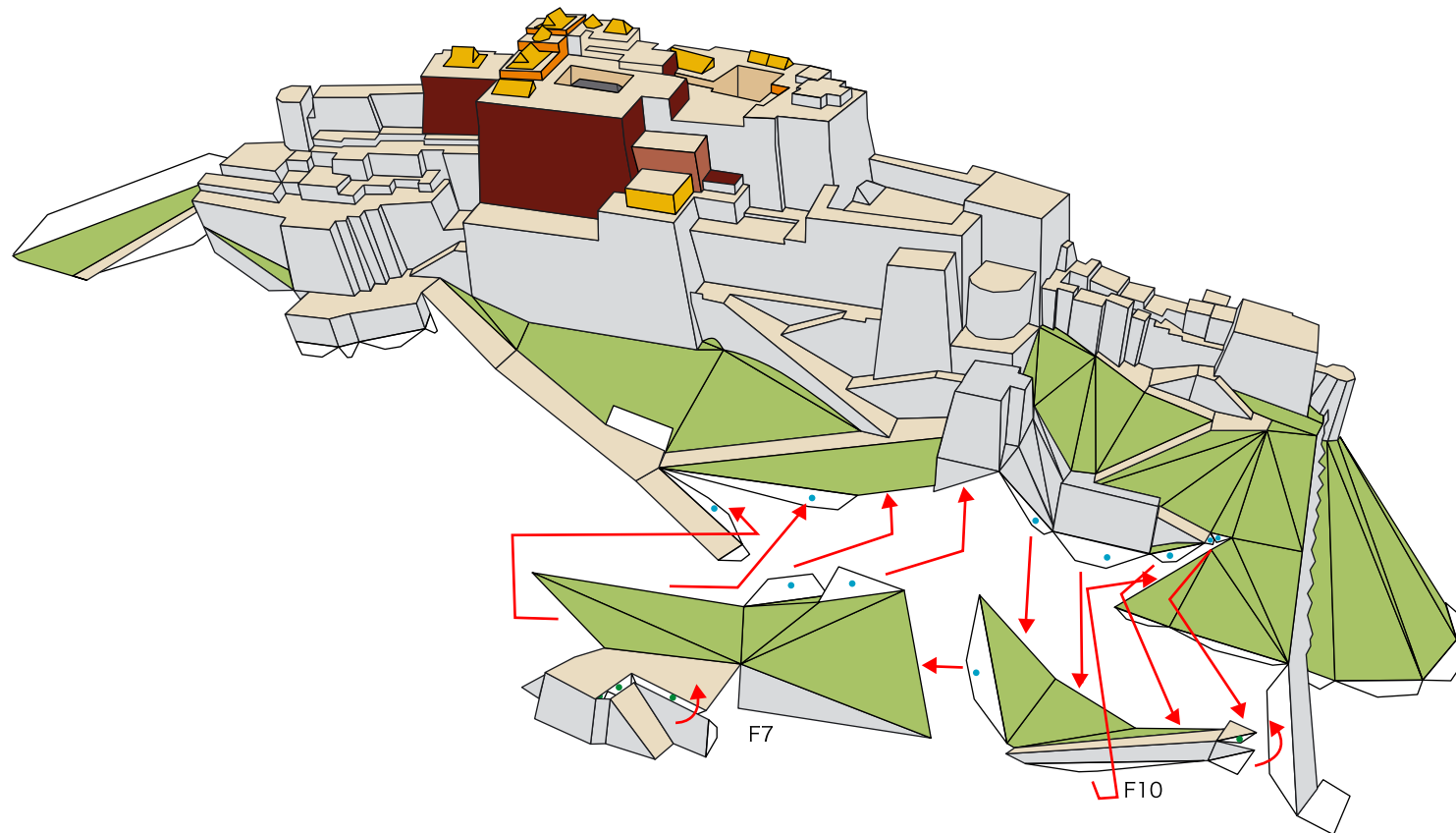

F. Southern side of Marpo Ri / Front steps

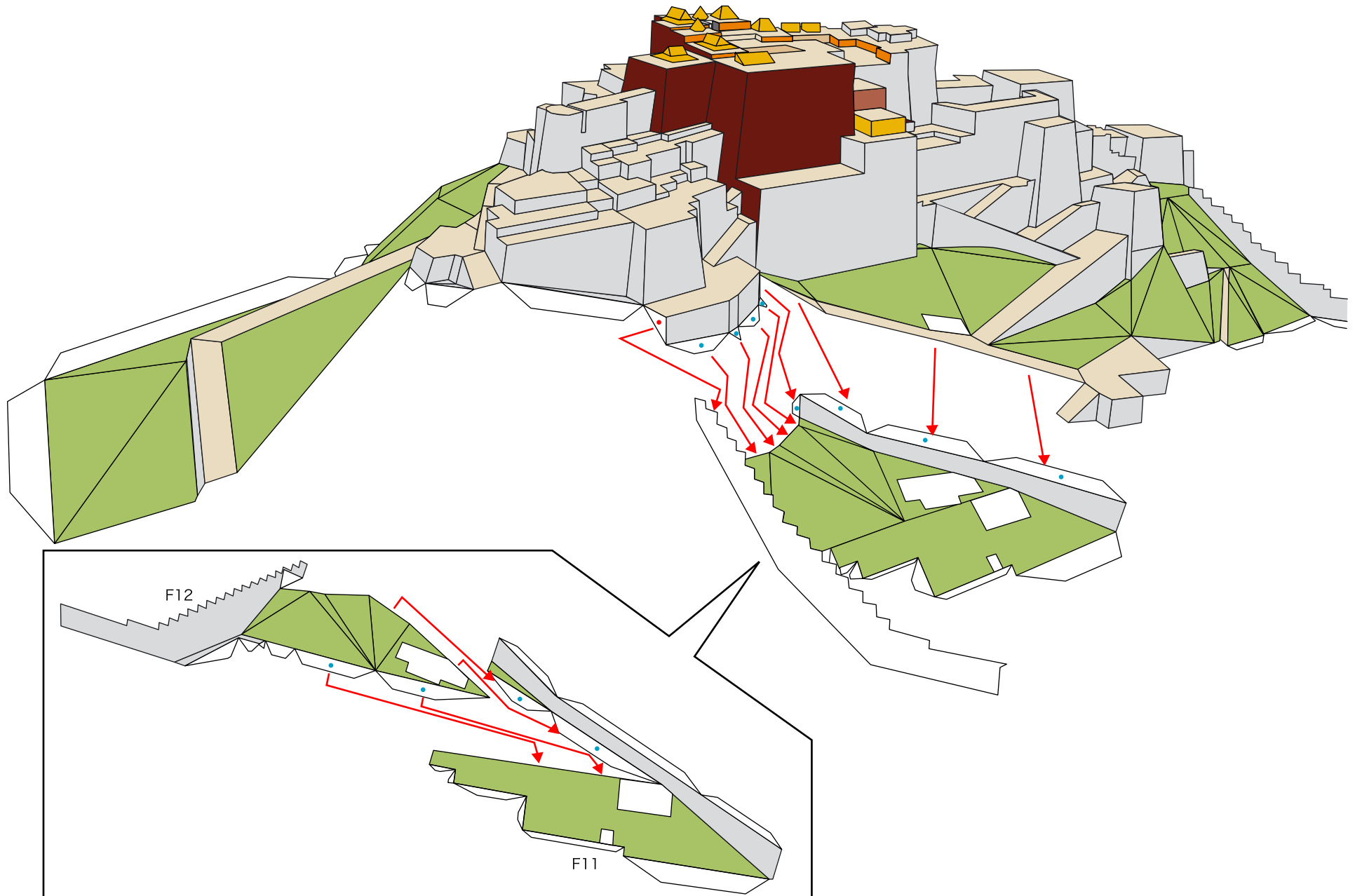

Potala Palace, China : Assembly Instructions

© Canon Inc. © T.Ichiyama



F. Southern side of Marpo Ri / Front steps

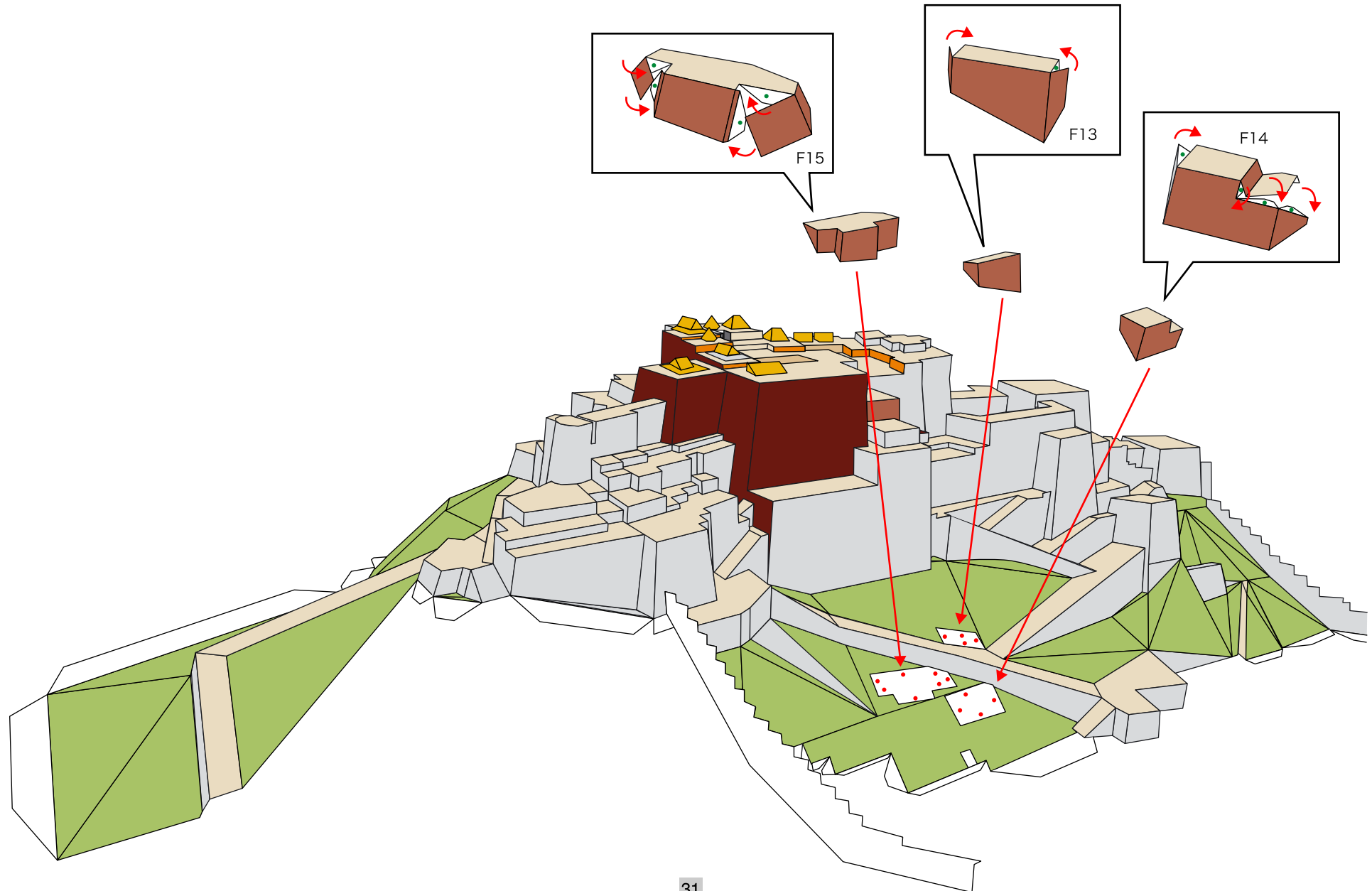

G. Southern side of Marpo Ri / Front steps

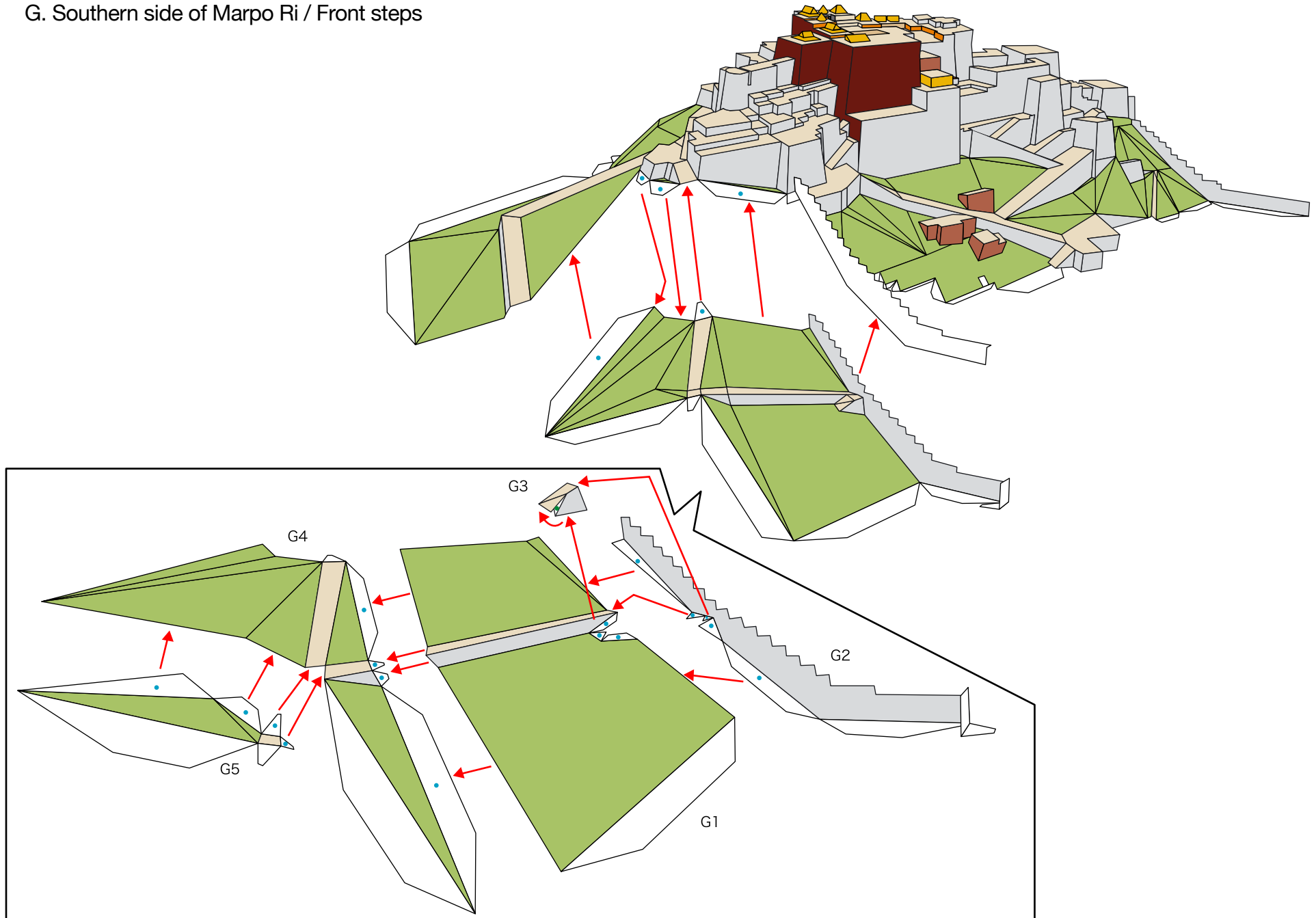

G. Southern side of Marpo Ri / Front steps

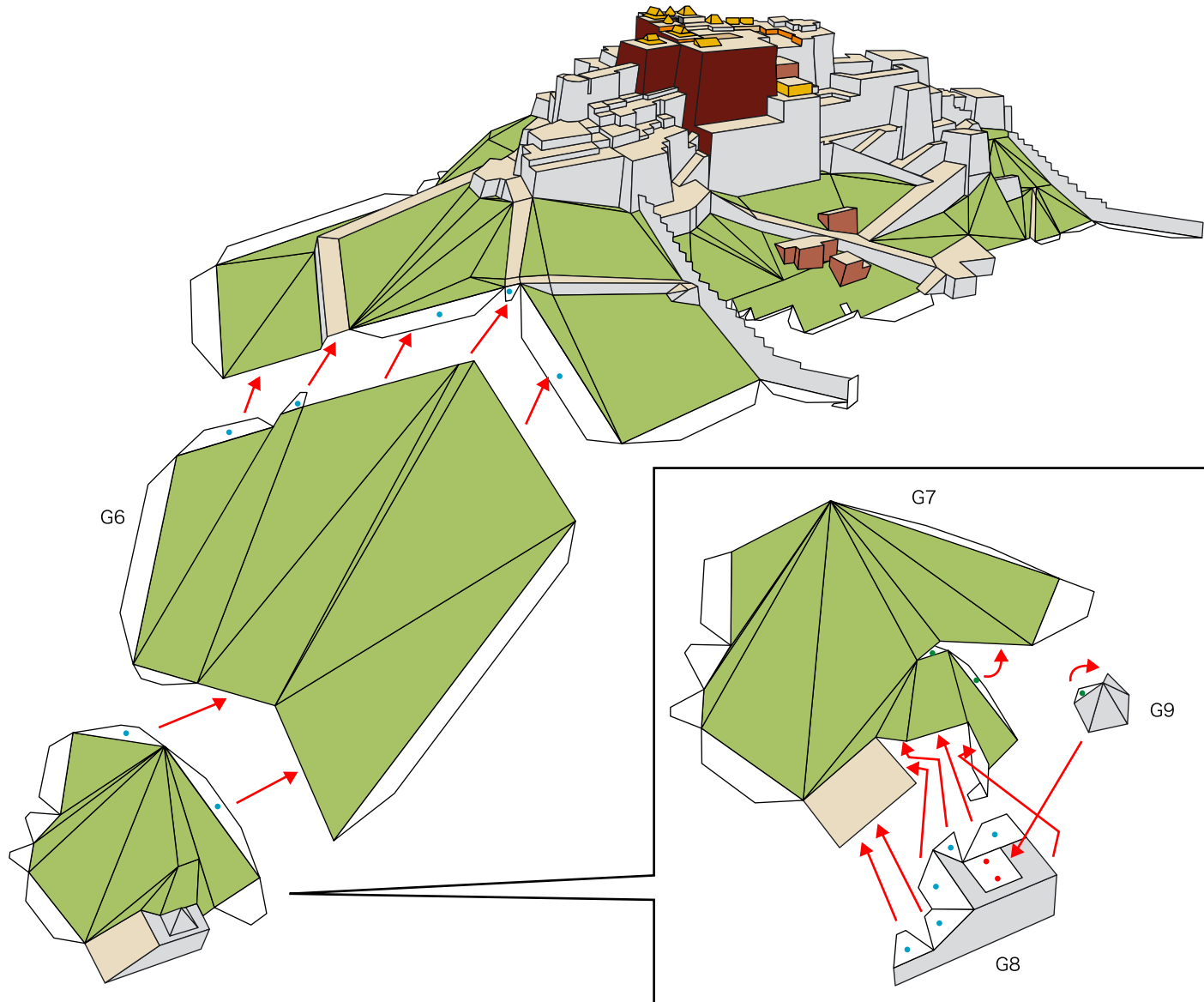

H. Government office district

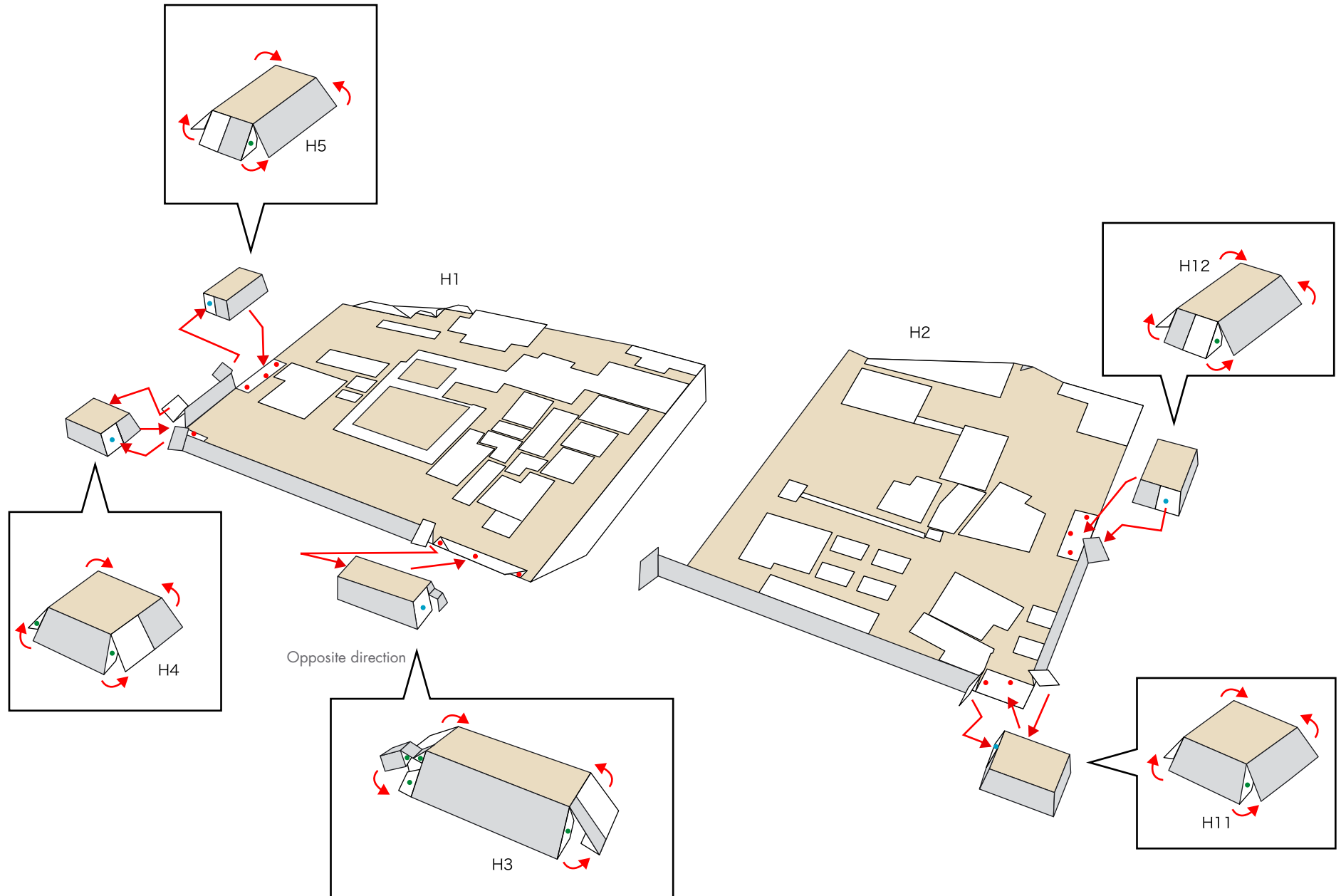

Potala Palace, China : Assembly Instructions

© Canon Inc. © T.Ichiyama



H. Government office district

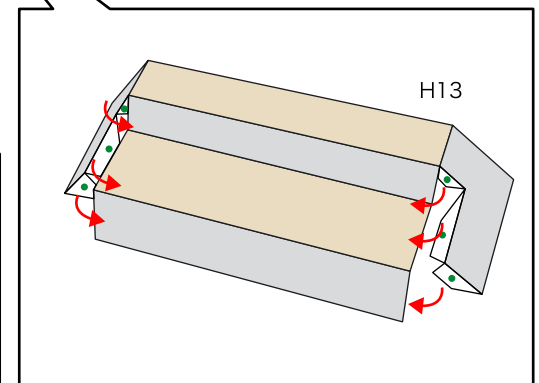
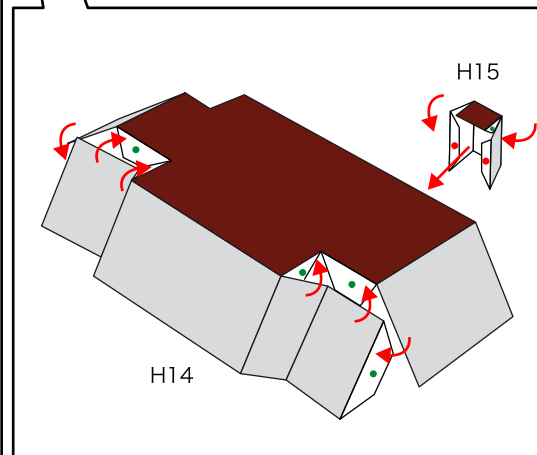
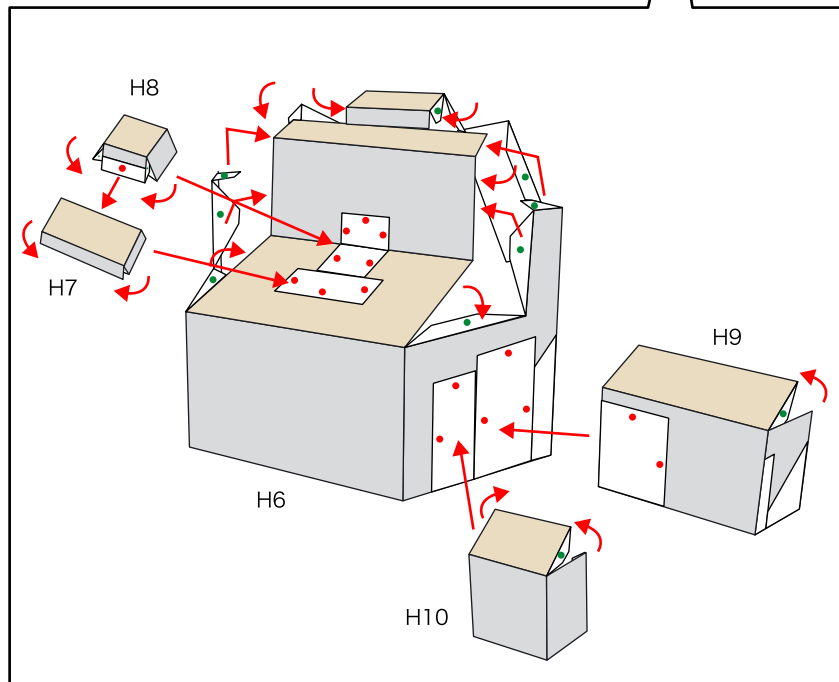
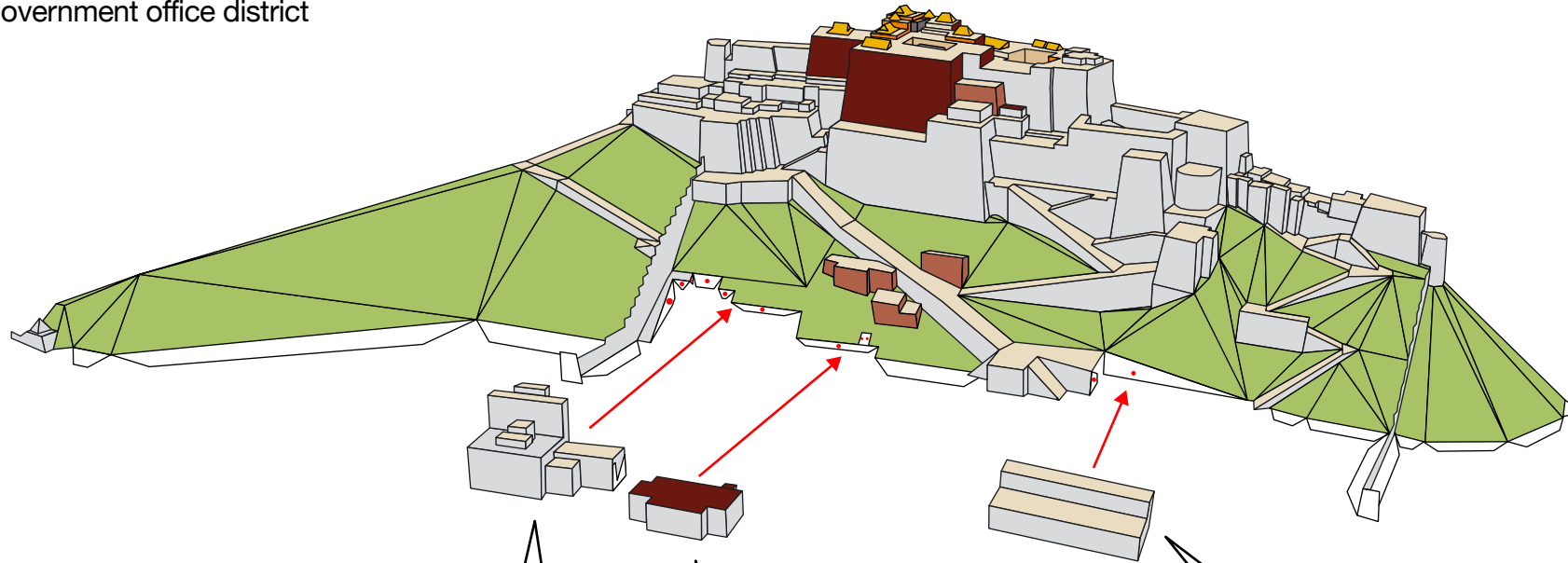

H. Government office district

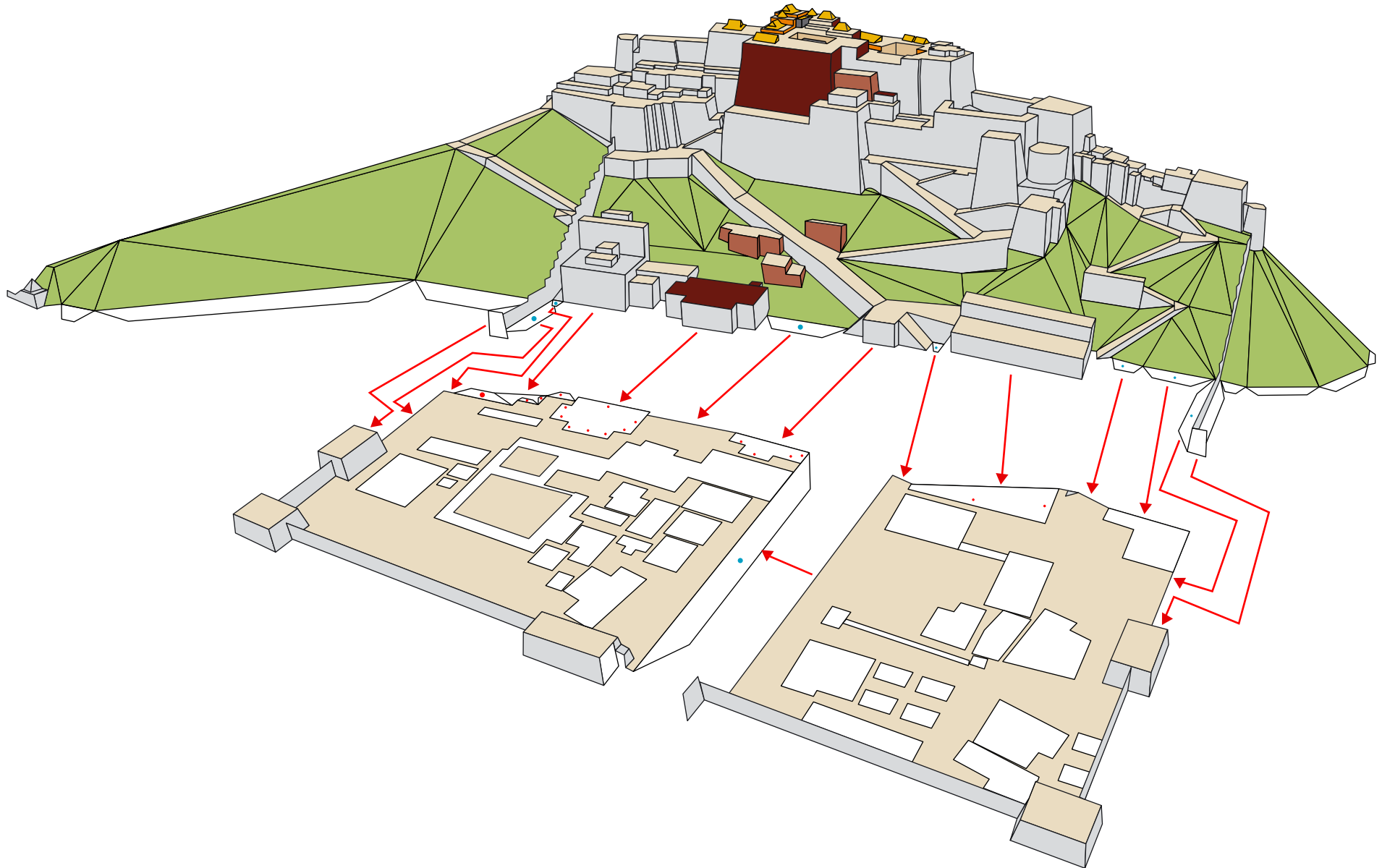

Potala Palace, China : Assembly Instructions

H. Government office district

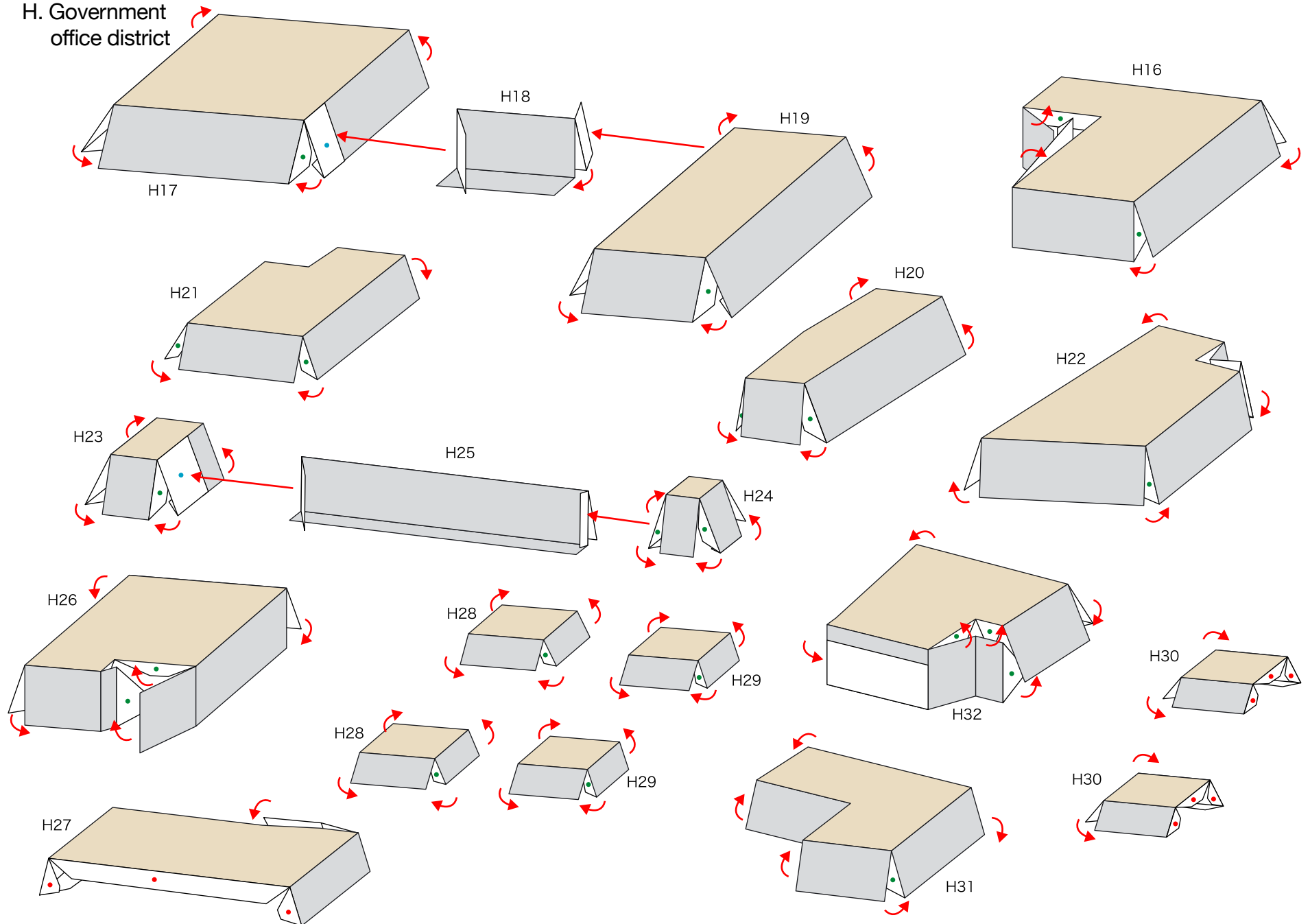

Potala Palace, China : Assembly Instructions

© Canon Inc. © T.Ichiyama



H. Government office district

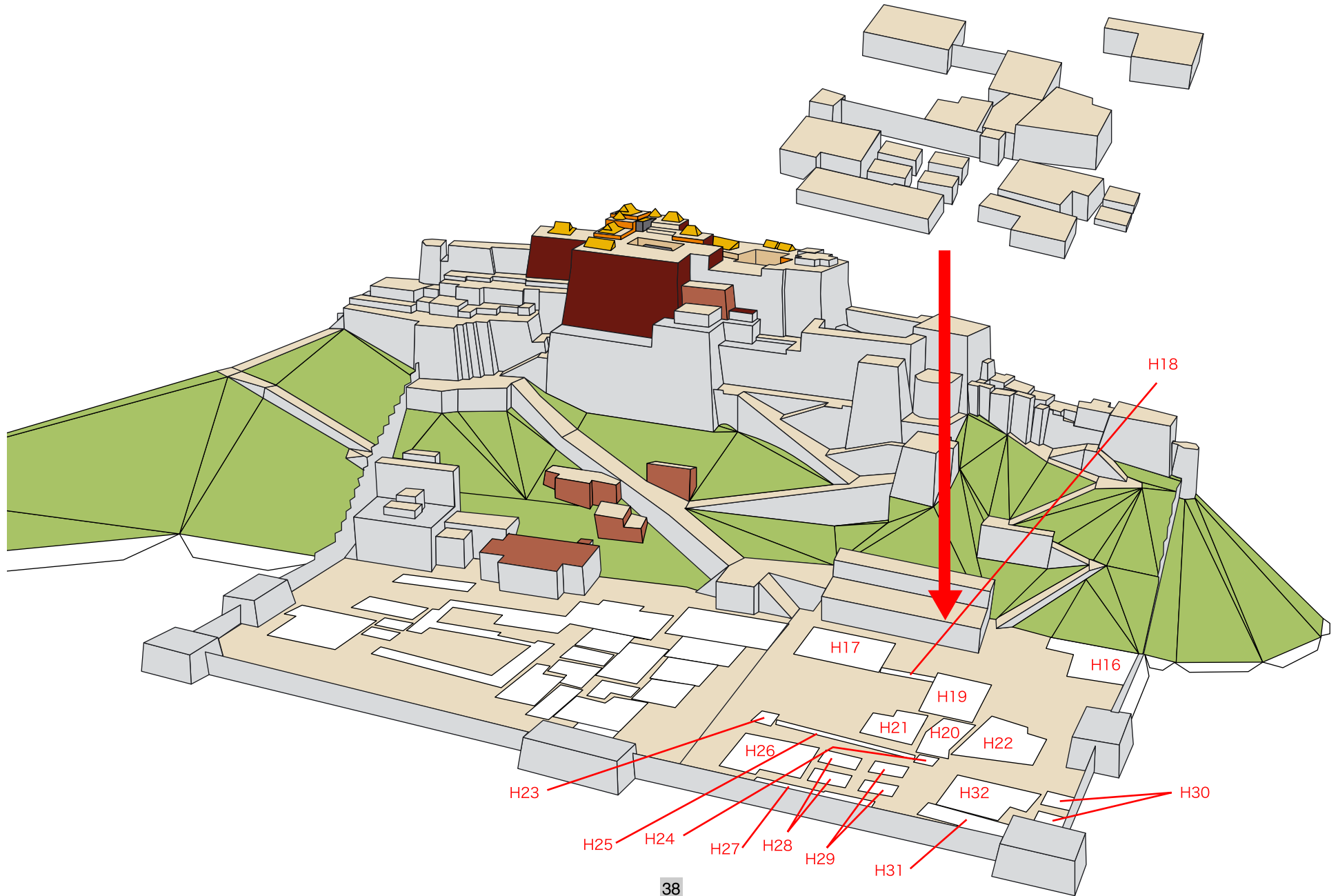

H. Government office district

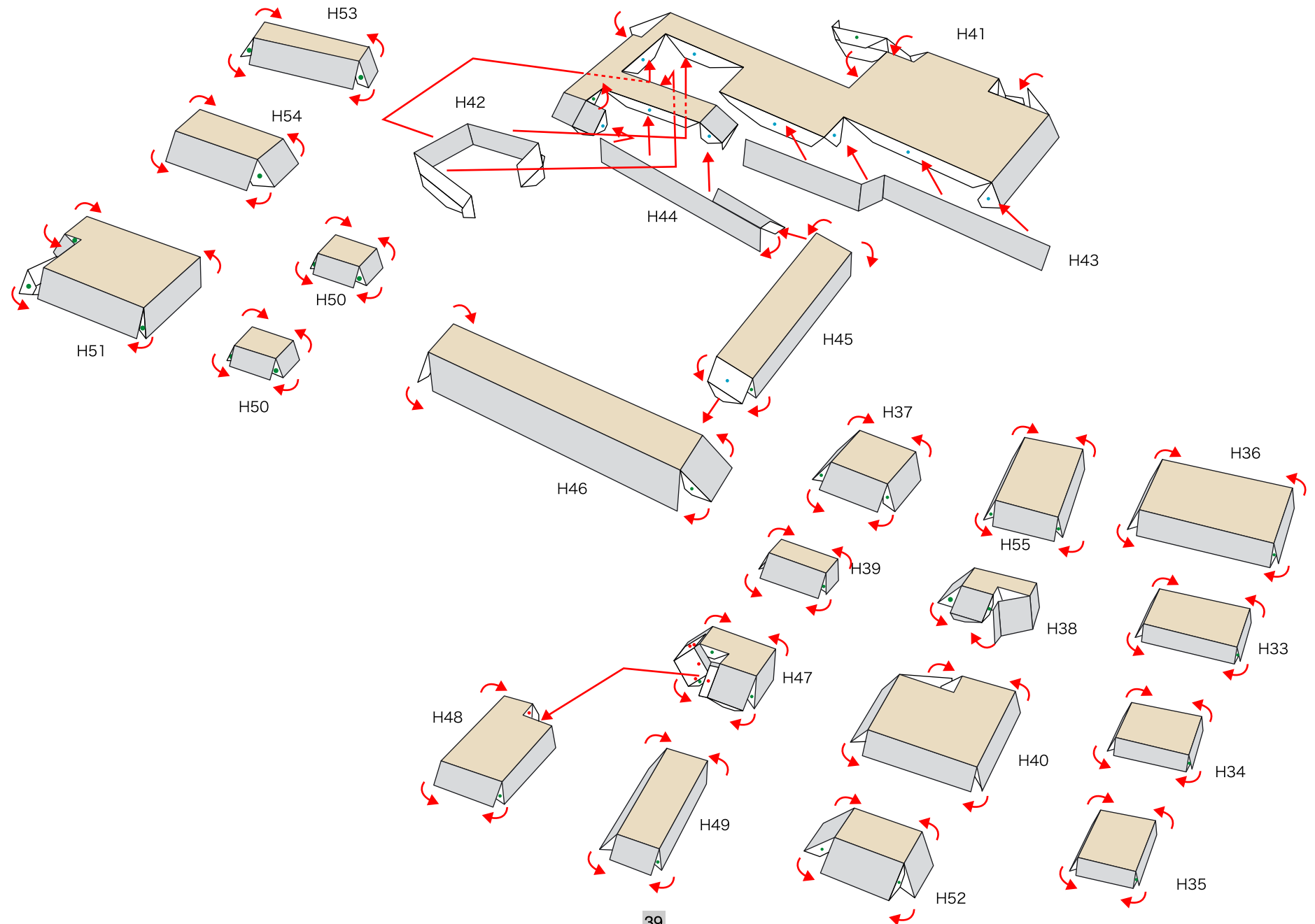

Potala Palace, China : Assembly Instructions

© Canon Inc. © T.Ichihama



H. Government office district

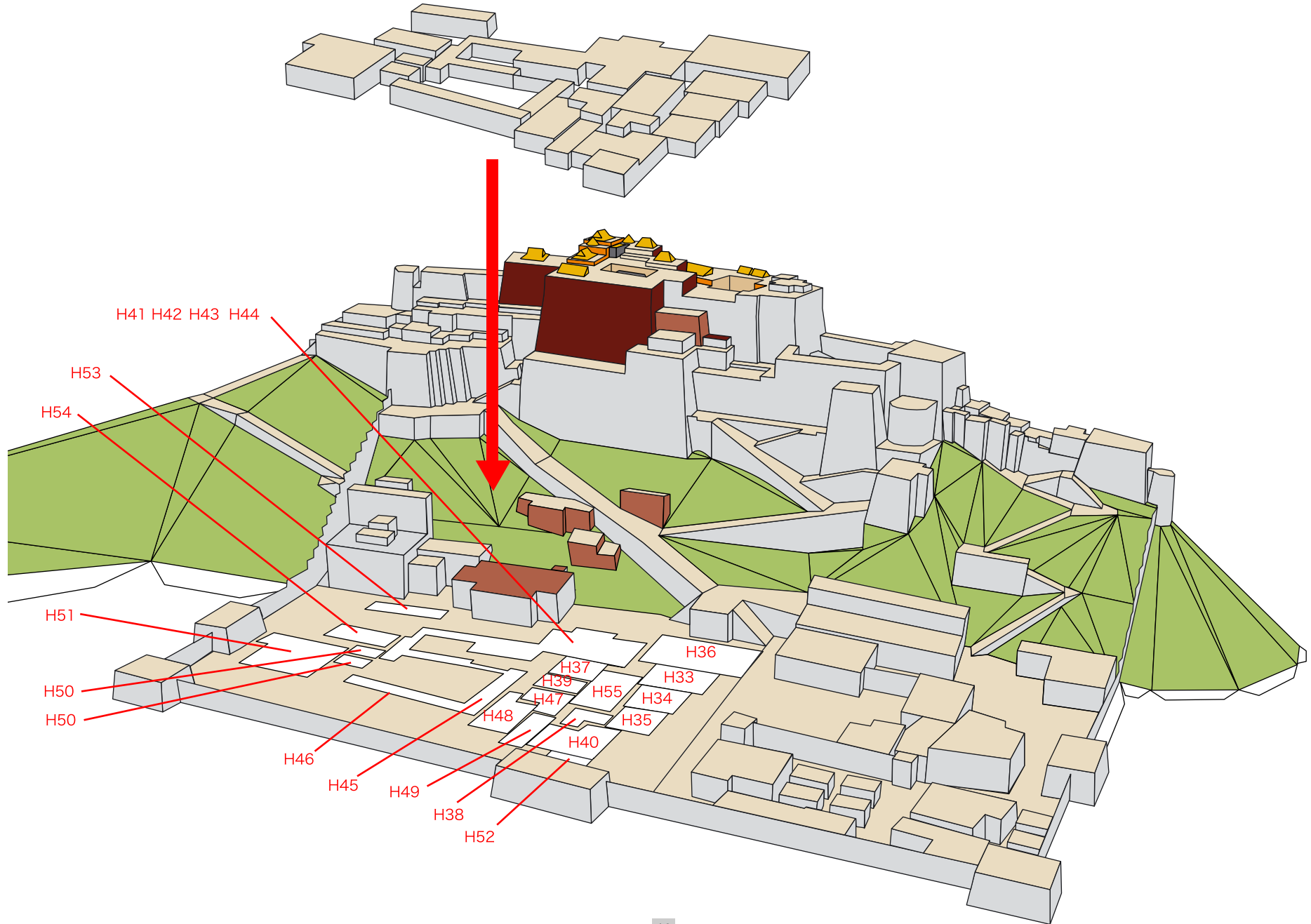

I. Base

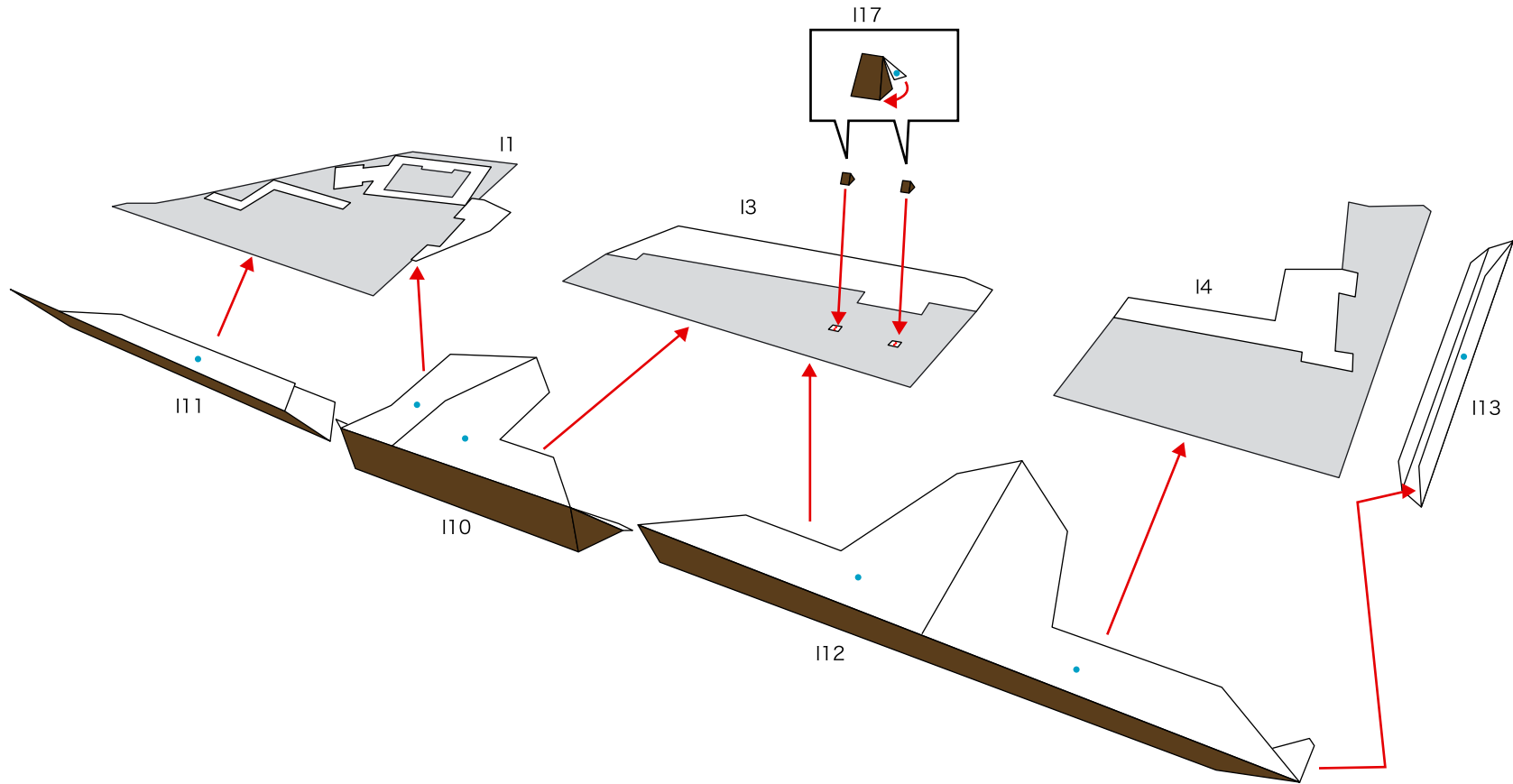

I. Base

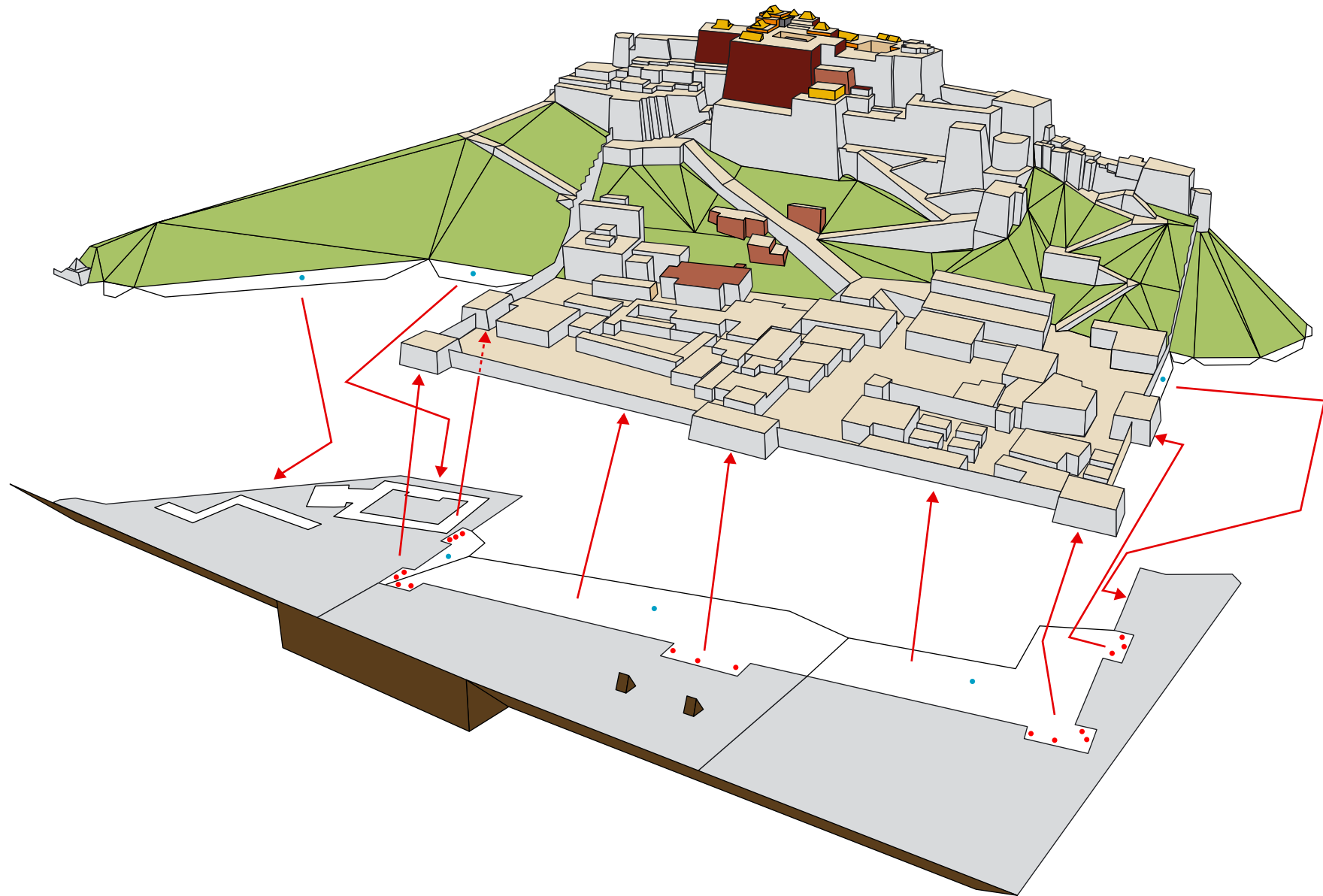

I. Base

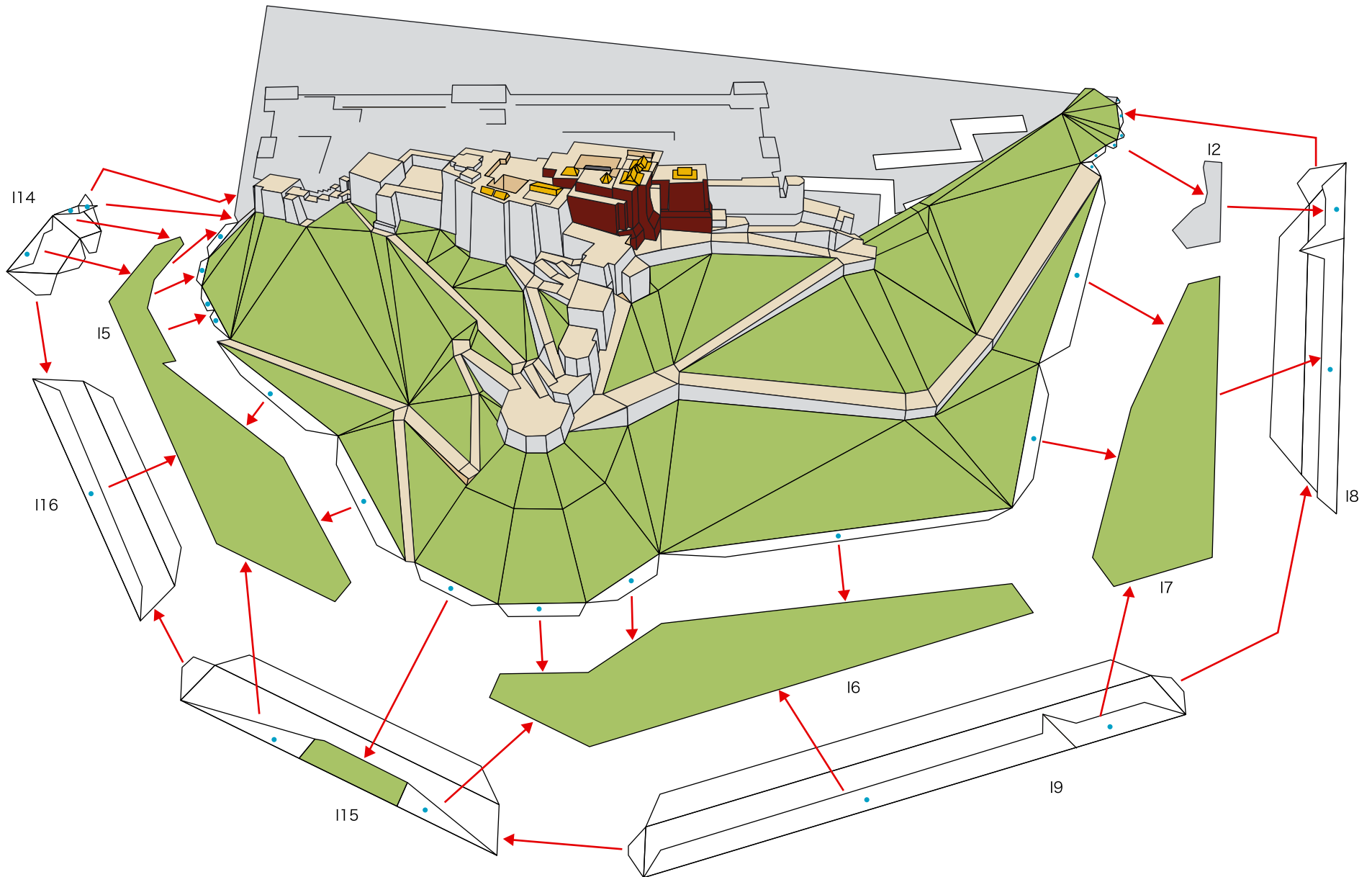

Potala Palace, China : Assembly Instructions

© Canon Inc. © T.Ichiyama



I. Base

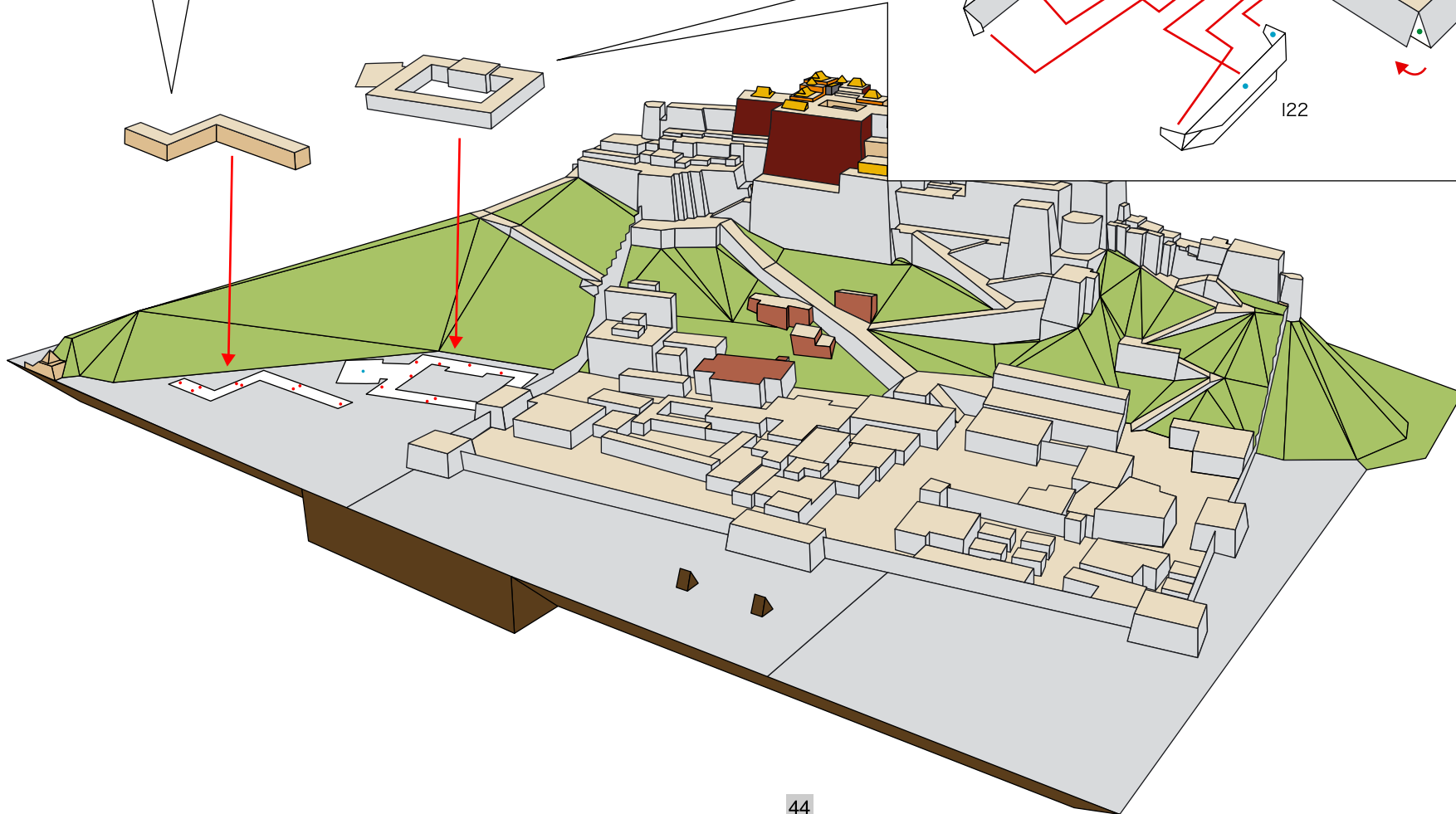
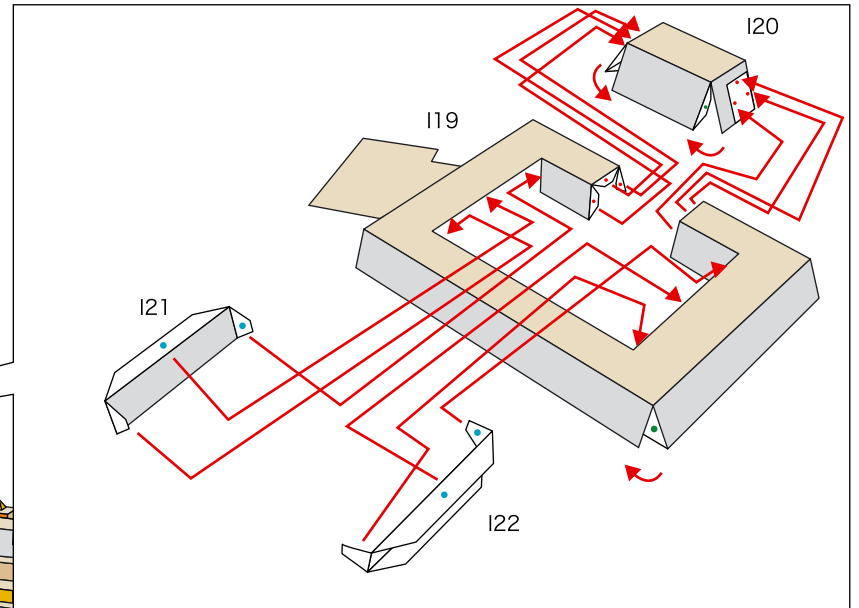
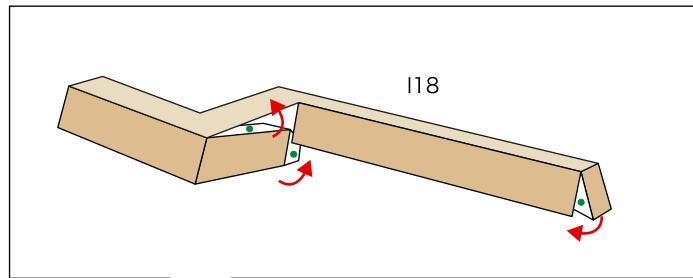

I. Base

Glue to the rear side of the parts.

