

(4-1)

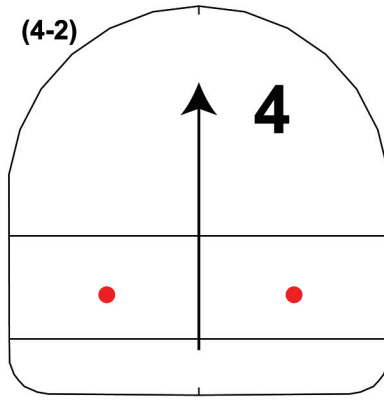

(4-2)

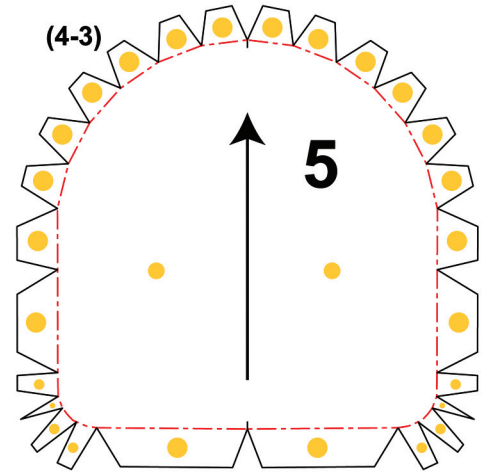

(4-3)

• (4-4)\*

(4-5) (4-5)\*

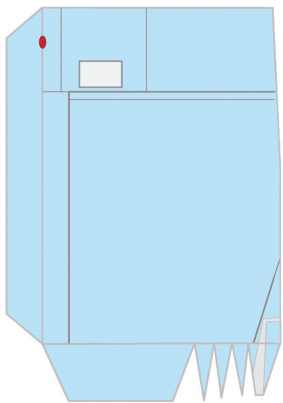

(4-4)

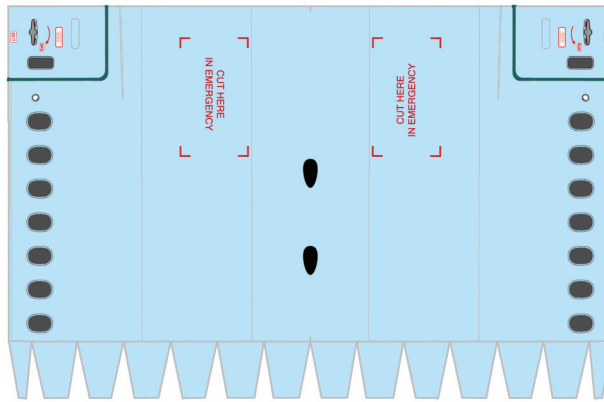

(4-6)

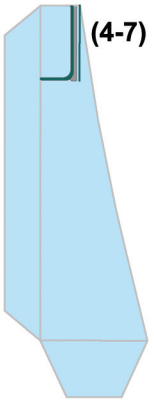
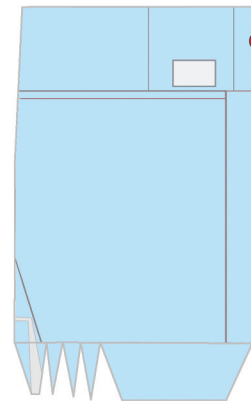

(4-7)

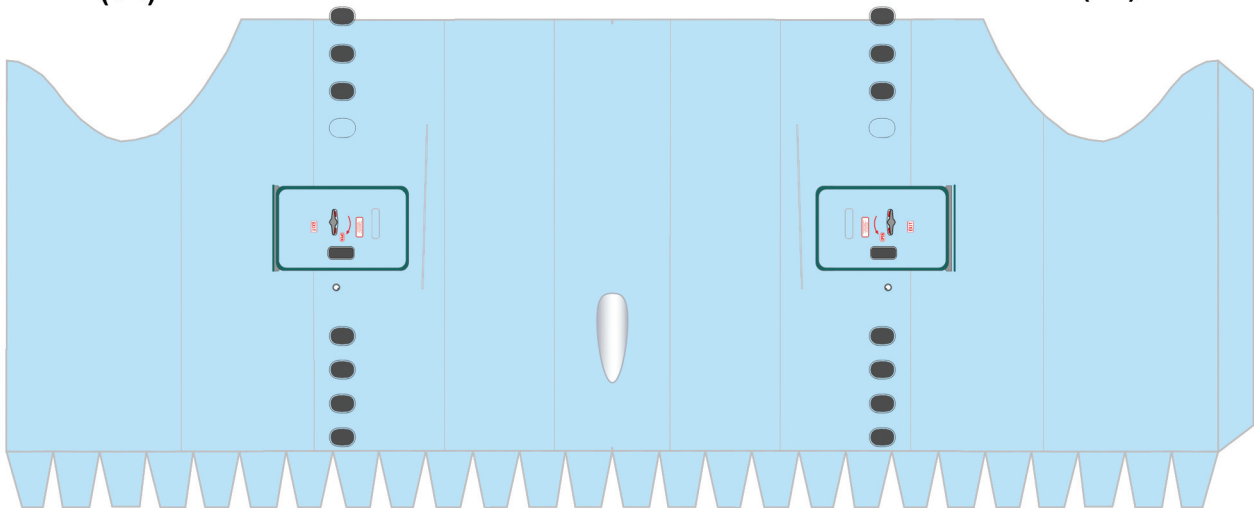

(4-9)

(4-8)

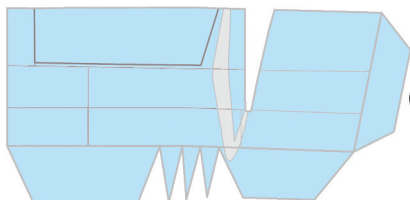
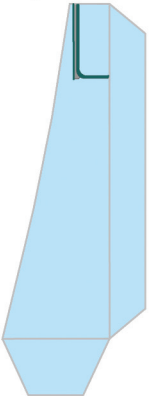

(4-10)



(4-9)\*

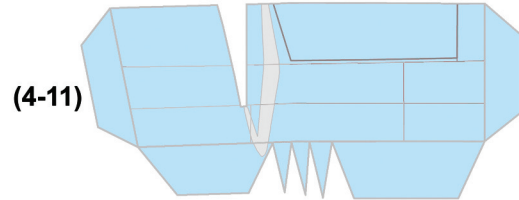

(4-11)



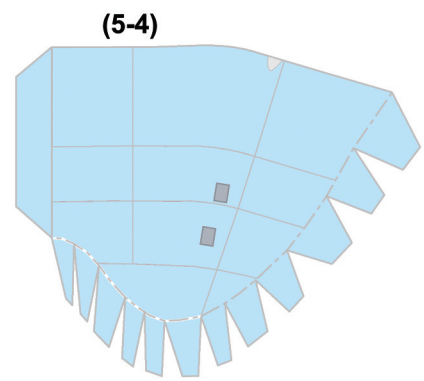
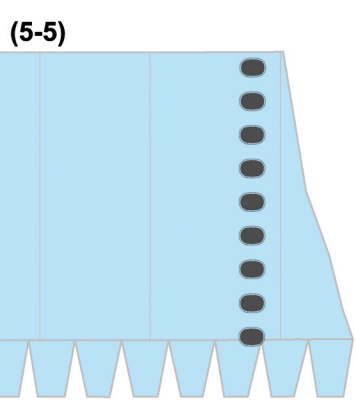
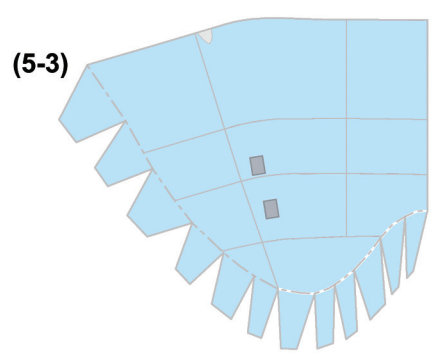
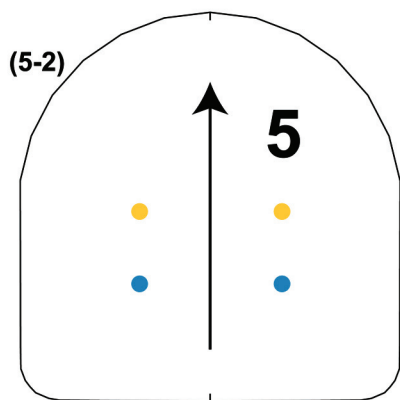
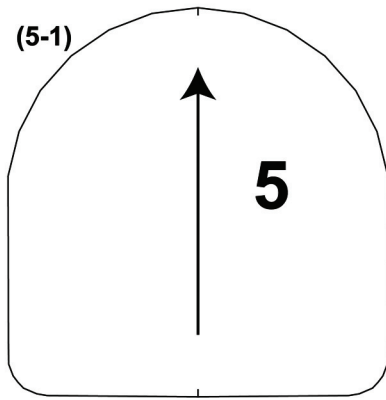

(5-6)

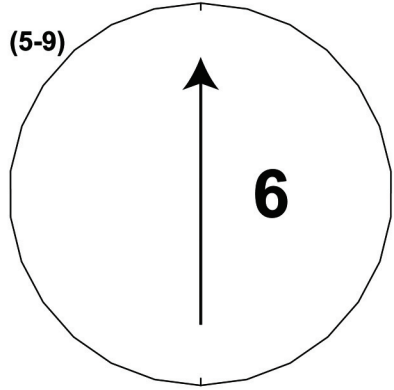
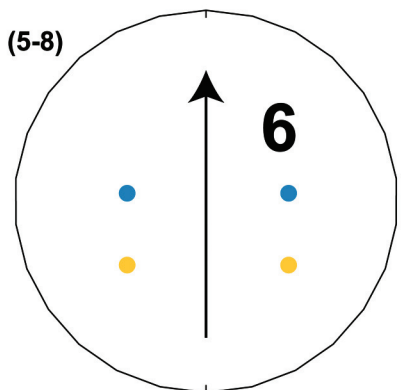
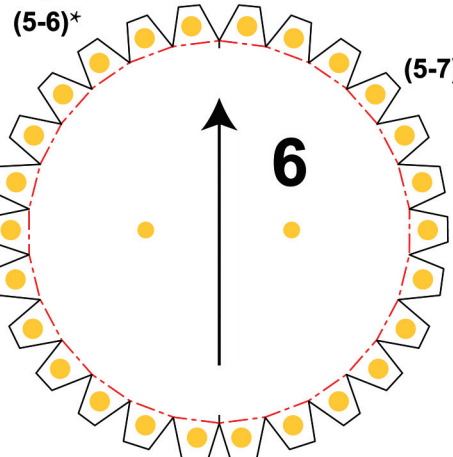
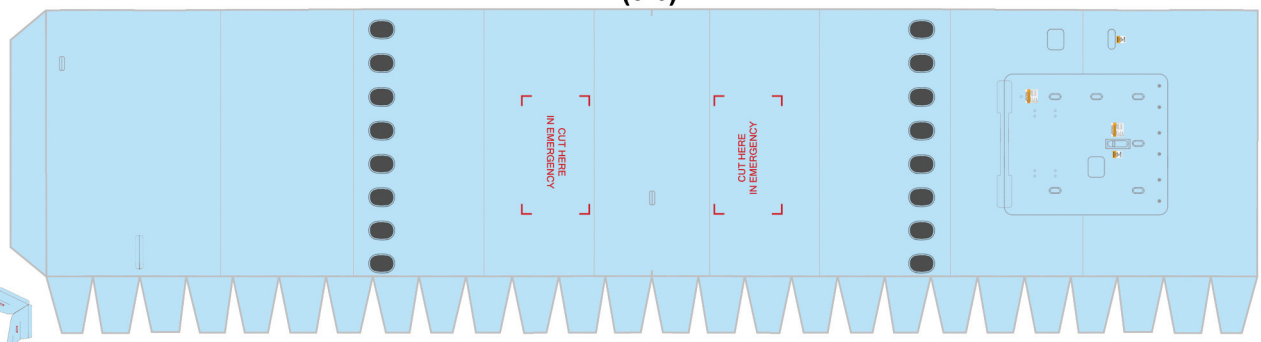

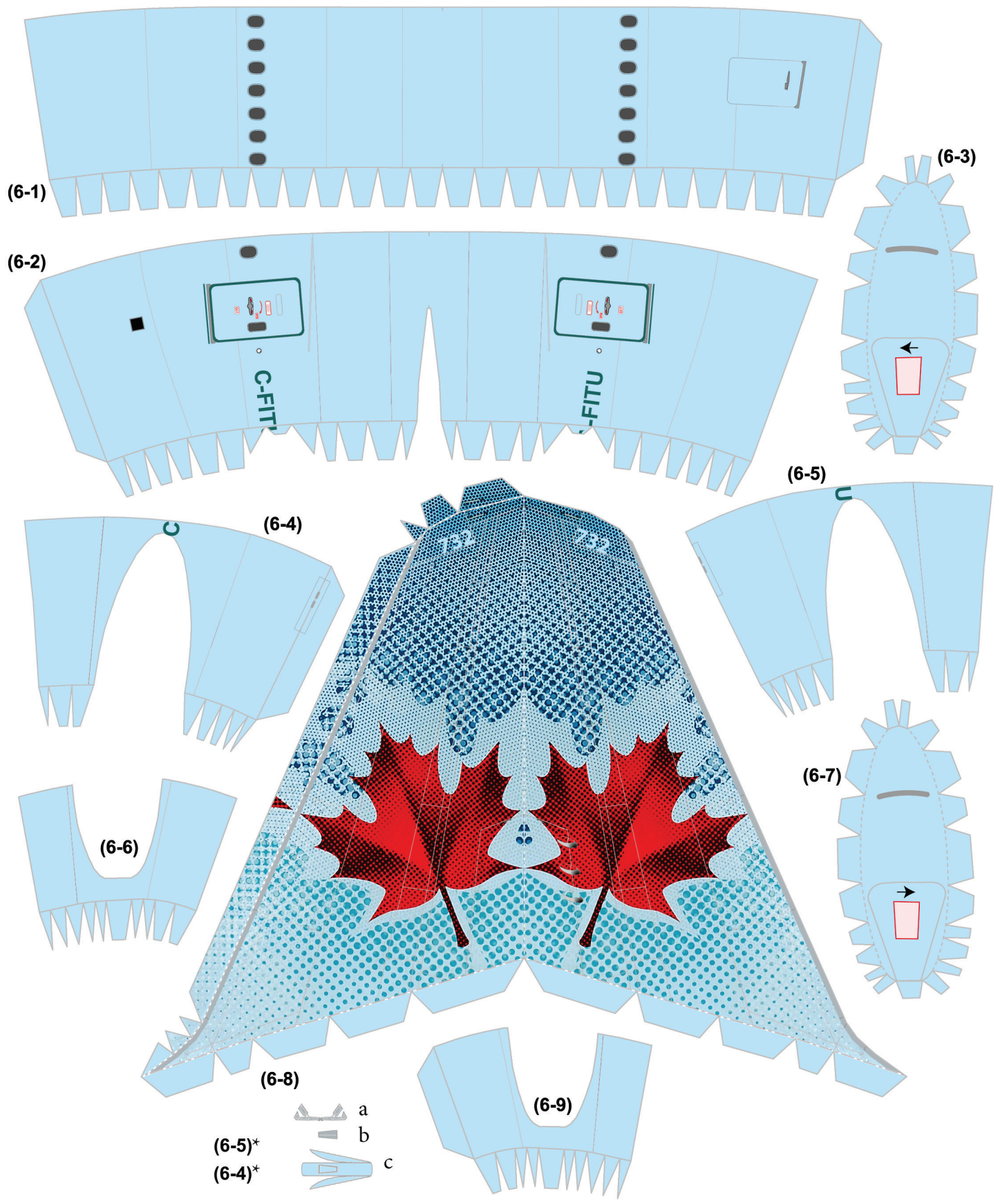

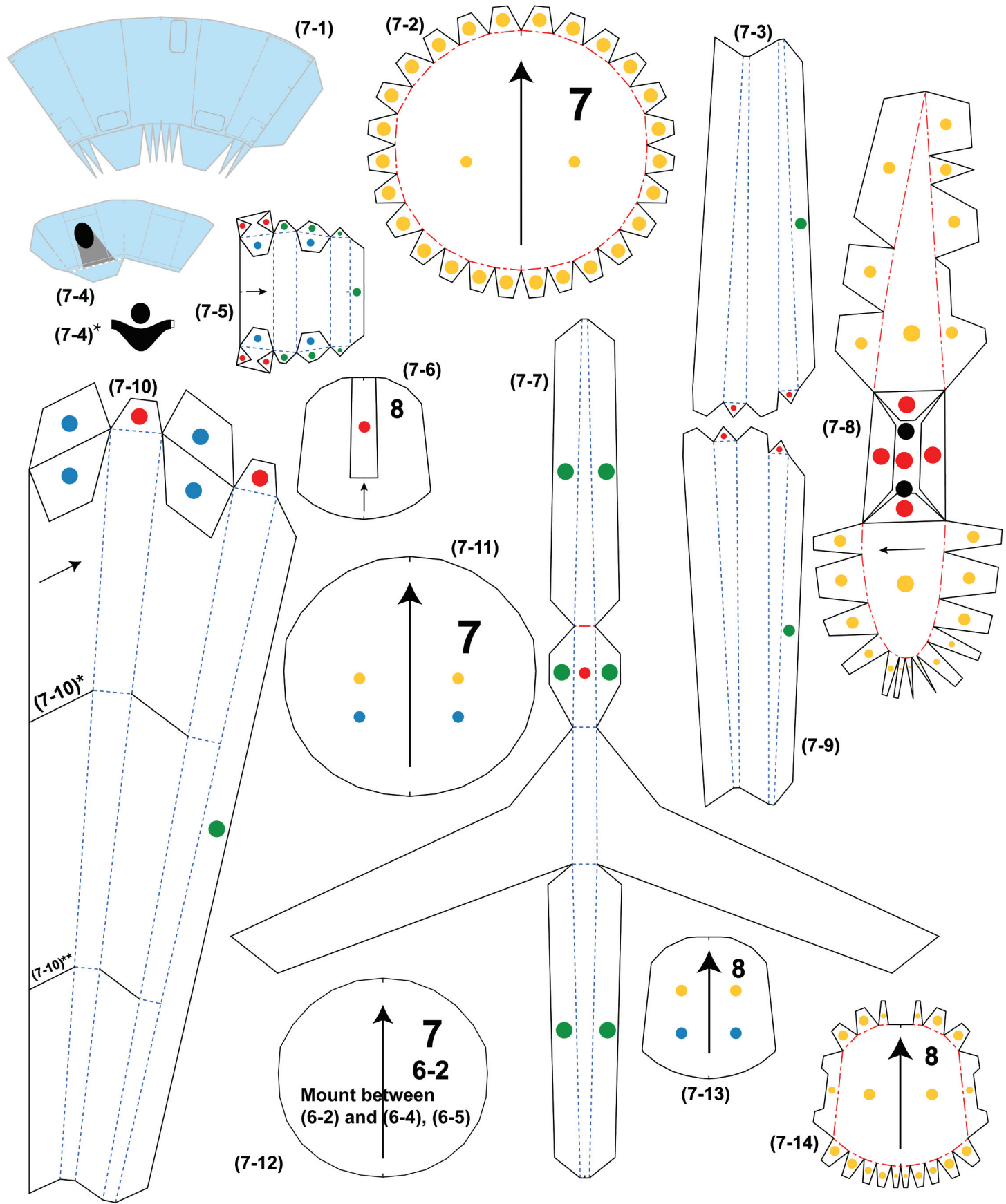

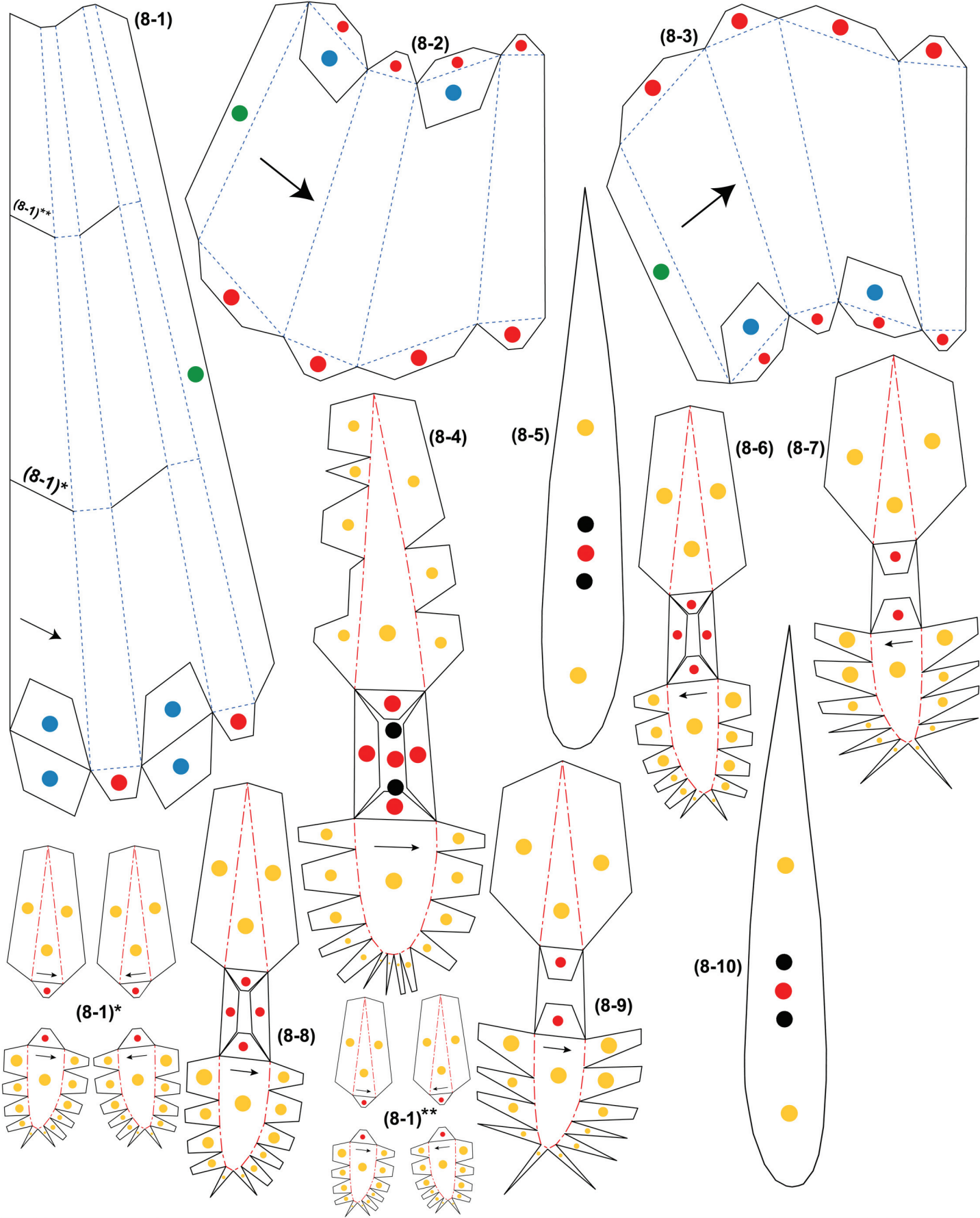



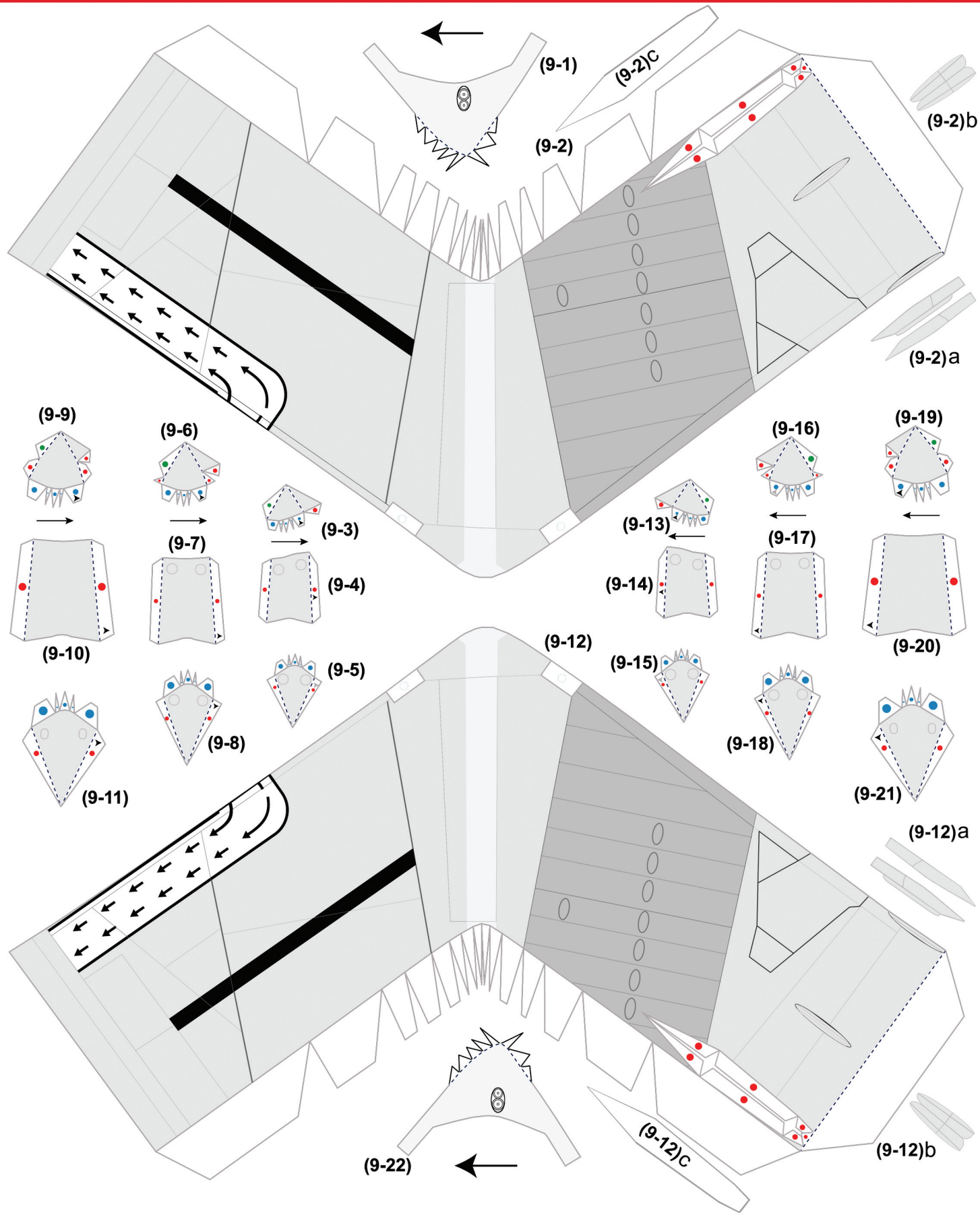



(10-2)

(10-2)a

(10-3)

(10-4)

(10-2)d

(10-5)

(10-2)e

(10-6)

(10-1)

(10-7)

(10-2)b

(10-9)

(10-8)

(10-10)

(10-11)

(10-12)

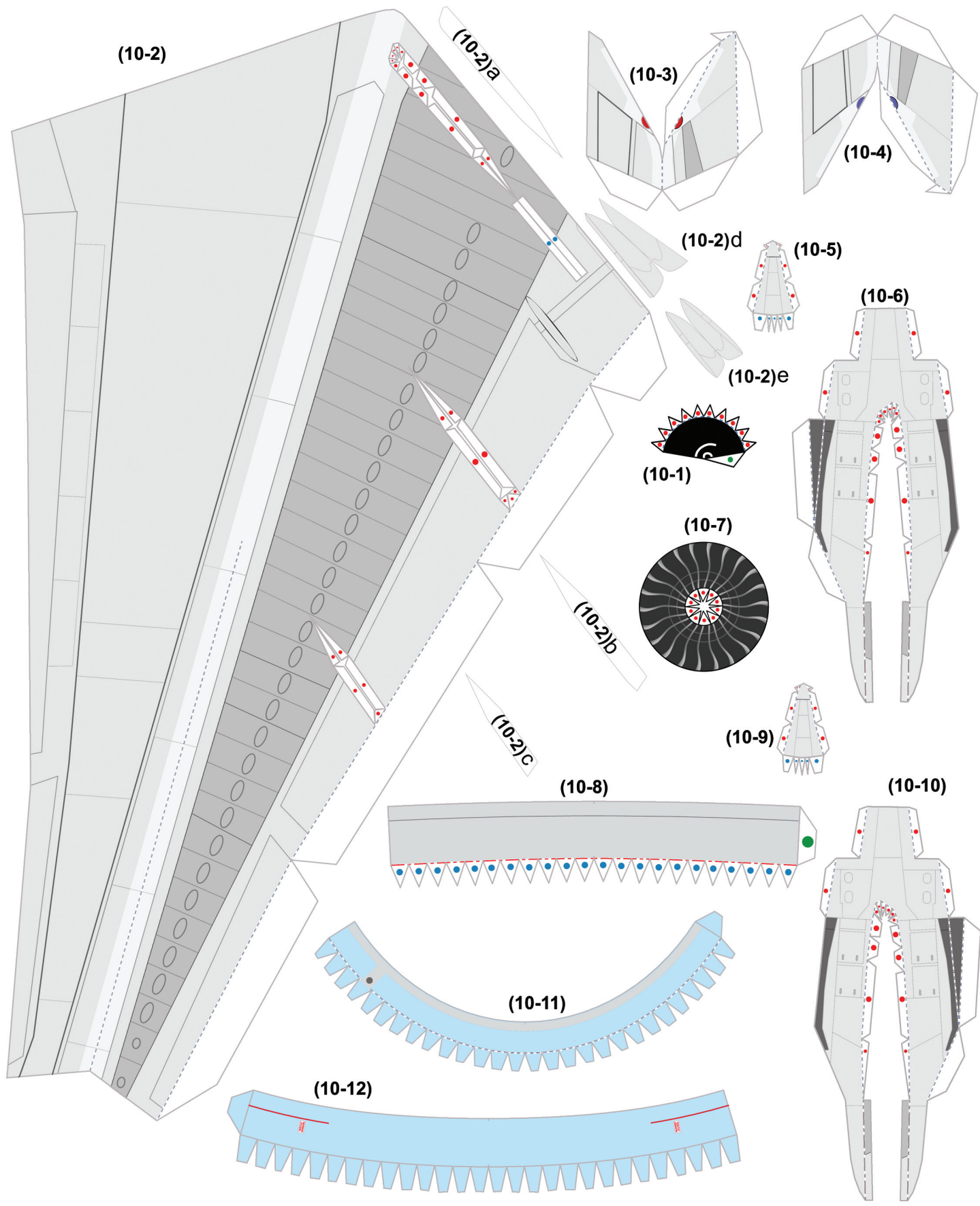

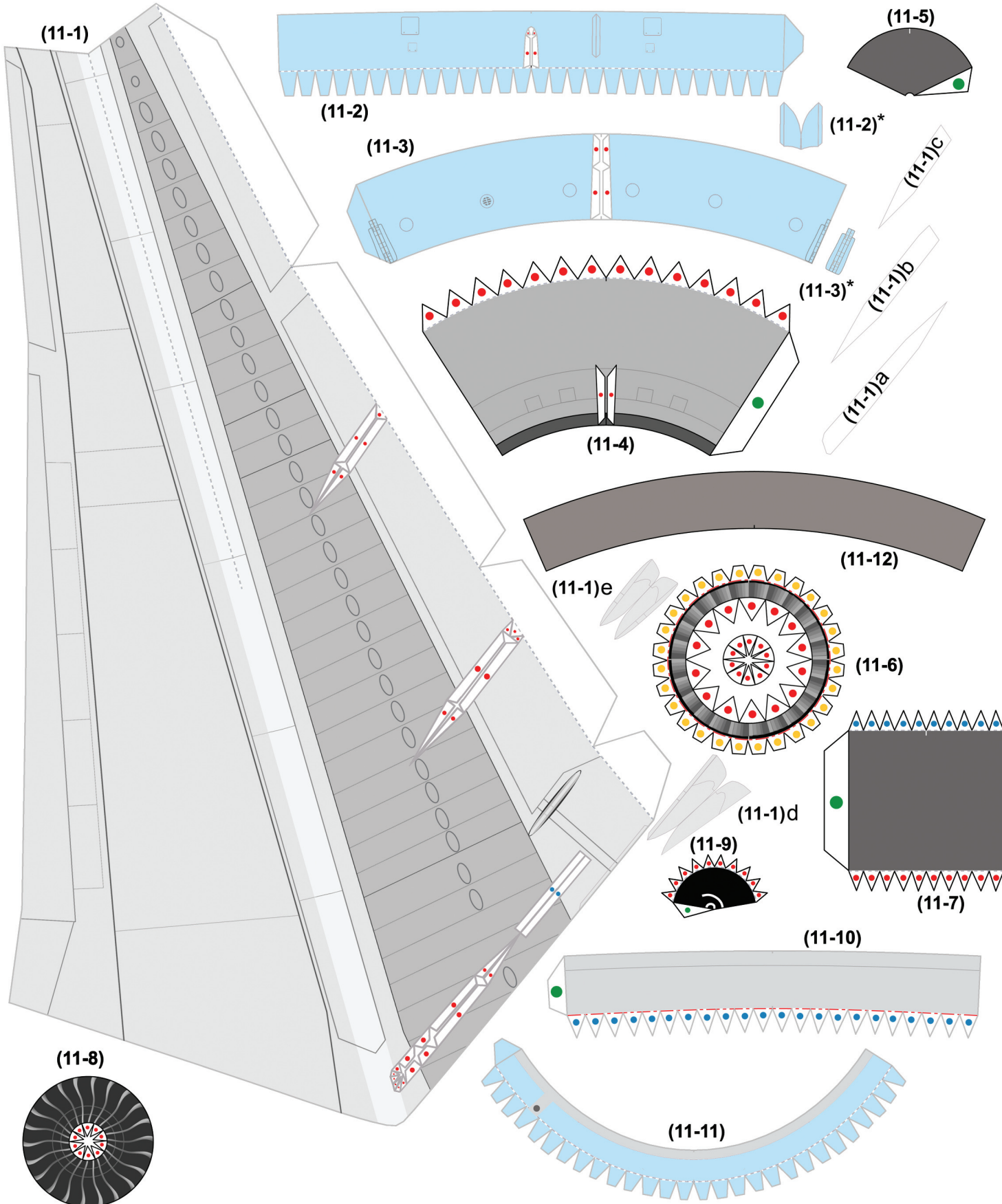

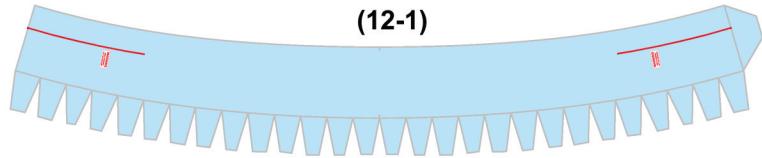

(12-1)

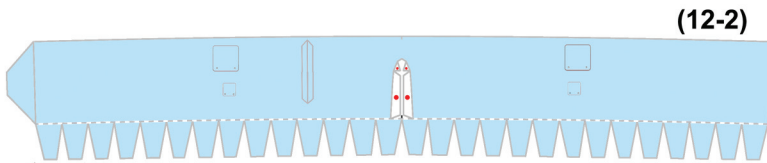

(12-2)

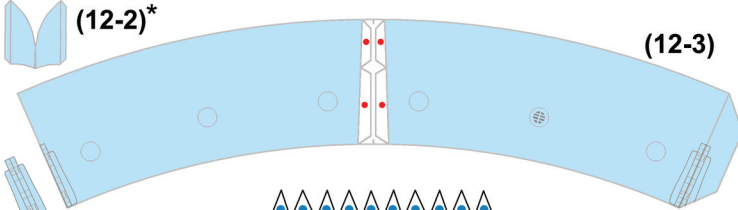

(12-3)



(12-2)\*

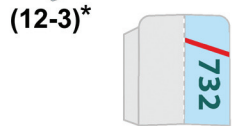

(12-3)\*

(12-6)

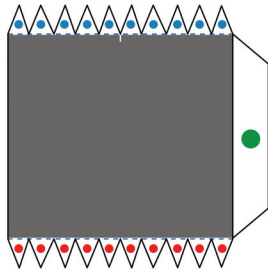

(12-8)



(12-5)

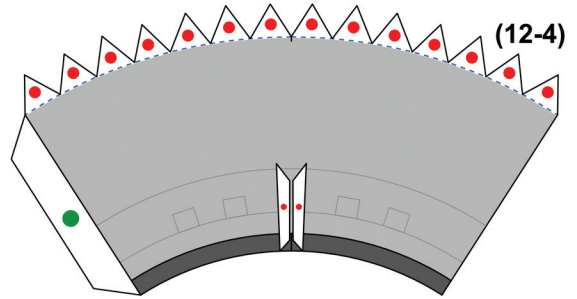

(12-4)

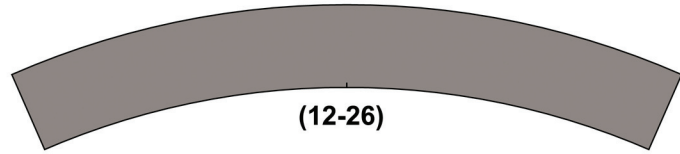

(12-26)

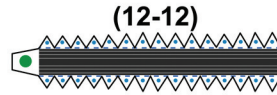

(12-12)

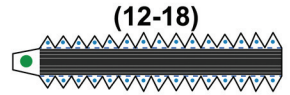

(12-18)



(12-13)



(12-14)



(12-19)



(12-20)



(12-15)



(12-16)



(12-17)



(12-21)



(12-22)



(12-23)

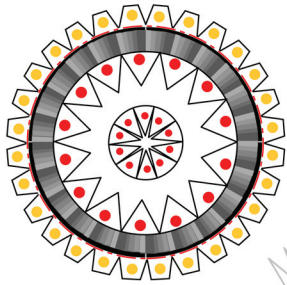

(12-9)

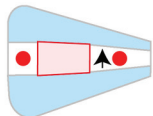

(12-24)

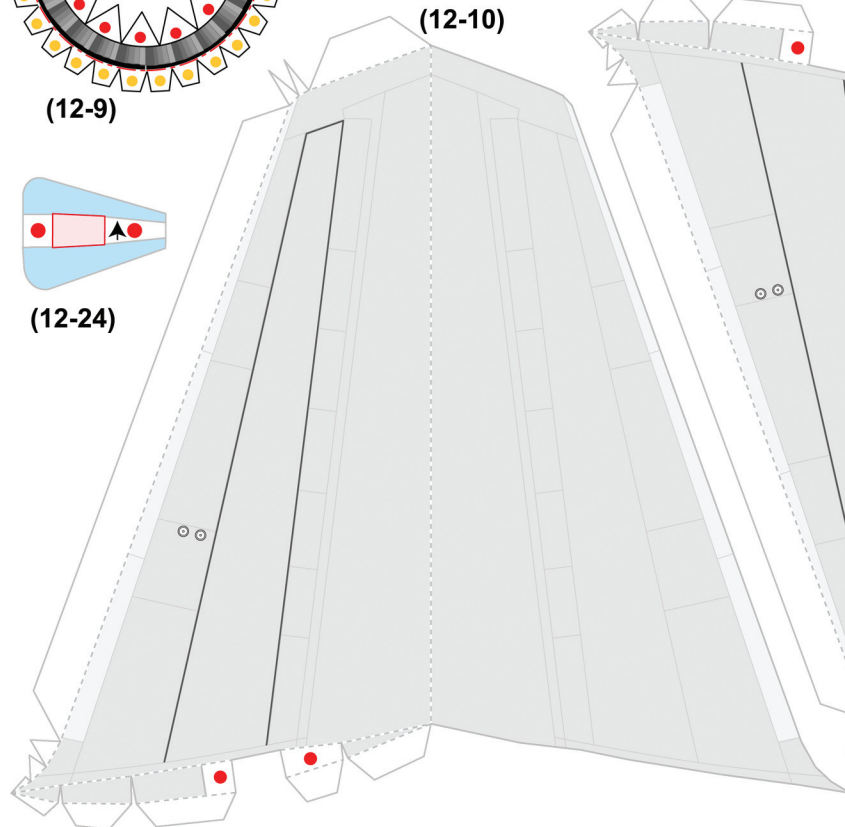

(12-10)

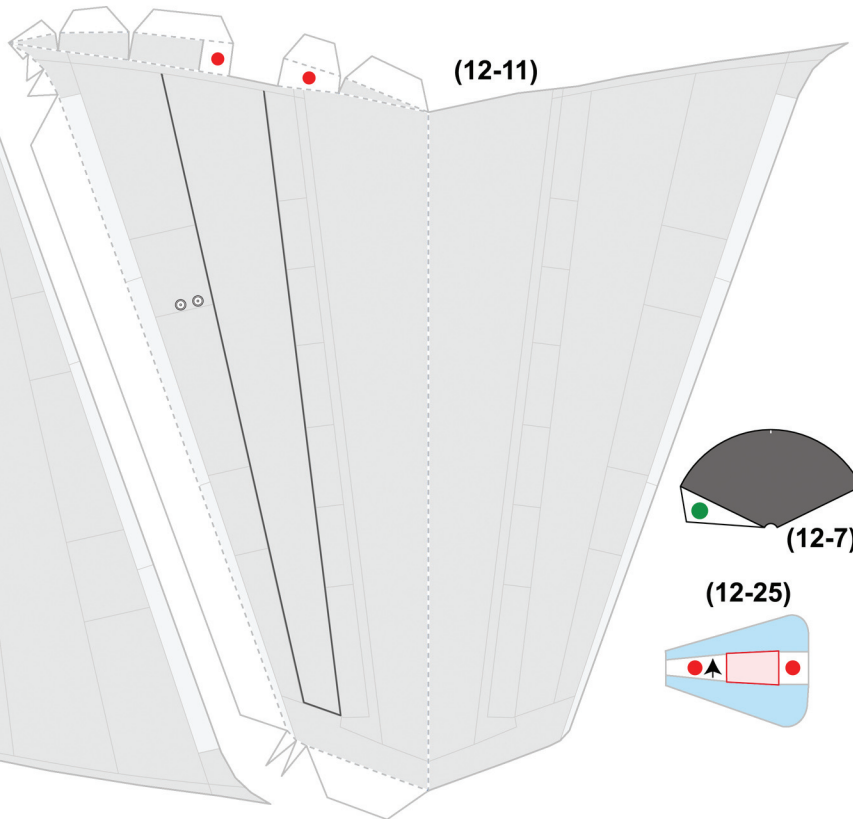

(12-11)

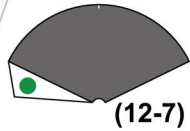

(12-7)

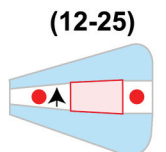

(12-25)

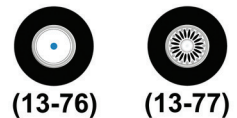
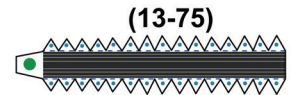
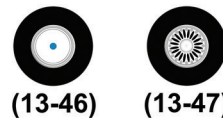
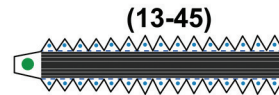
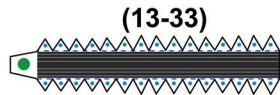
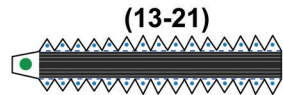
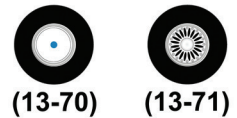
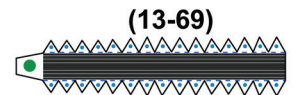
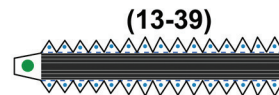
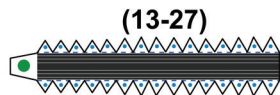
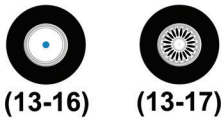
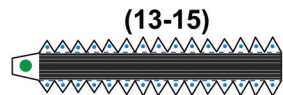
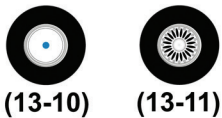
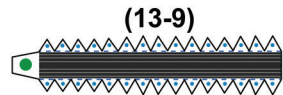
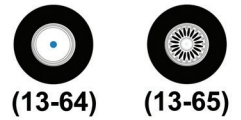
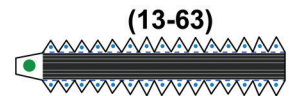
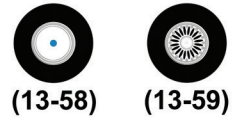
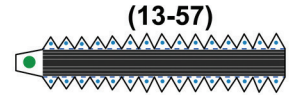
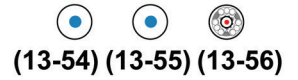
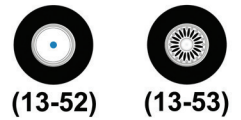
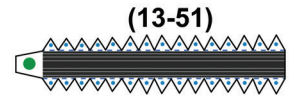
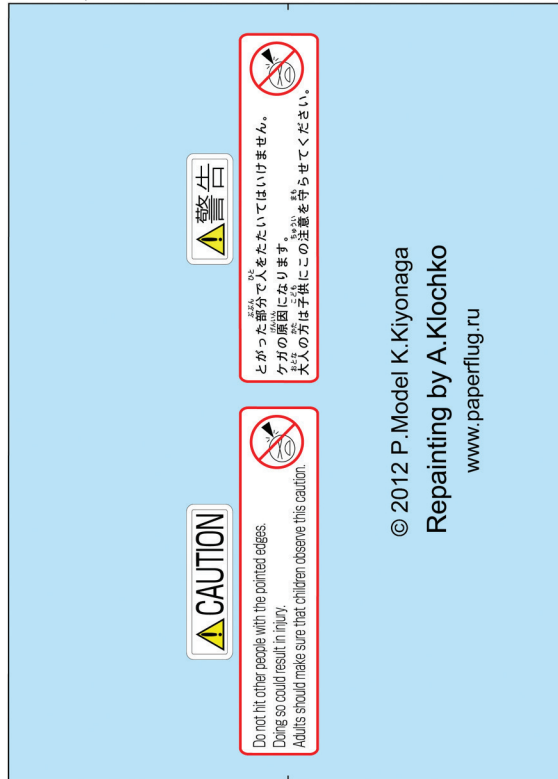
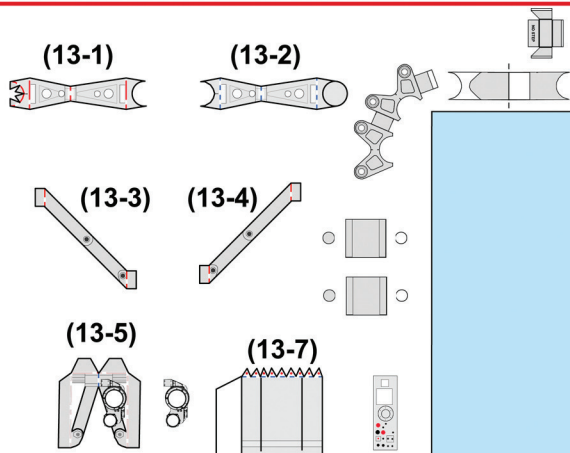

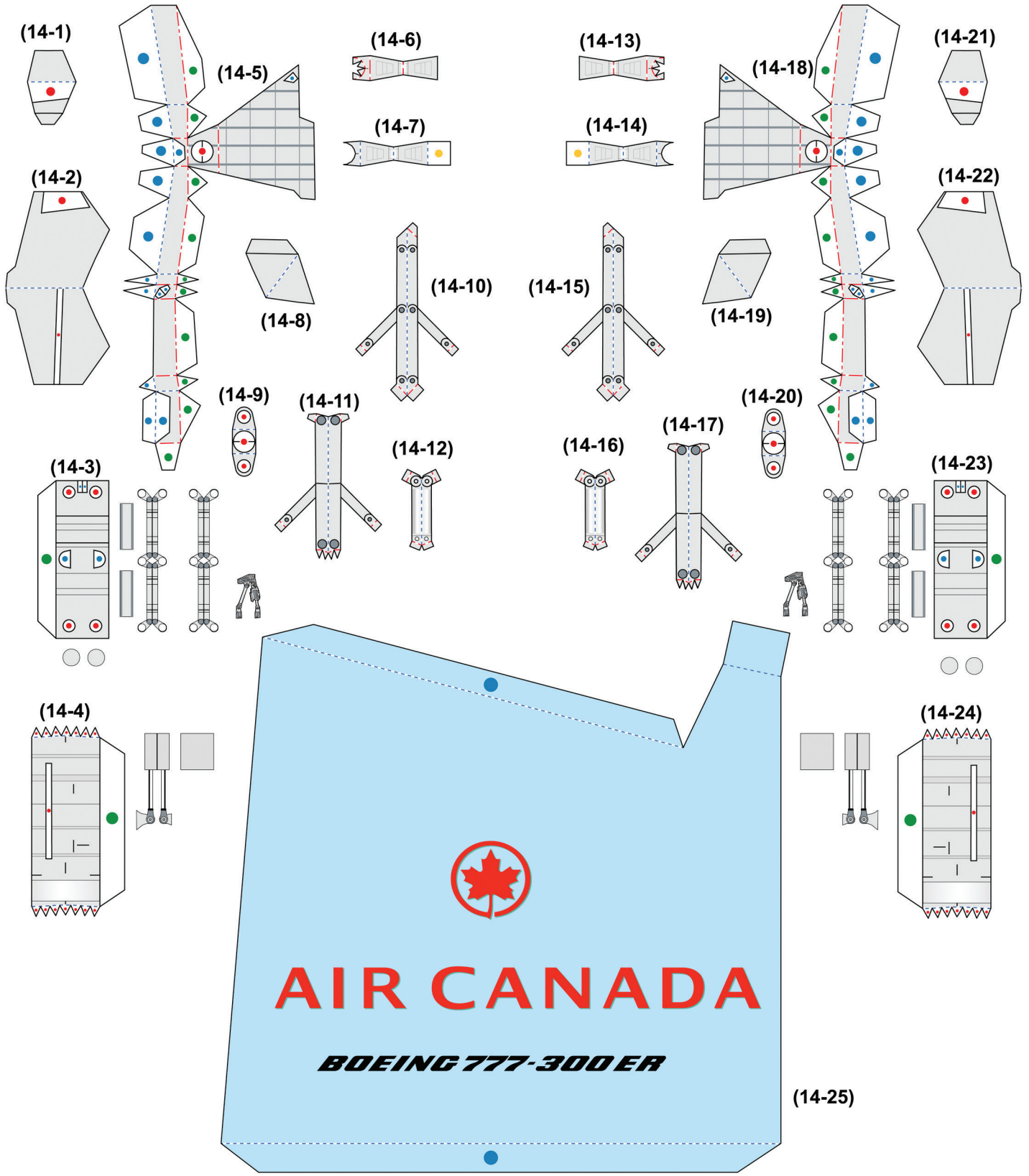

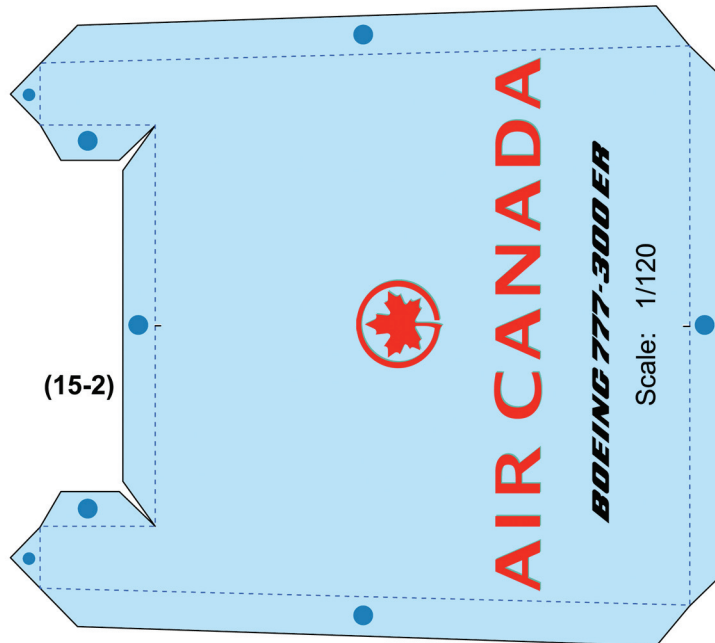
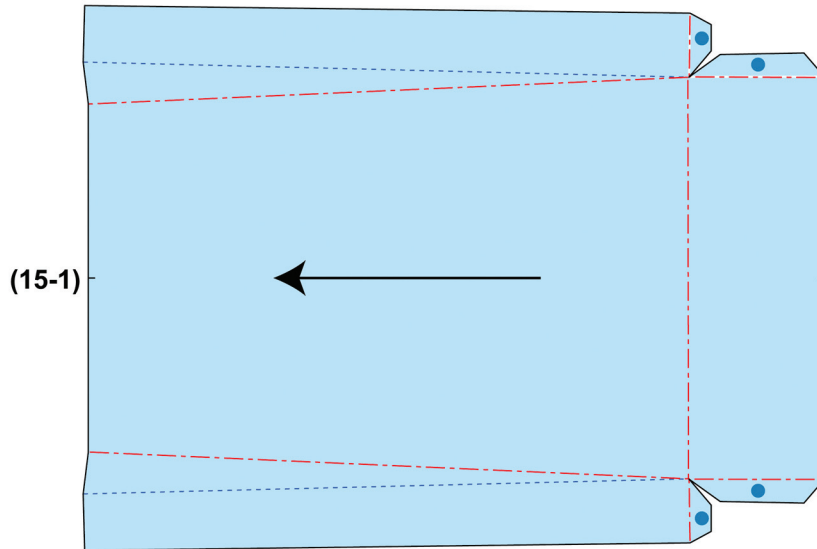



(16-1)

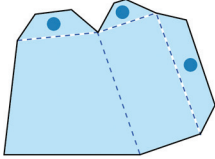

(16-2)

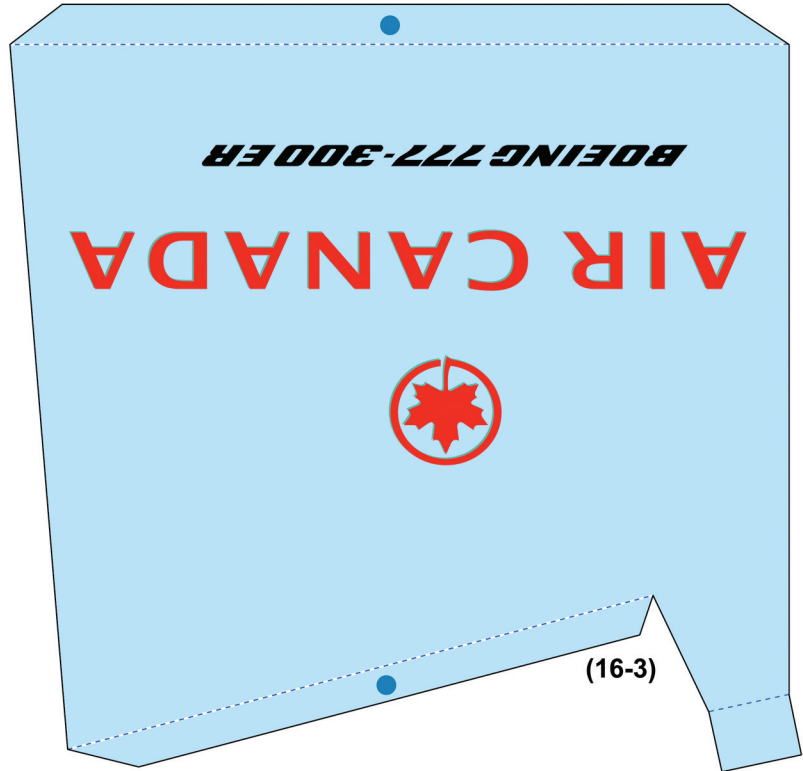
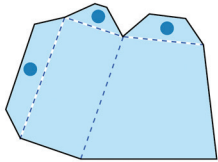

(16-4)

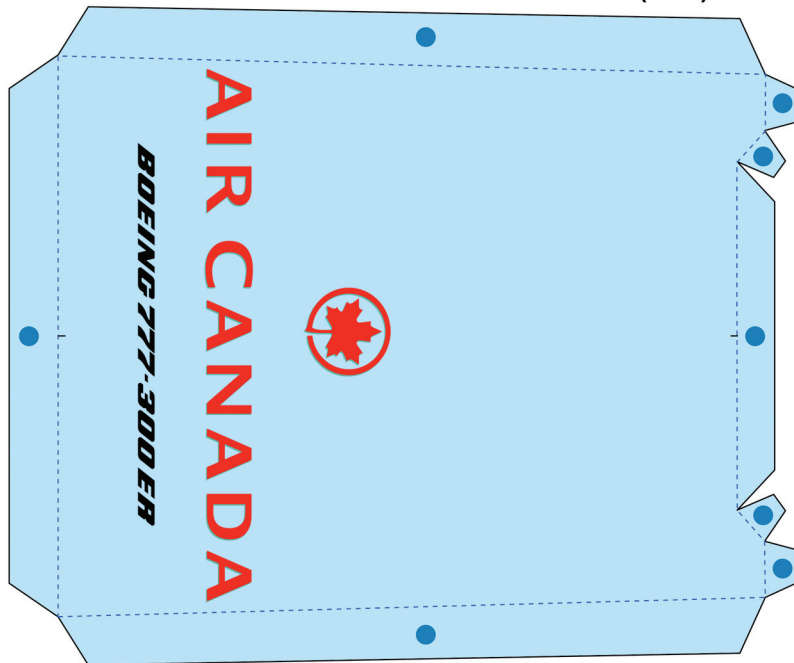



(3-4)\*\*  
(3-5)

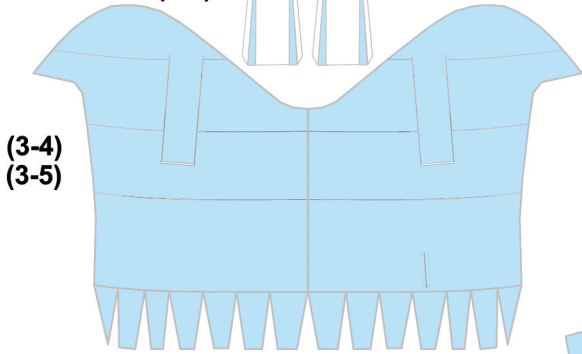

(3-4)  
(3-5)

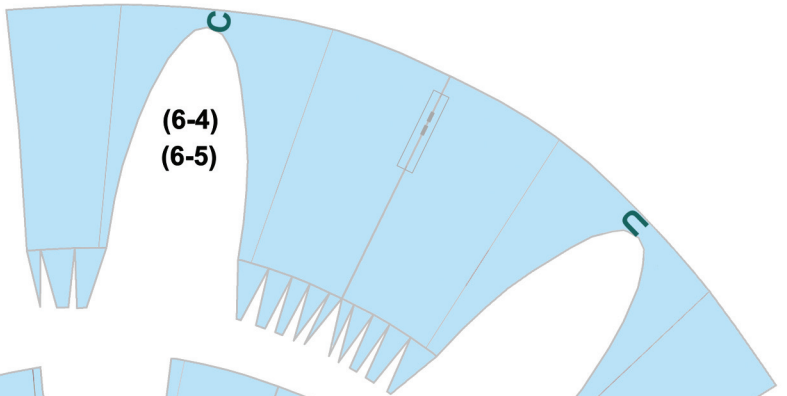

(6-4)  
(6-5)

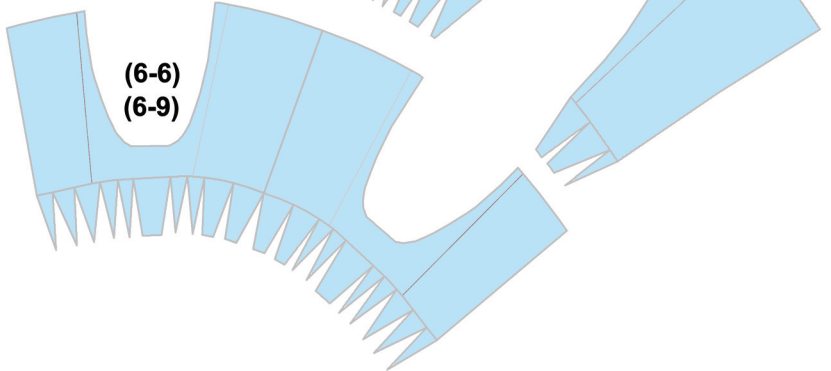

(6-6)  
(6-9)

(3-7)  
(3-8)

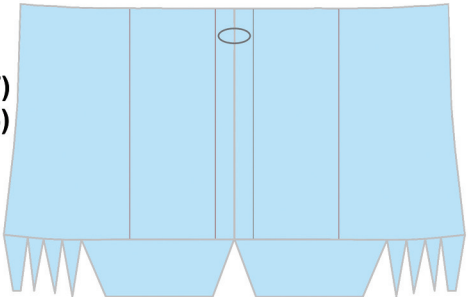

(4-4)\*  
(4-6)

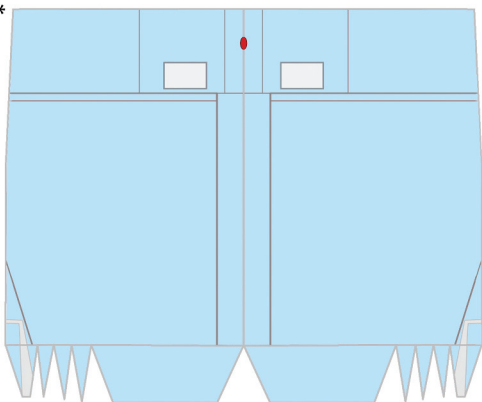

(4-4)  
(4-6)

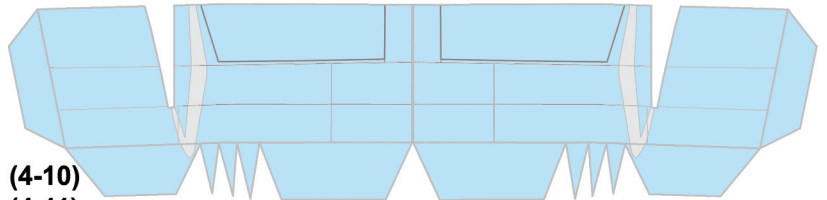

(4-10)  
(4-11)

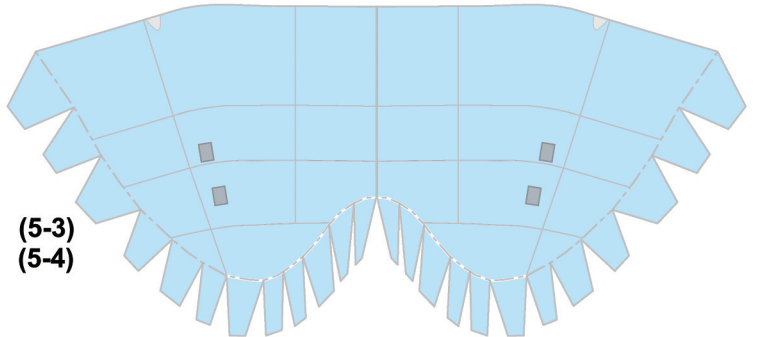

(5-3)  
(5-4)

(4-5)  
(4-7) (4-8) (4-5)\*

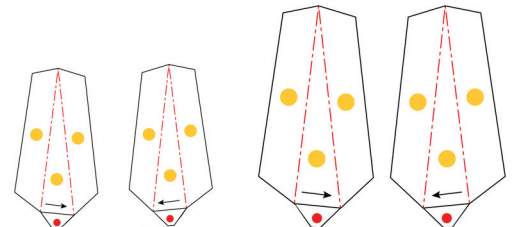
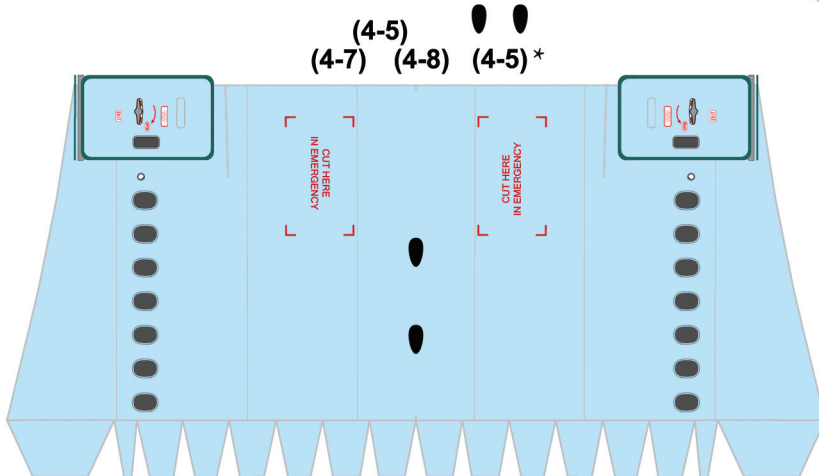

(7-10)\*\*

(7-10)\*

