

TOMB RAIDER

TOMB RAIDER II "40 FATHOMS" VIGNETTE

Tomb Raider II featured several underwater levels, in which Lara donned a now iconic SOLA wetsuit.

This time around, Lara even had a harpoon gun to battle scuba divers, barracudas and even great white sharks whilst under water (although it was often a much better choice to shoot your enemies from dry land... ;o)

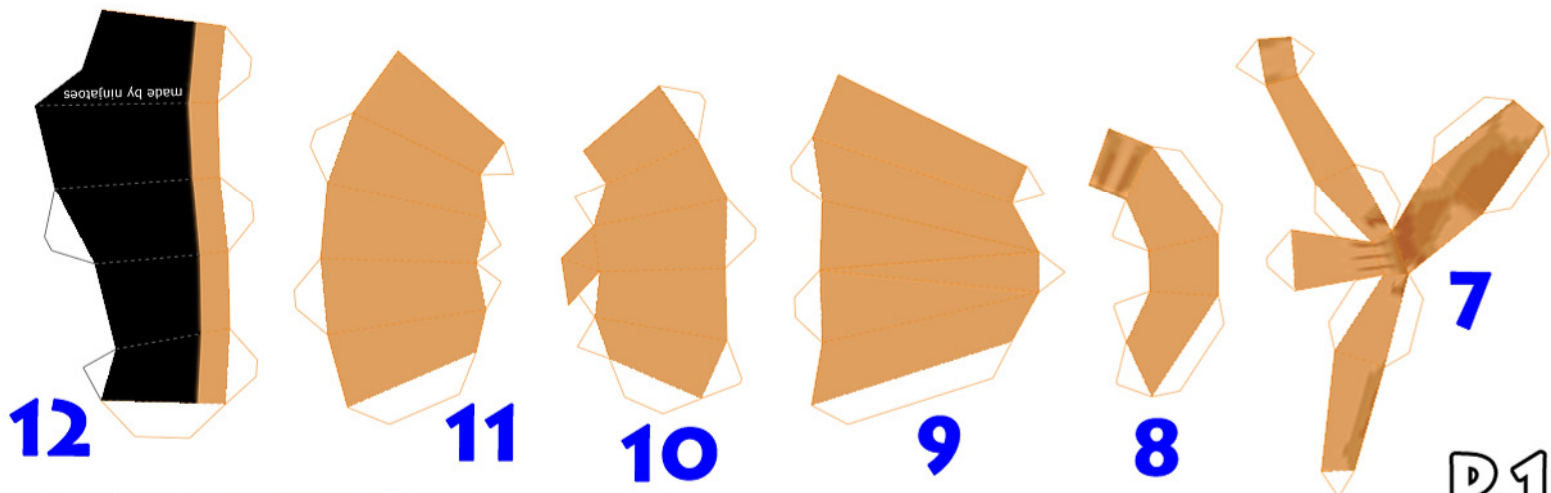
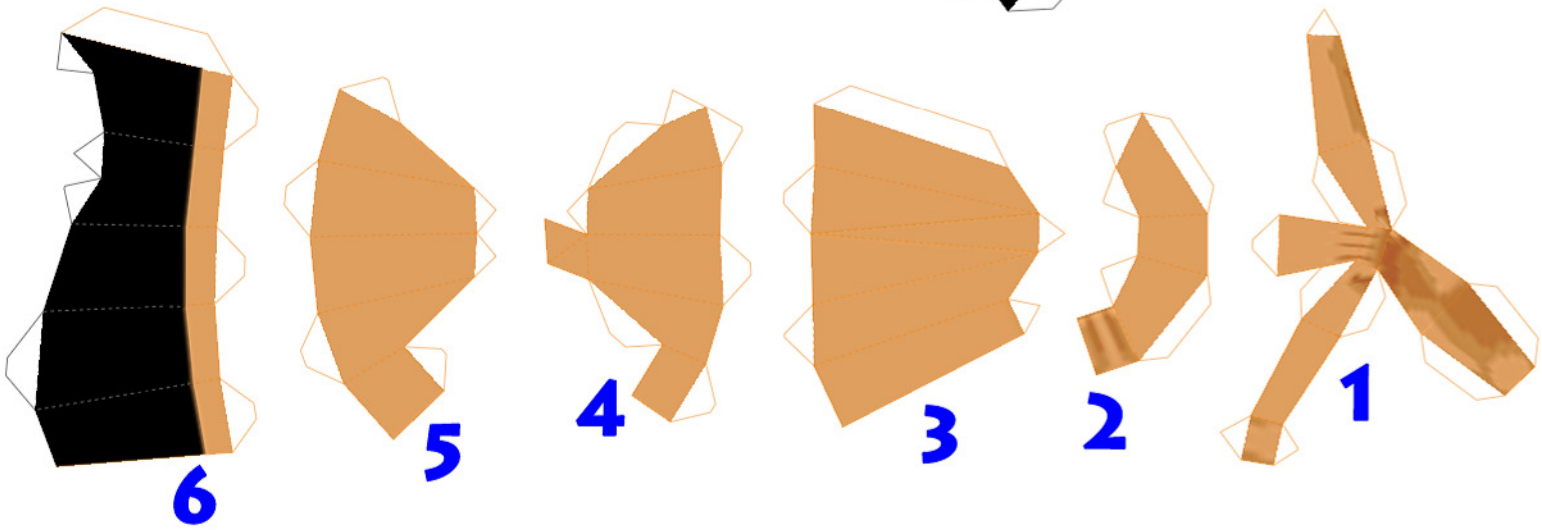
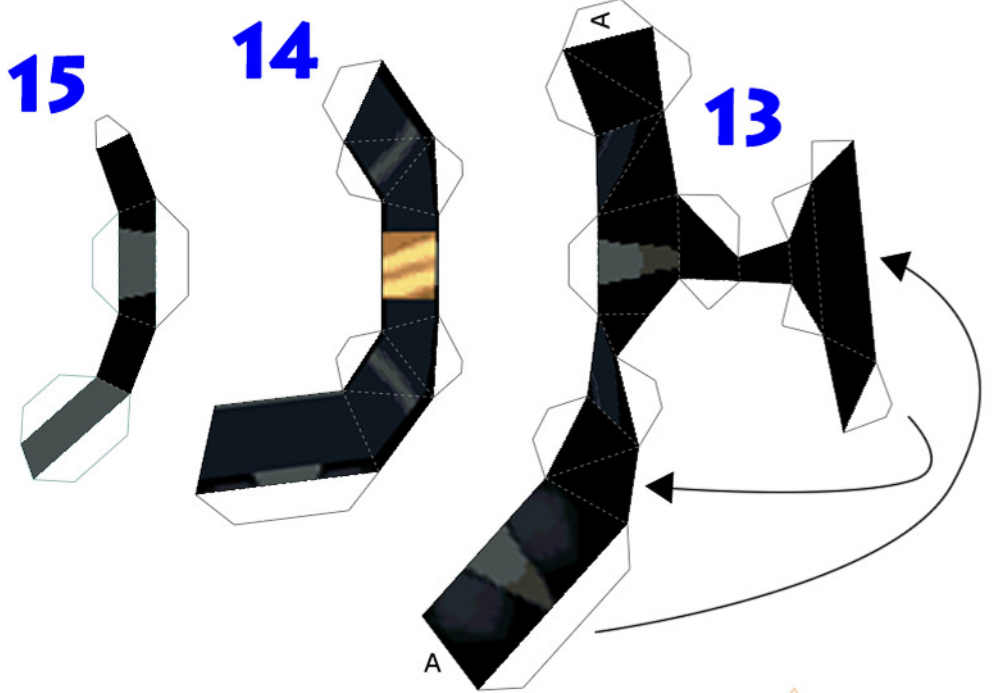

31

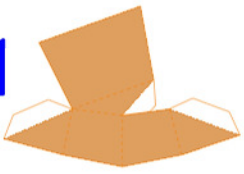

34

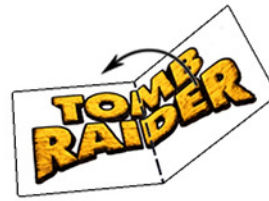
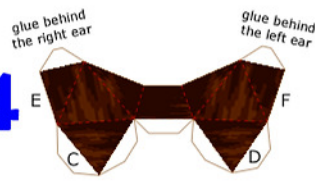

dot-dash lines:
fold up (valley fold)

30



36



dashed lines:
fold down (mountain fold)

29



35



28



33

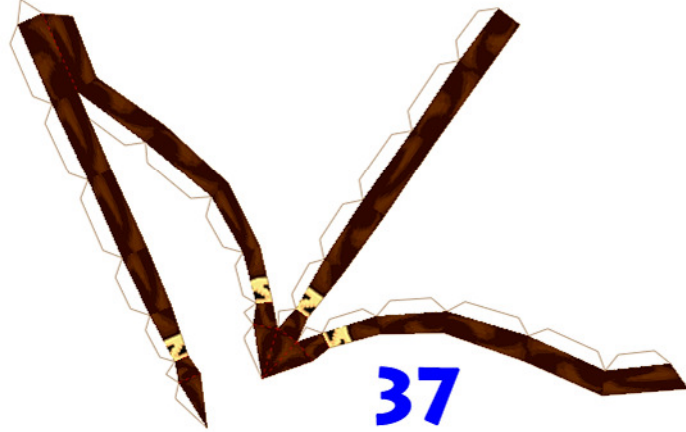
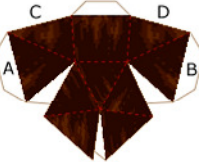

37

32

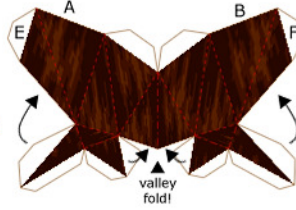

26



27



21

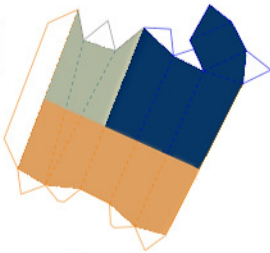

19

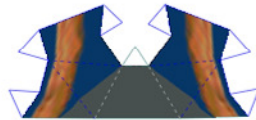

20

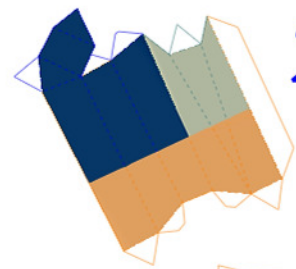
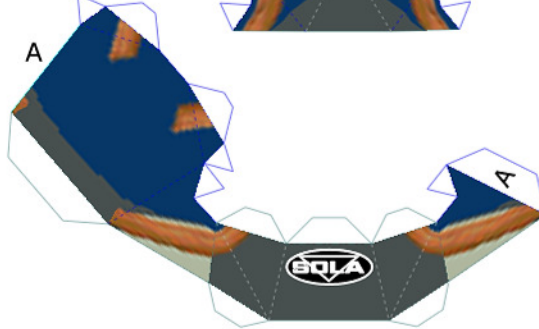

23

22

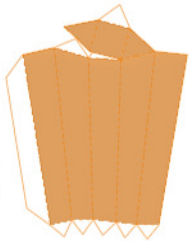

18

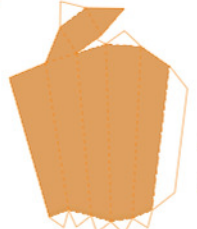

24

41



17

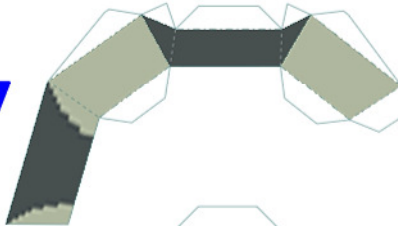

25

16

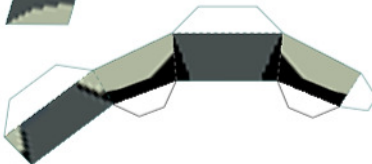

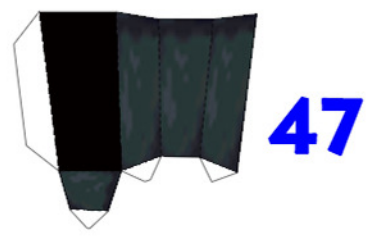
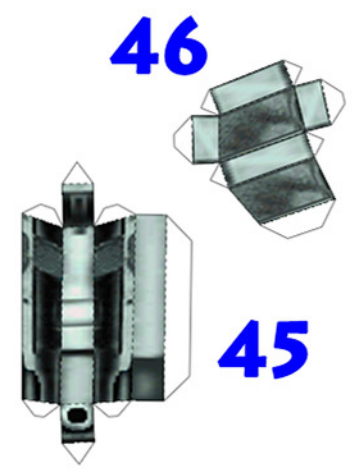
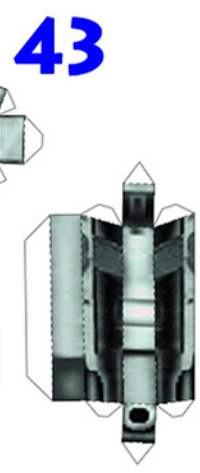
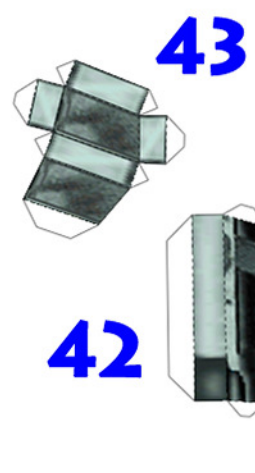
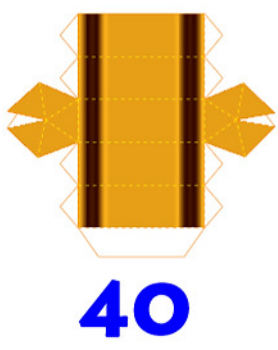
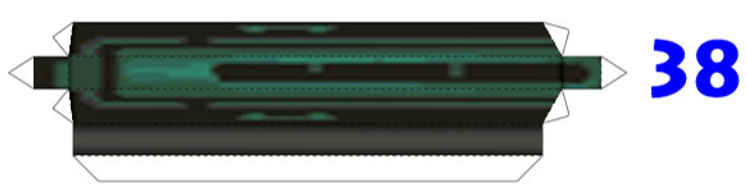

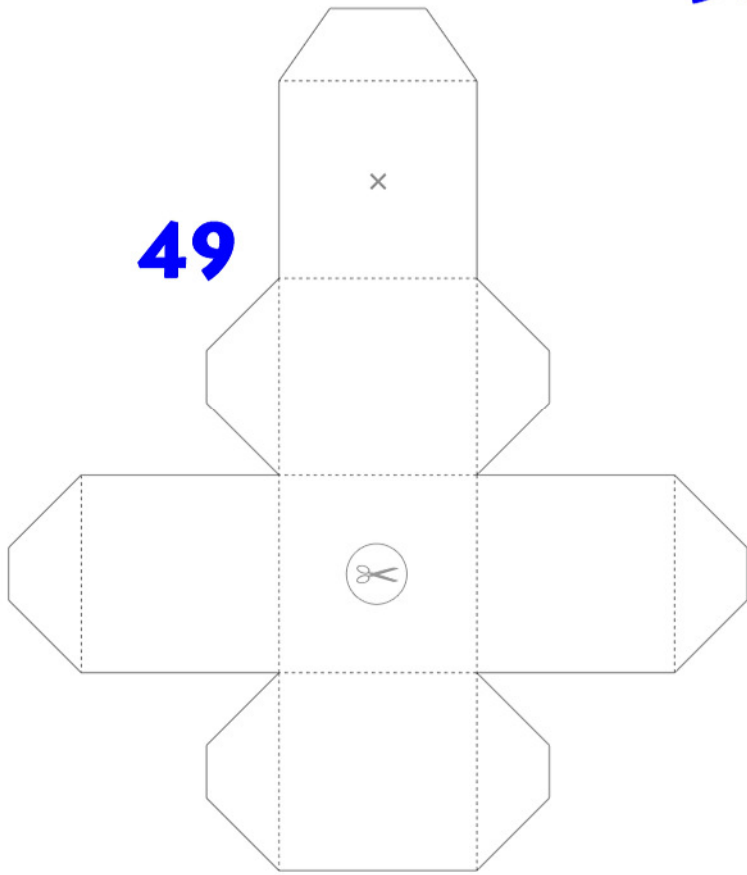

50

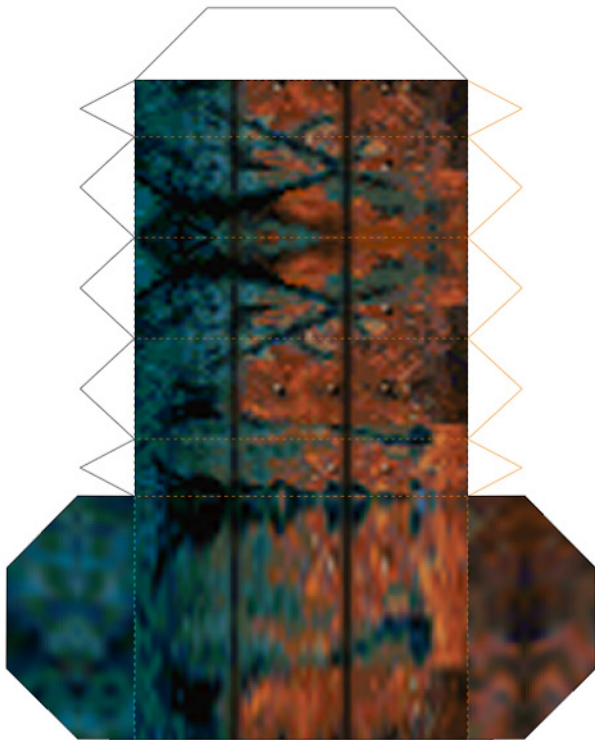
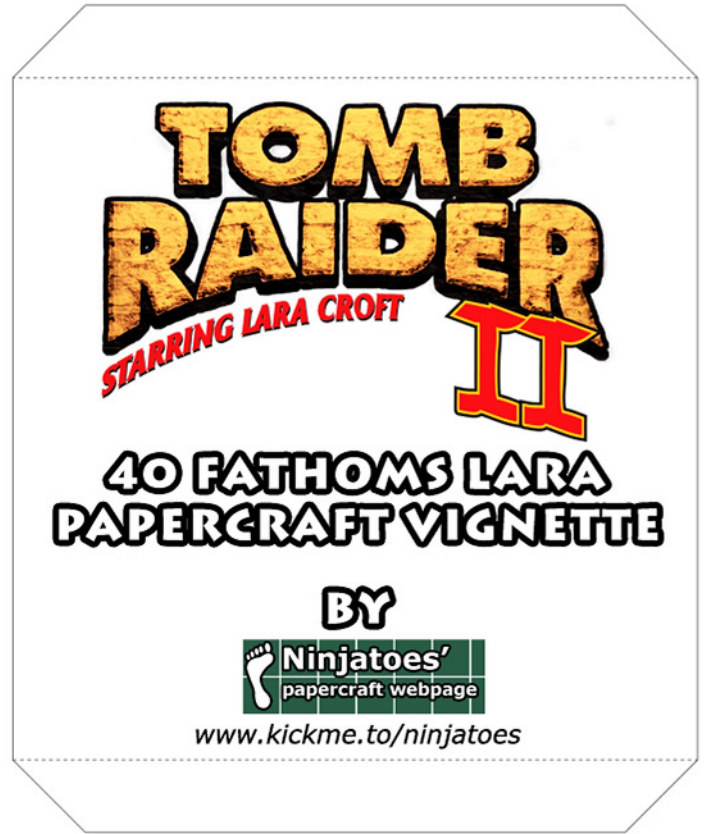

51

