

# N ONE

1/9 SIZE 展開図



製作するには、組立説明書をよく読んで、それぞれのパーツの組立に必要な工作方法に従って組立ててください。

## ■ 用意する道具・材料

### 【用紙】

ペーパークラフトには、適度に厚みのある用紙がおすすめです。  
A4の紙をご使用ください。

### 【インクジェットプリンタ】

ペーパークラフトの展開図を印刷します。

### 【ハサミ・カッターナイフ・定規・カッティングマット】

パーツを切り出すのに使用します。カッティングマットがない場合、雑誌や厚手のボール紙で代用が可能です。定規は金属製のものが理想です。

### 【鉄筆など先のとがったもの】

折り目をつけるために使用します。  
(インクの出なくなったボールペンなどでも代用できます)

### 【接着剤・面相筆】

パーツを接着するために使用します。木工用ボンドがお勧めです。木工用ボンドを水で溶き、面相筆などで塗りつけるときれいに貼ることができます。

### 【ピンセット】

細かいパーツを扱う時に便利です。

### 【百科事典や辞書など】

水平に圧着させるために「おもし」として使用します。

## ■ ワンポイントアドバイス

- シートから部品を切り取る前に折線すべてに筋入れをしてください。
- 切り取った部品の裏側に部品番号を書くようにすることをお勧めします。
- 接着剤をつけすぎると、紙にしわがでる場合がありますので適量をご使用ください。
- 切断面が白く目立つ場合はサインペンや色鉛筆、アクリル絵の具などで着色するときれいに仕上がります。
- パーツを円柱や円錐にする場合には、ボールペンのような円柱形の棒に巻き付けるときれいに仕上がります。

## ■ ご注意

- ハサミ、カッターナイフなど刃物の取扱いには十分にご注意ください。
- 接着剤等を使用する際は、室内の換気を十分におこなってください。

## ■ 組立説明書に出てくる記号

01 02 03 …… パーツ番号です

----- 山折り線      -.-.-.-.- 谷折り線

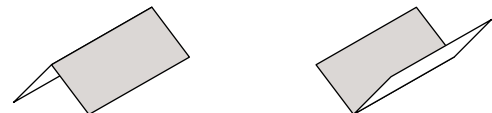

★ 切り抜いて取り外します

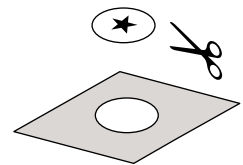

● のりしろです

◎ パーツ同士の接着面です

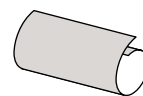
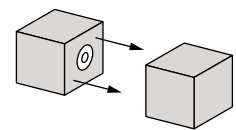
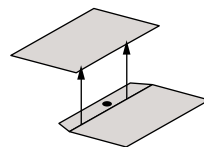

重ね巻き

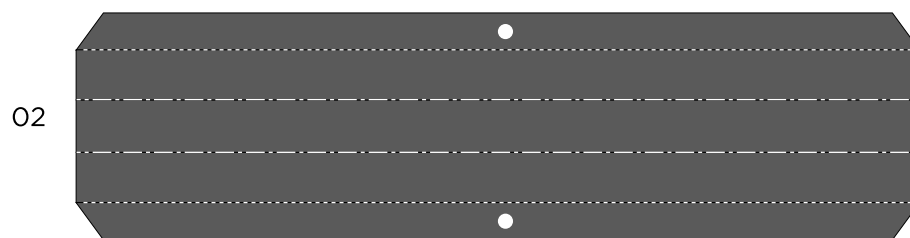
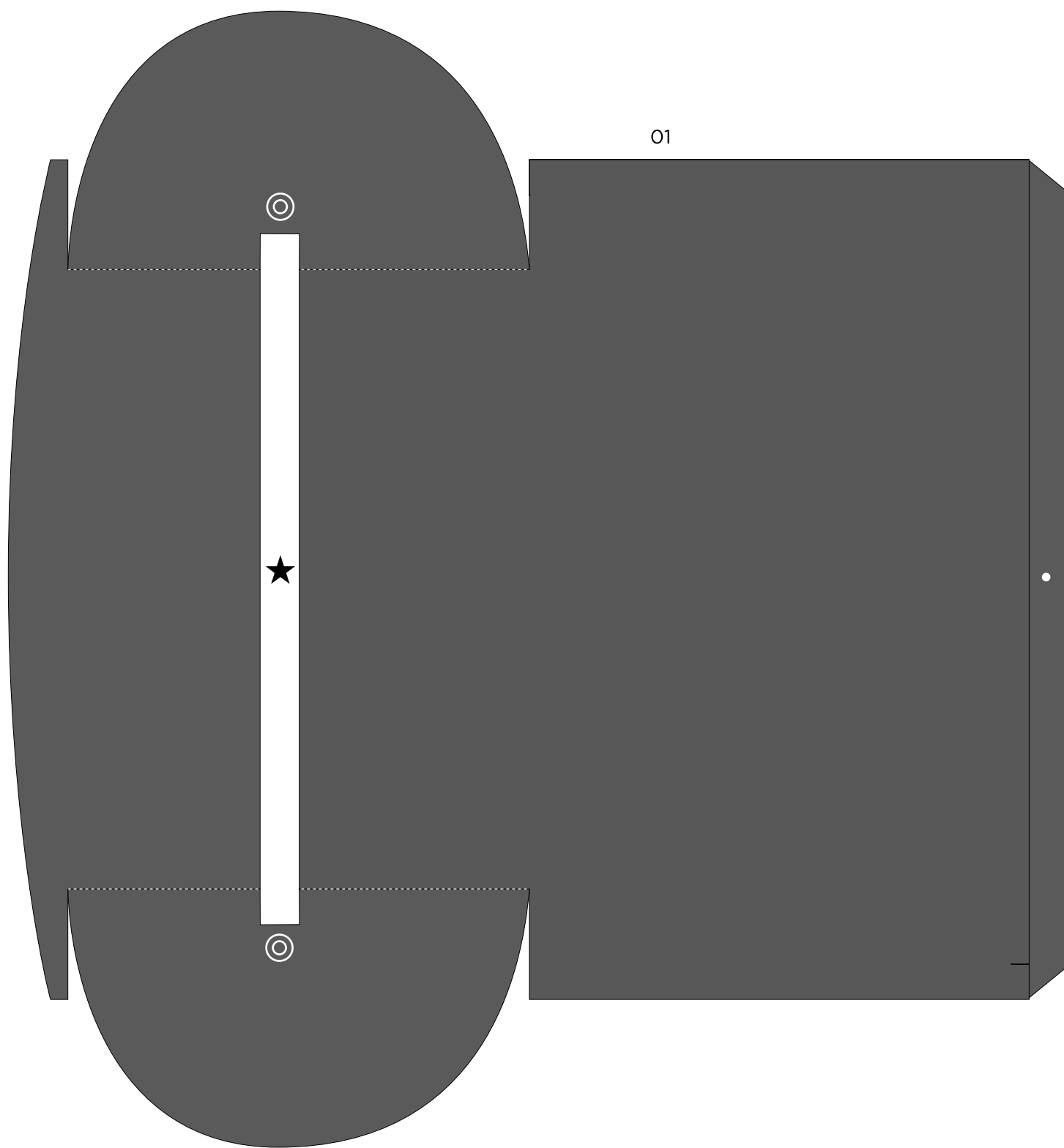

03

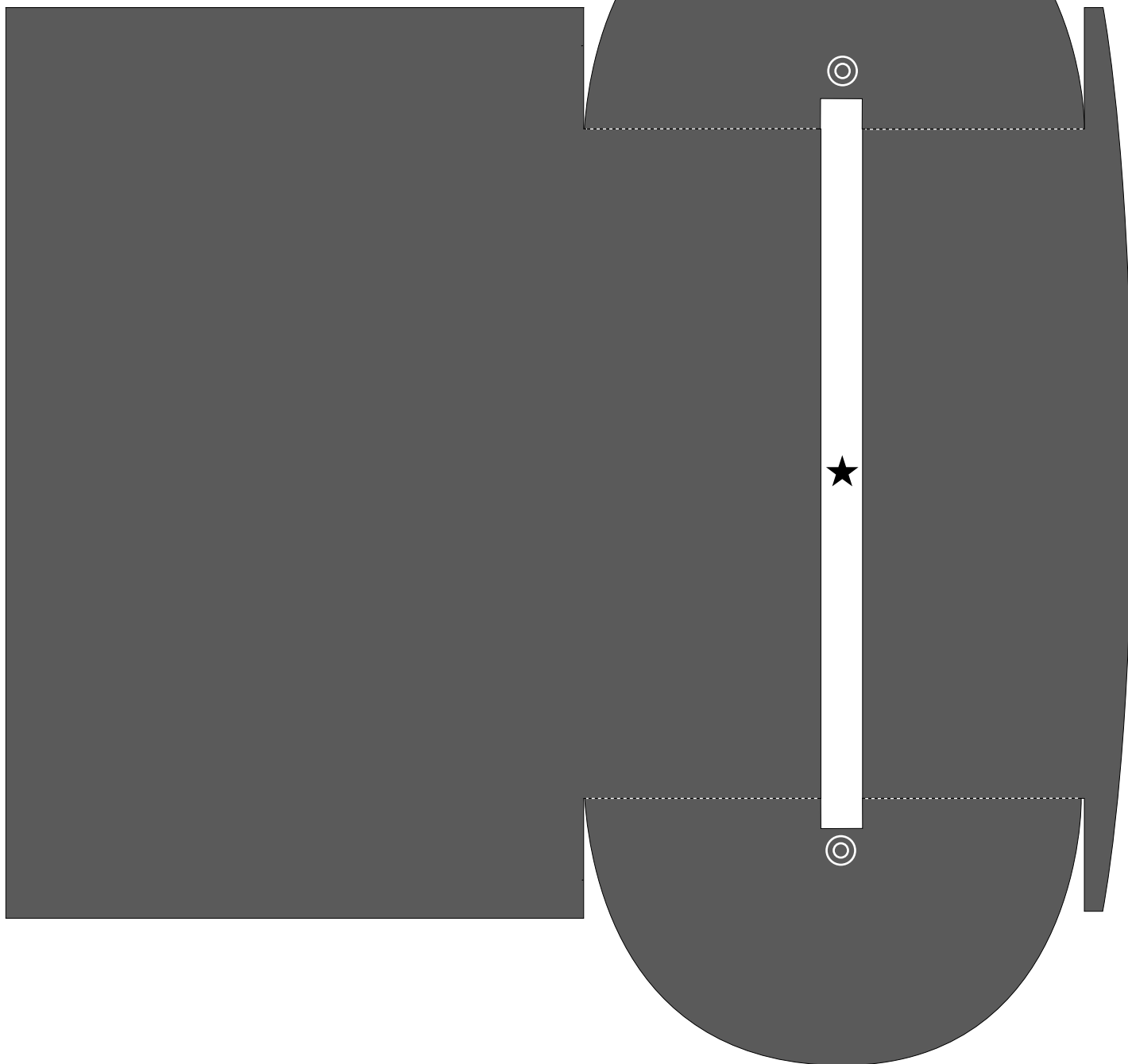

04

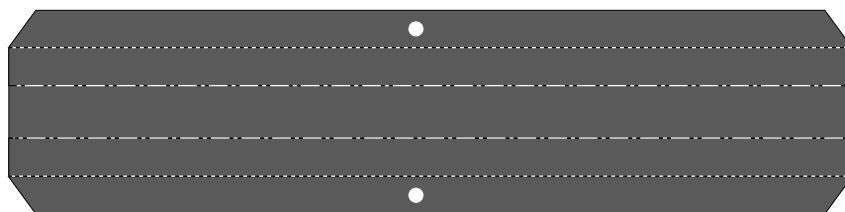

05



07

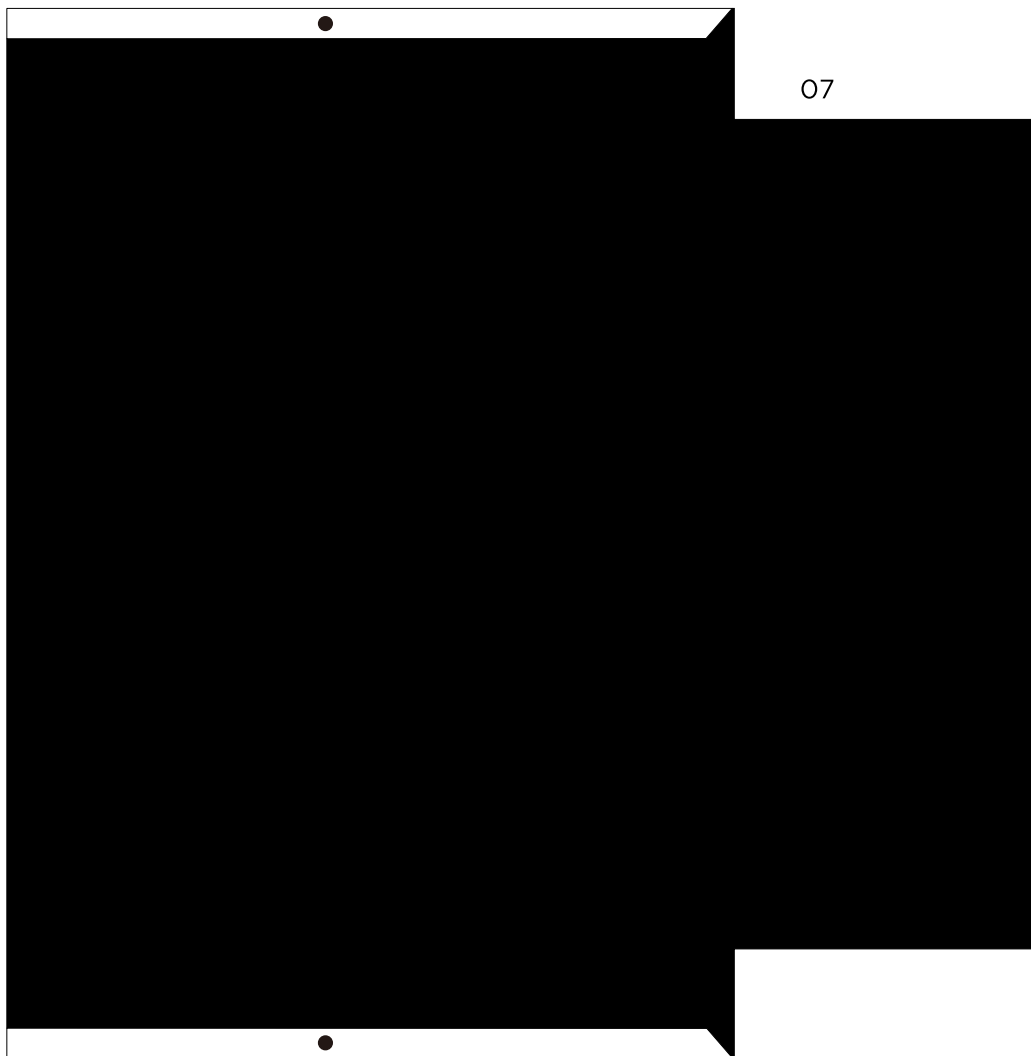

06

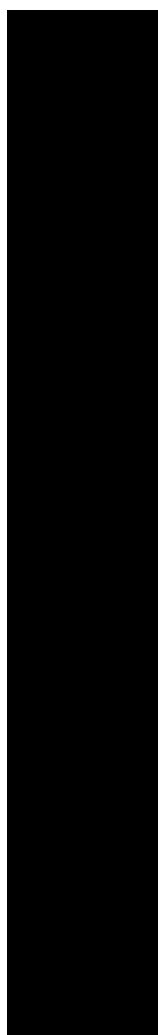

08

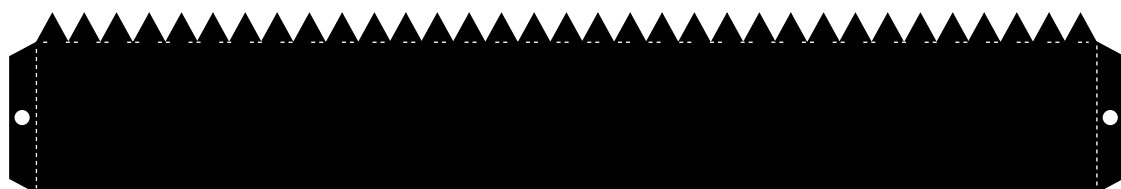

09



10



11

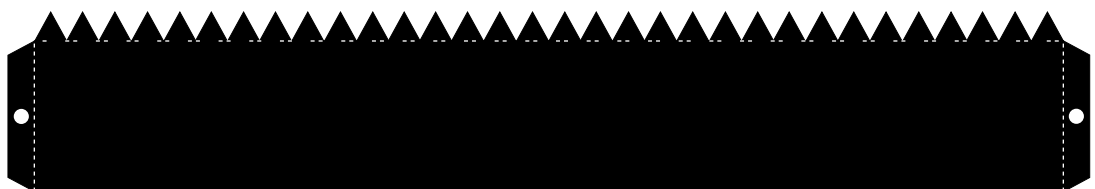

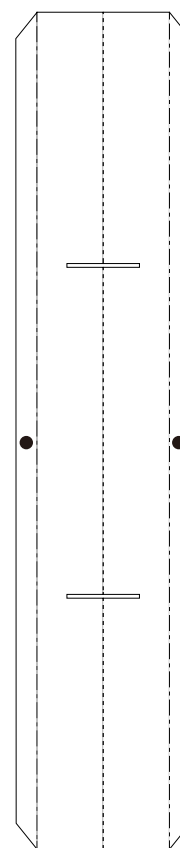
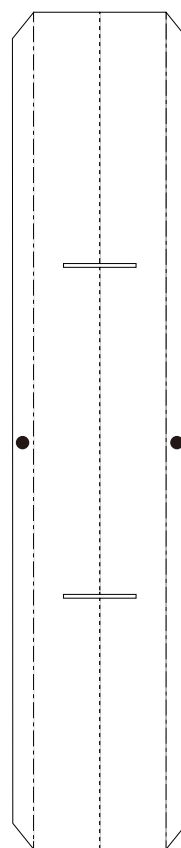
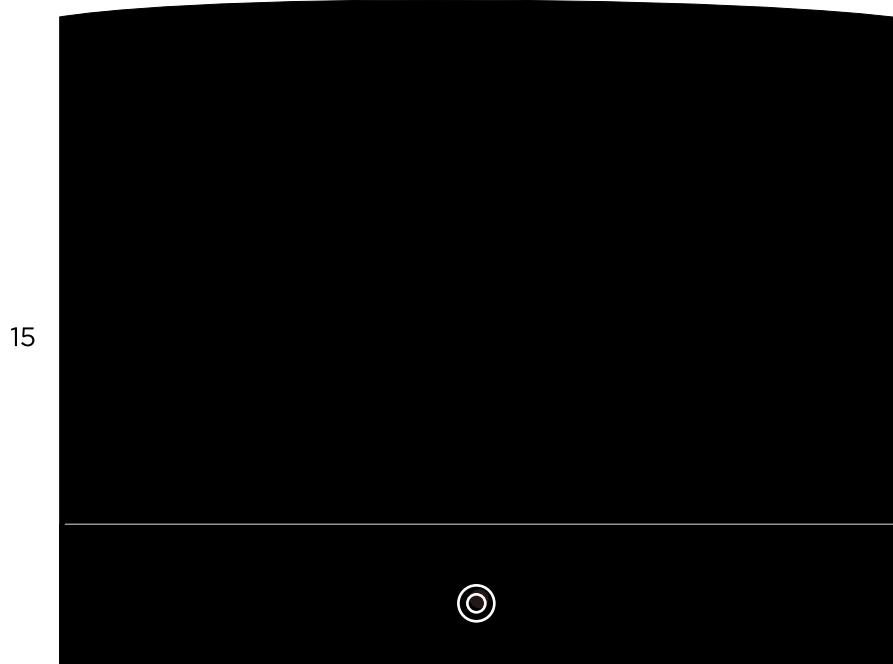
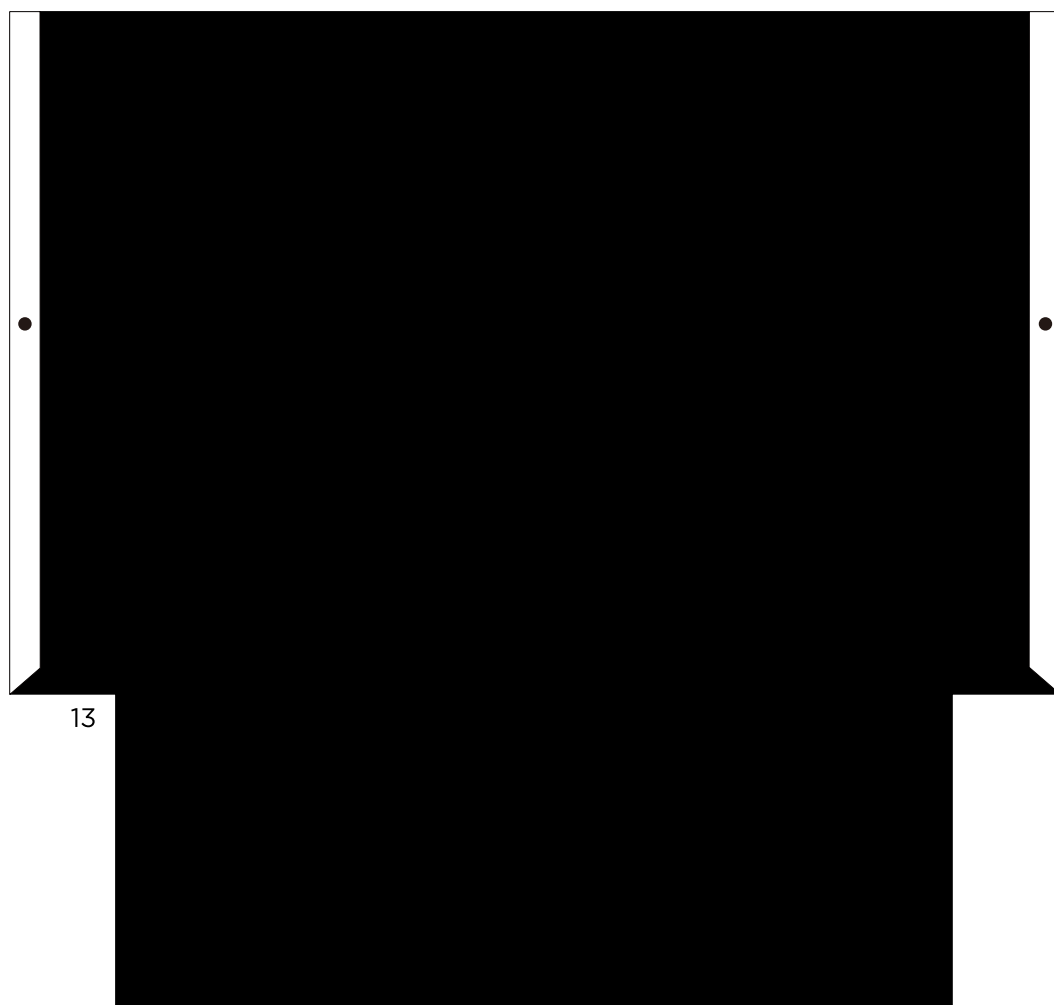
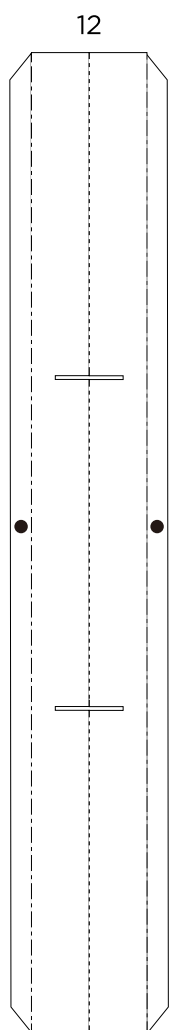

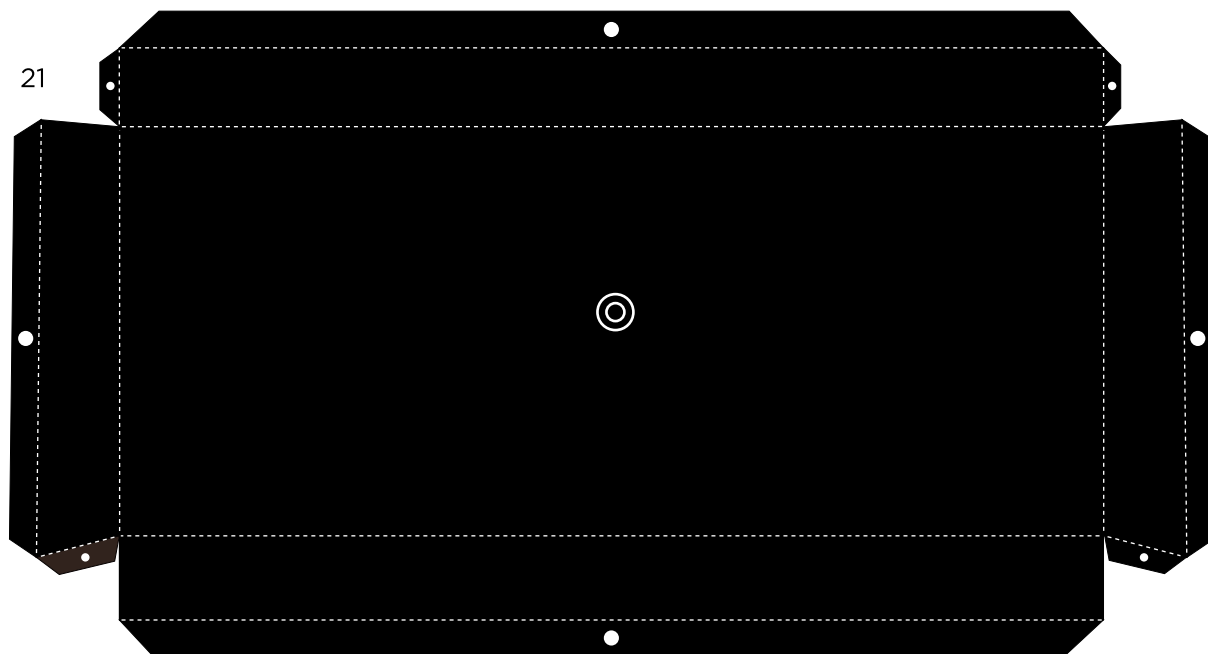
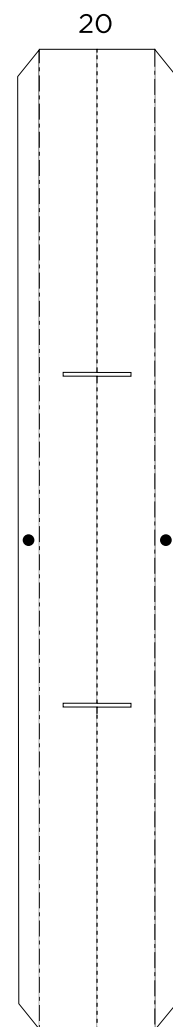
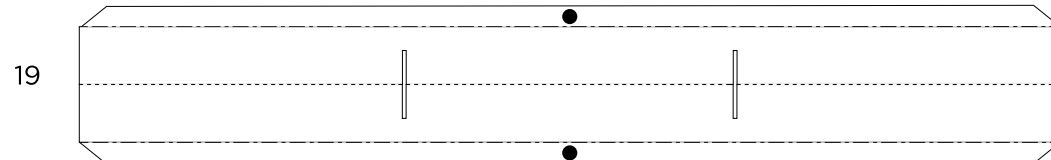
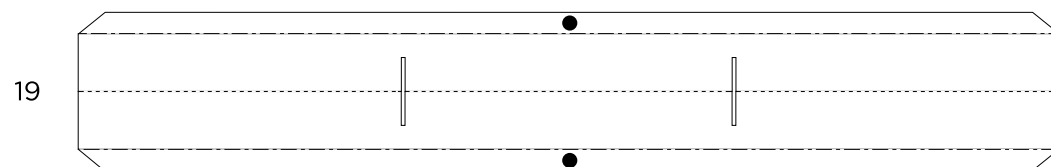
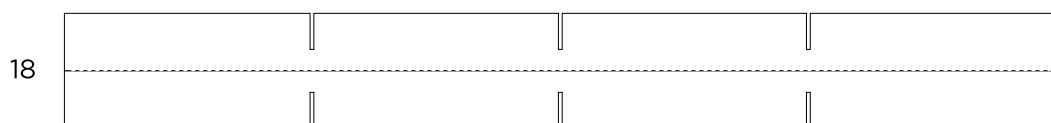
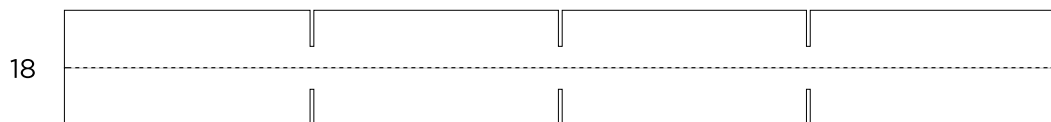
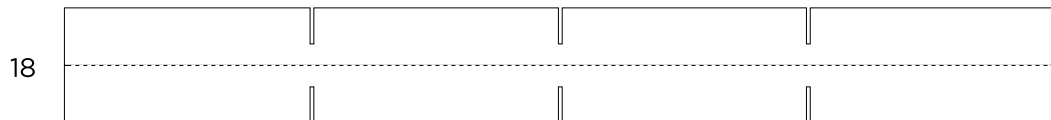
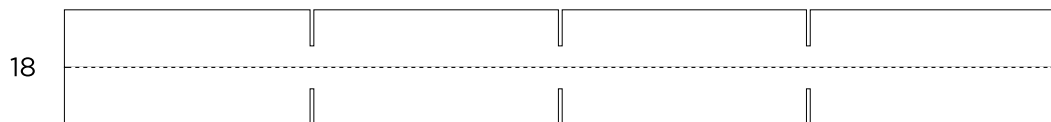

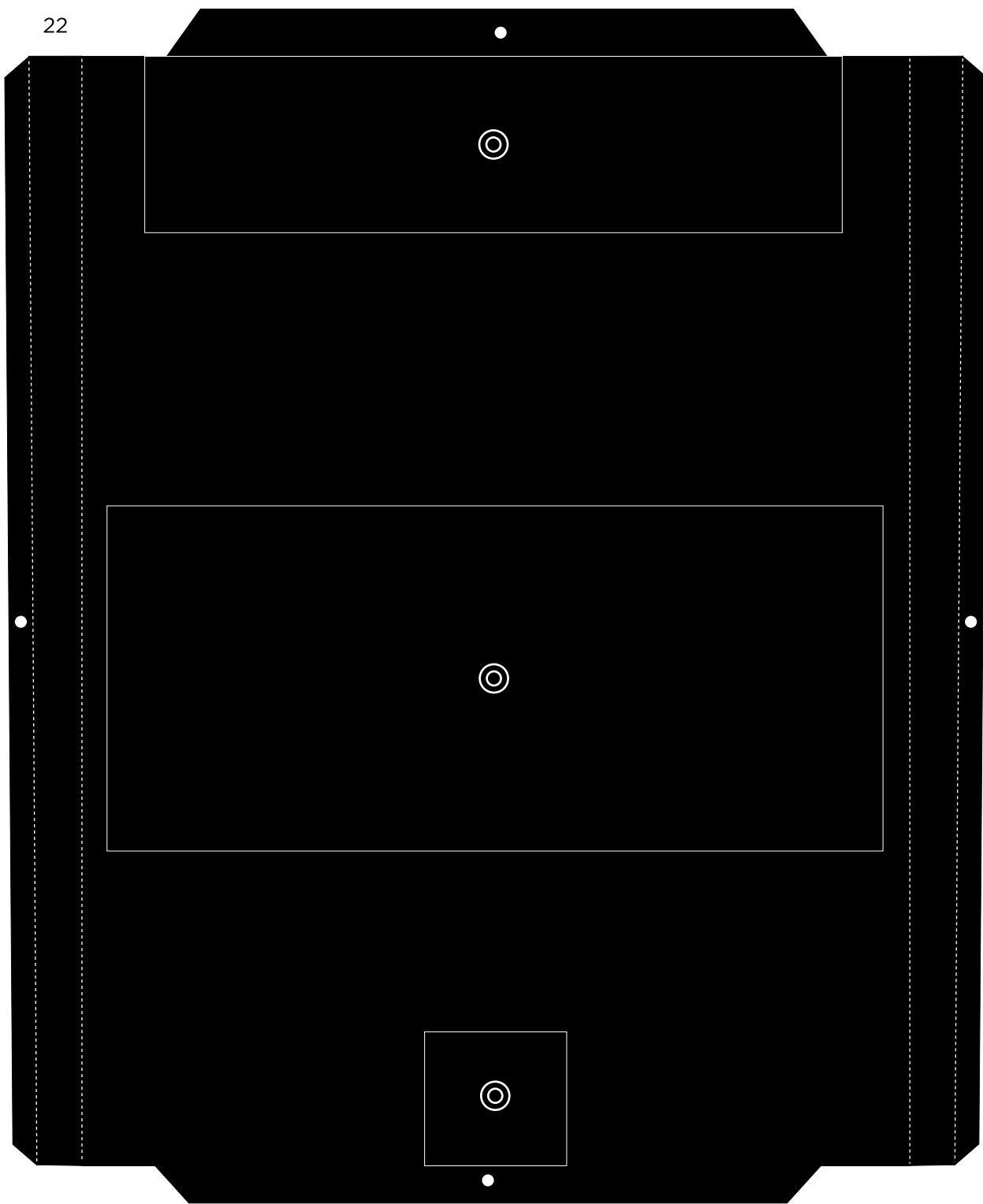

23

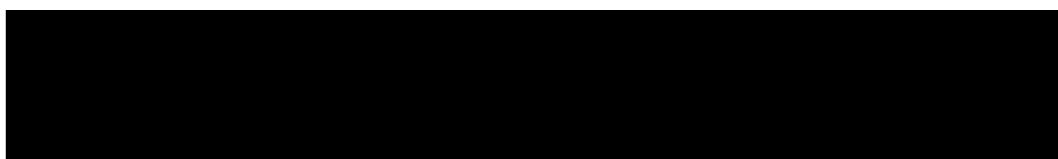

24





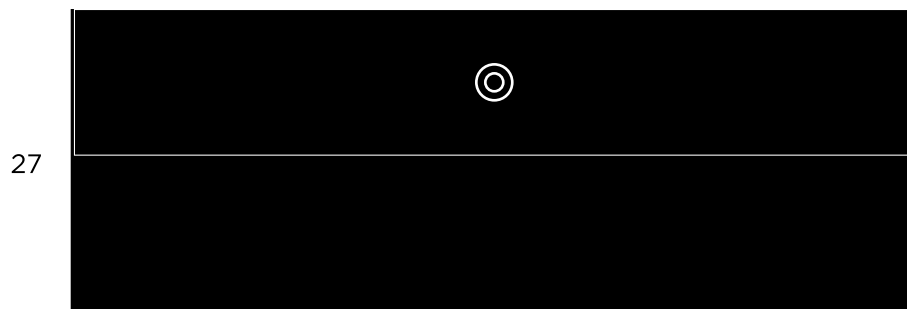
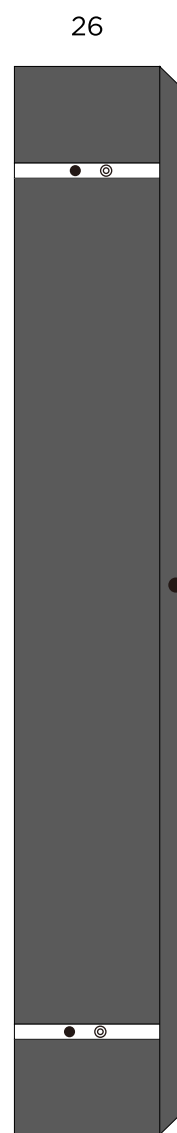
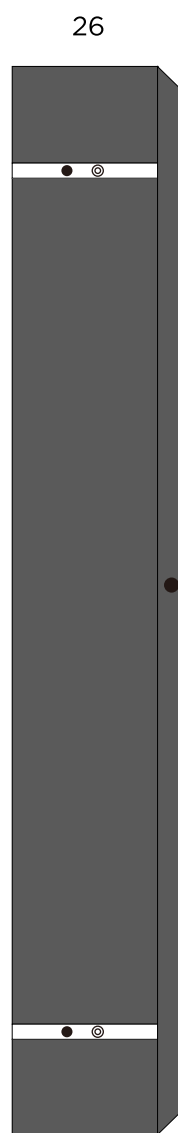
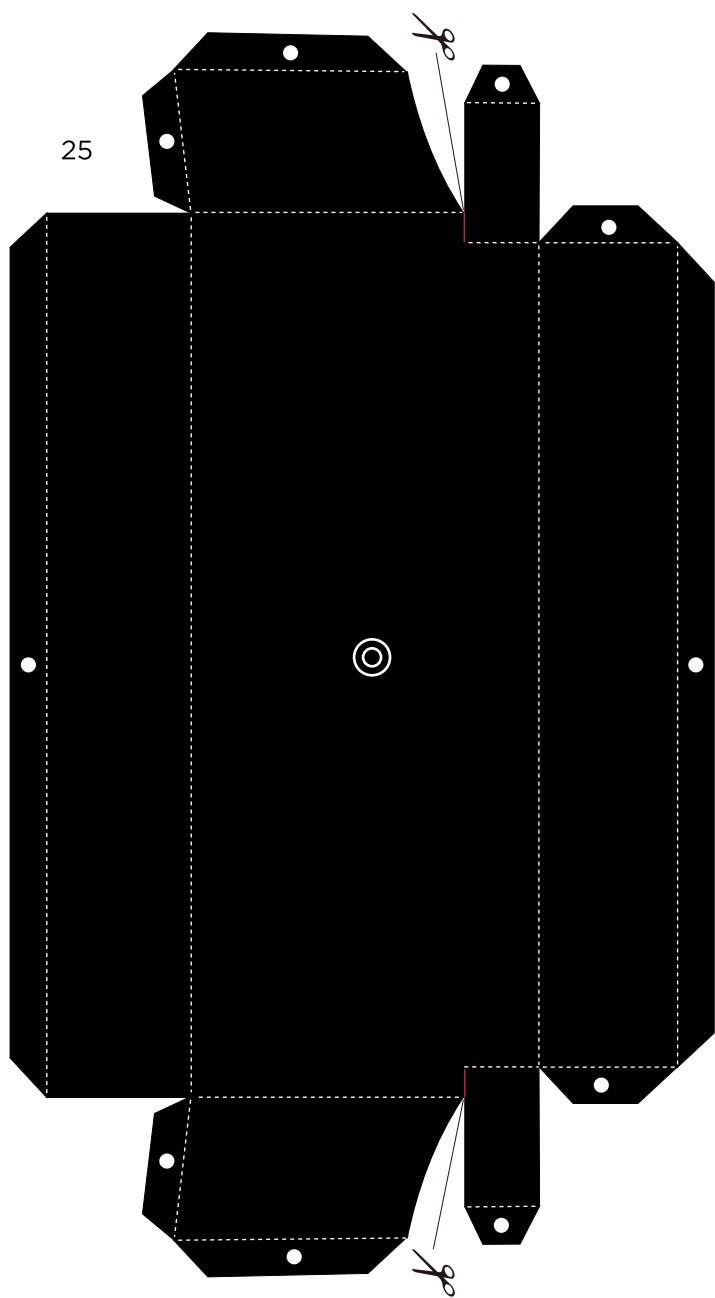

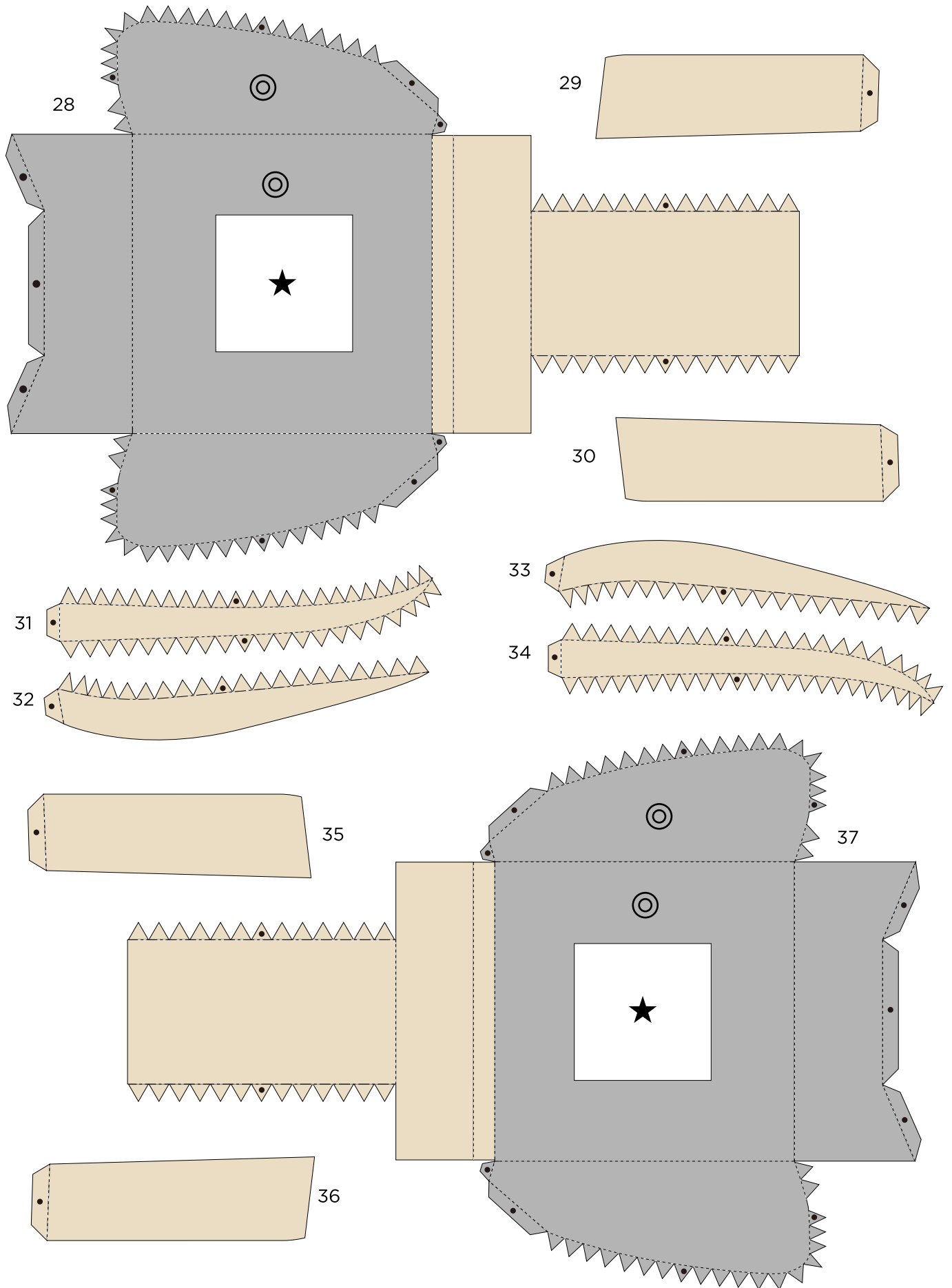

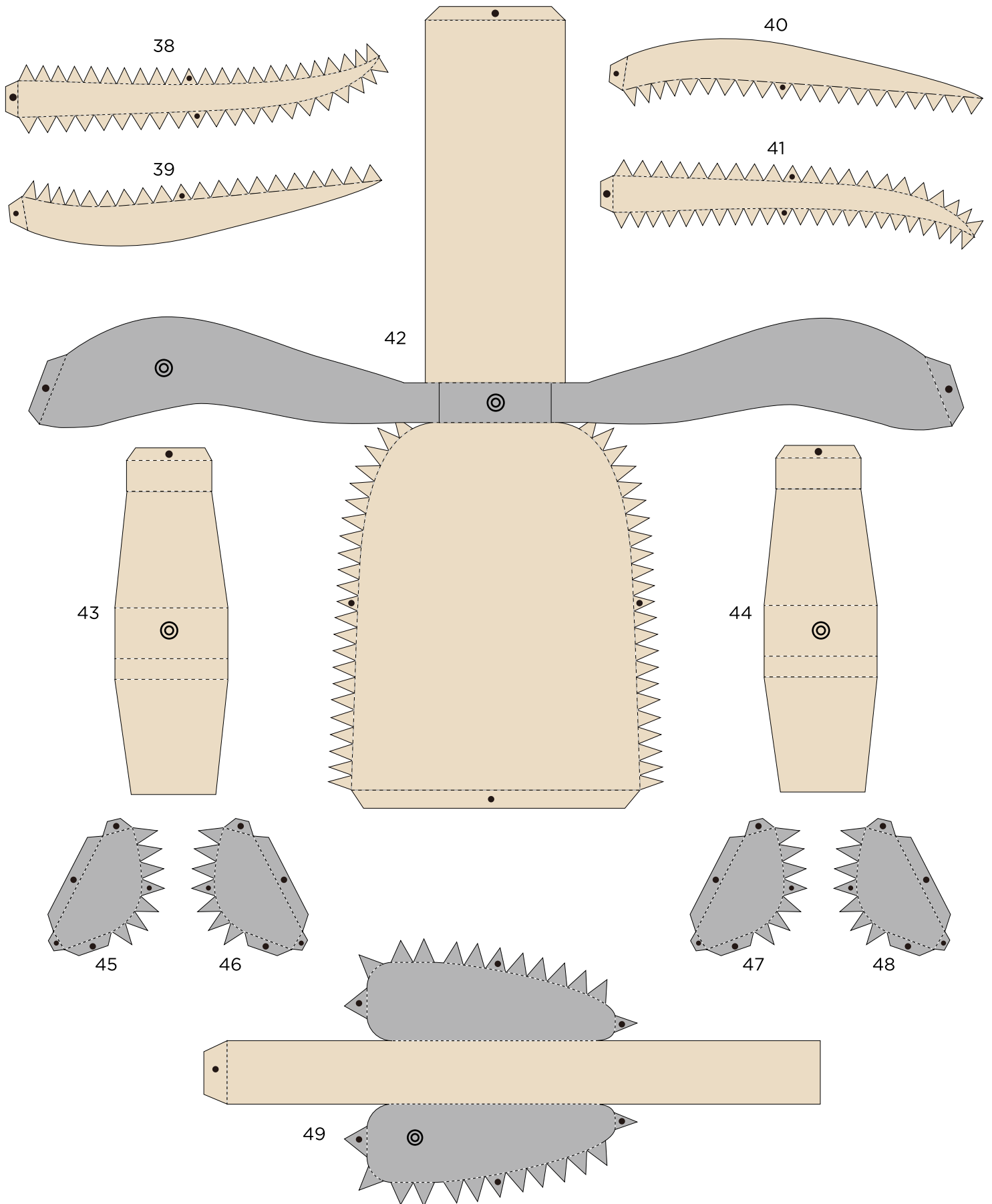

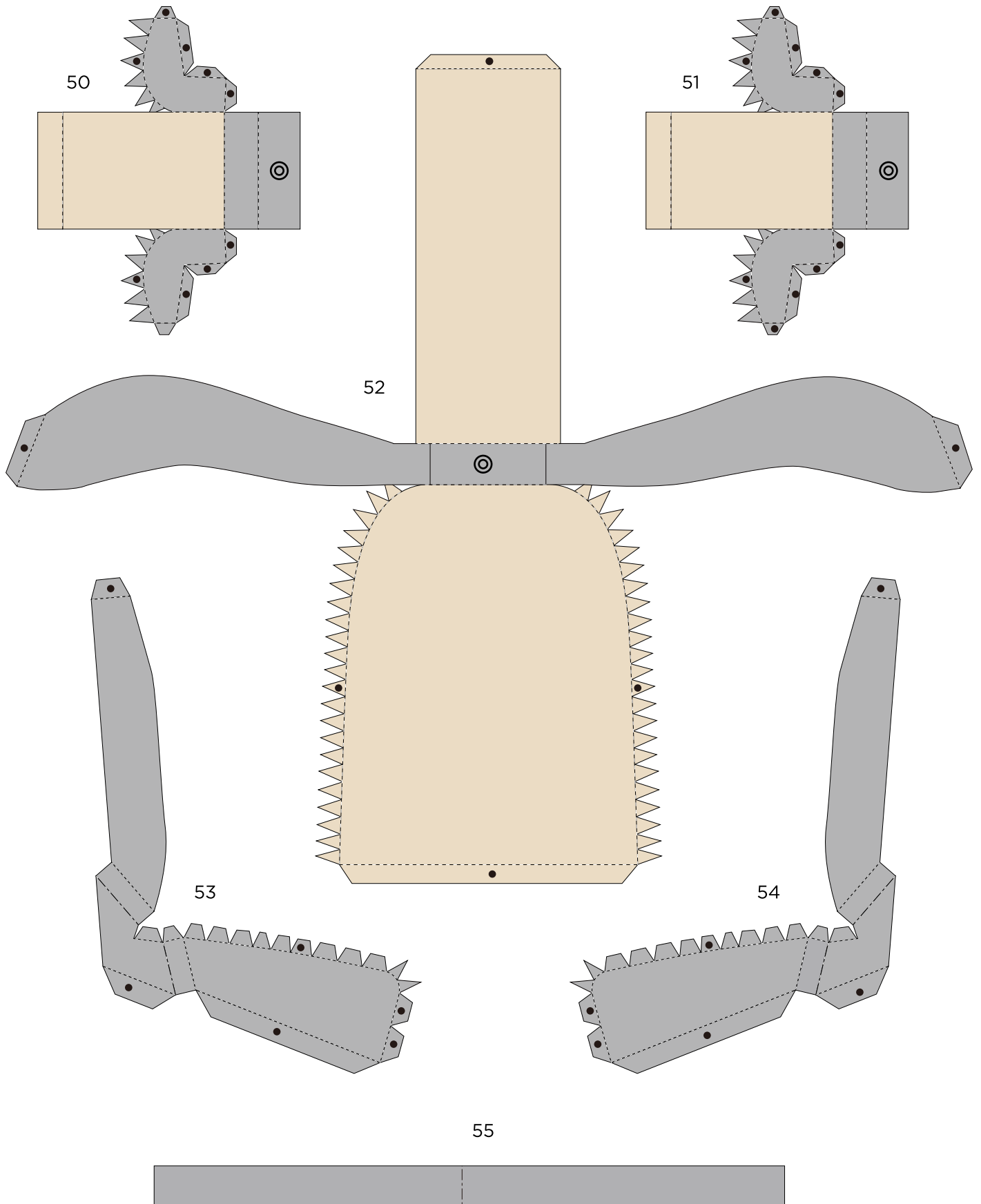

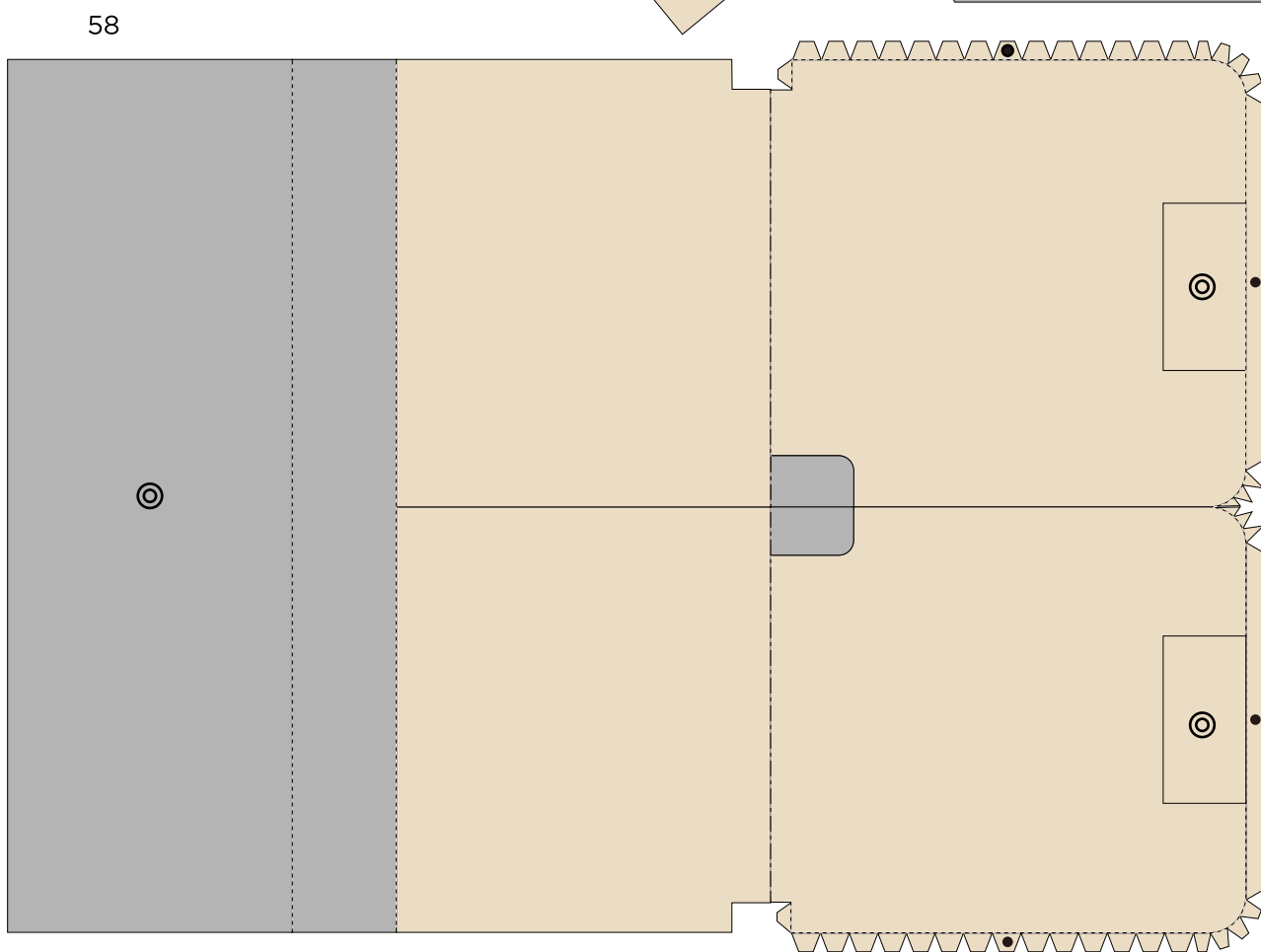
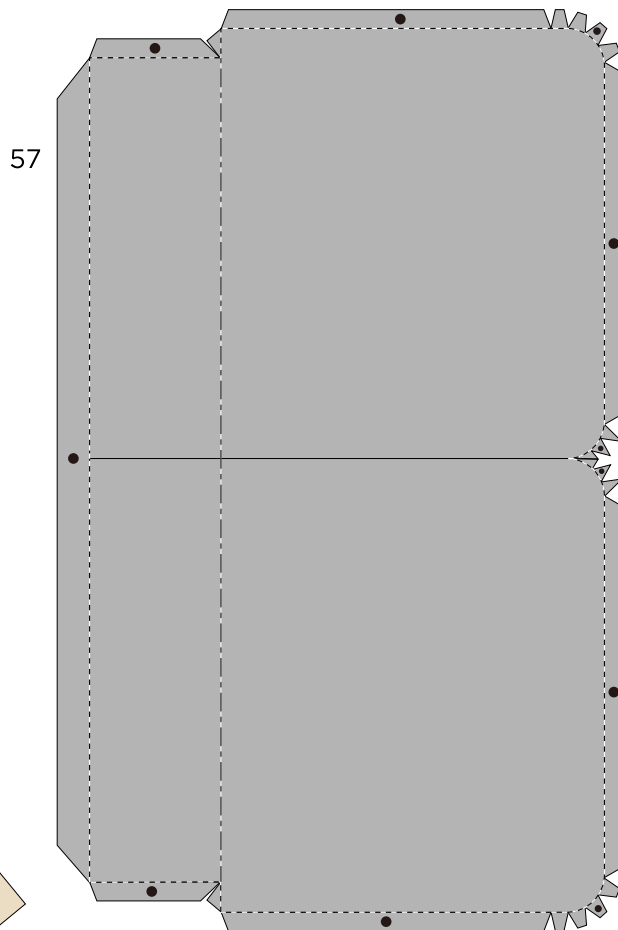
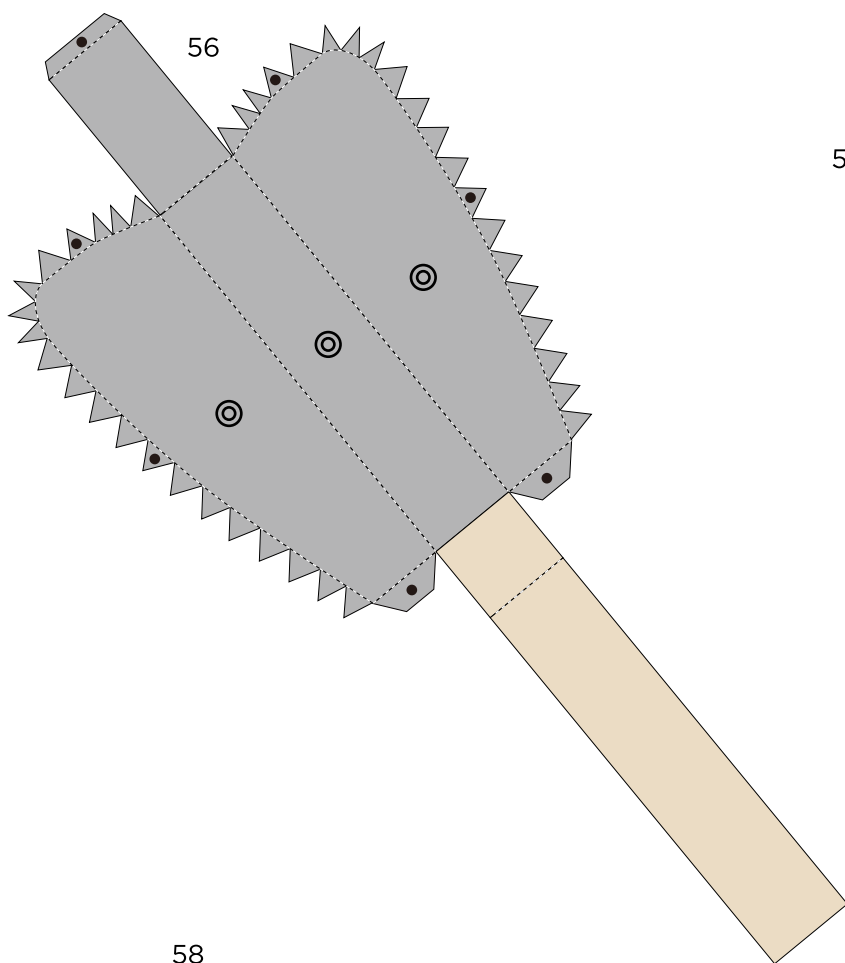

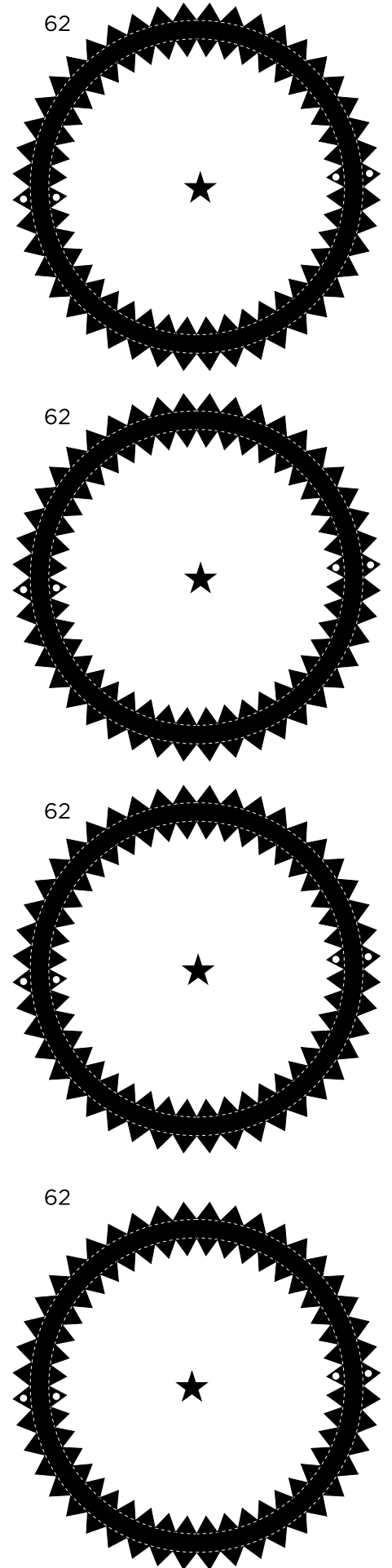
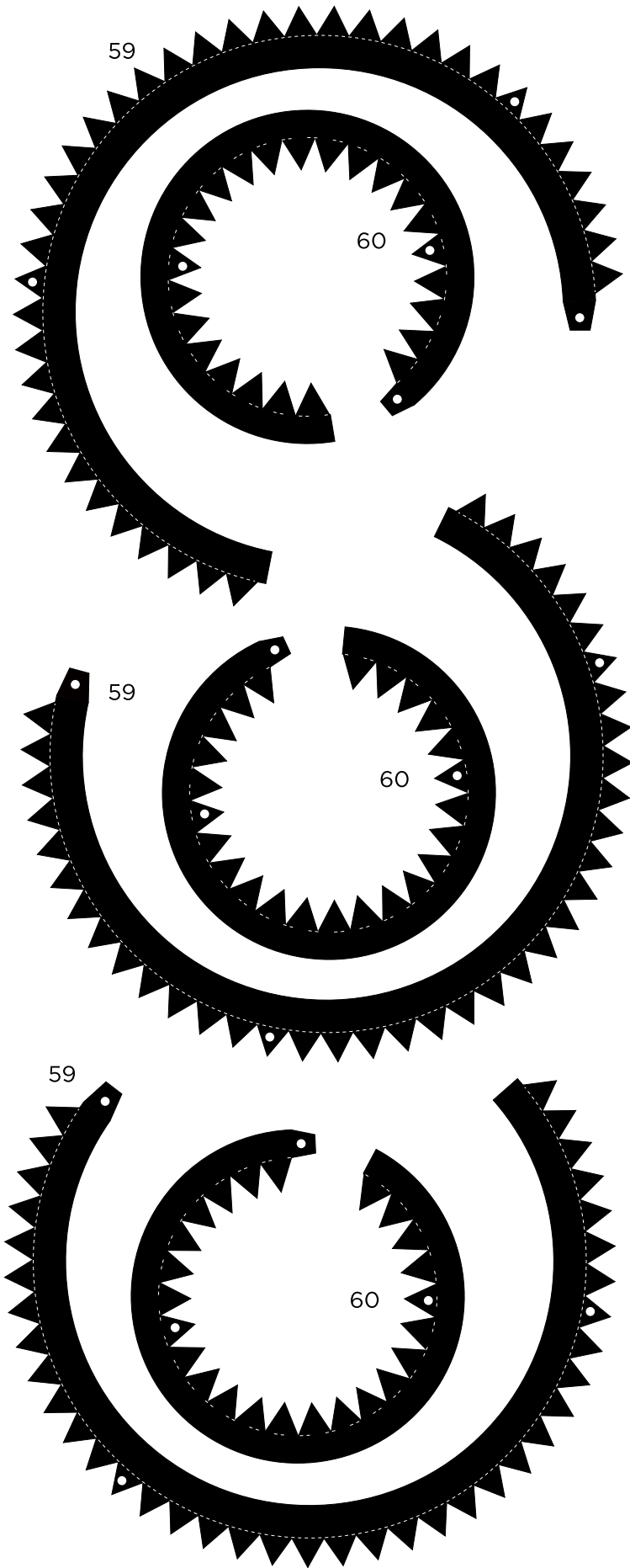

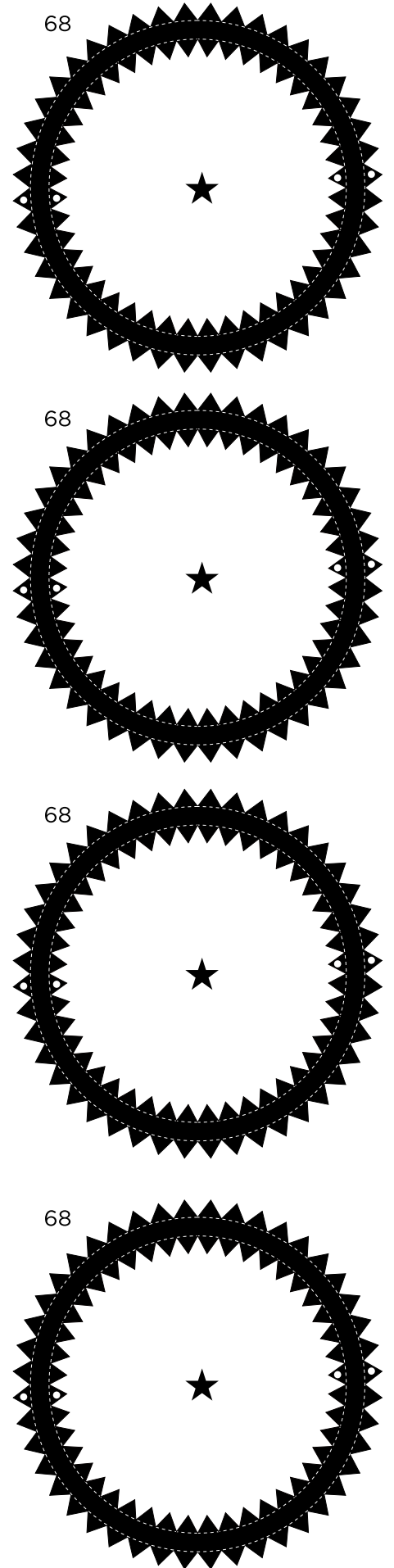
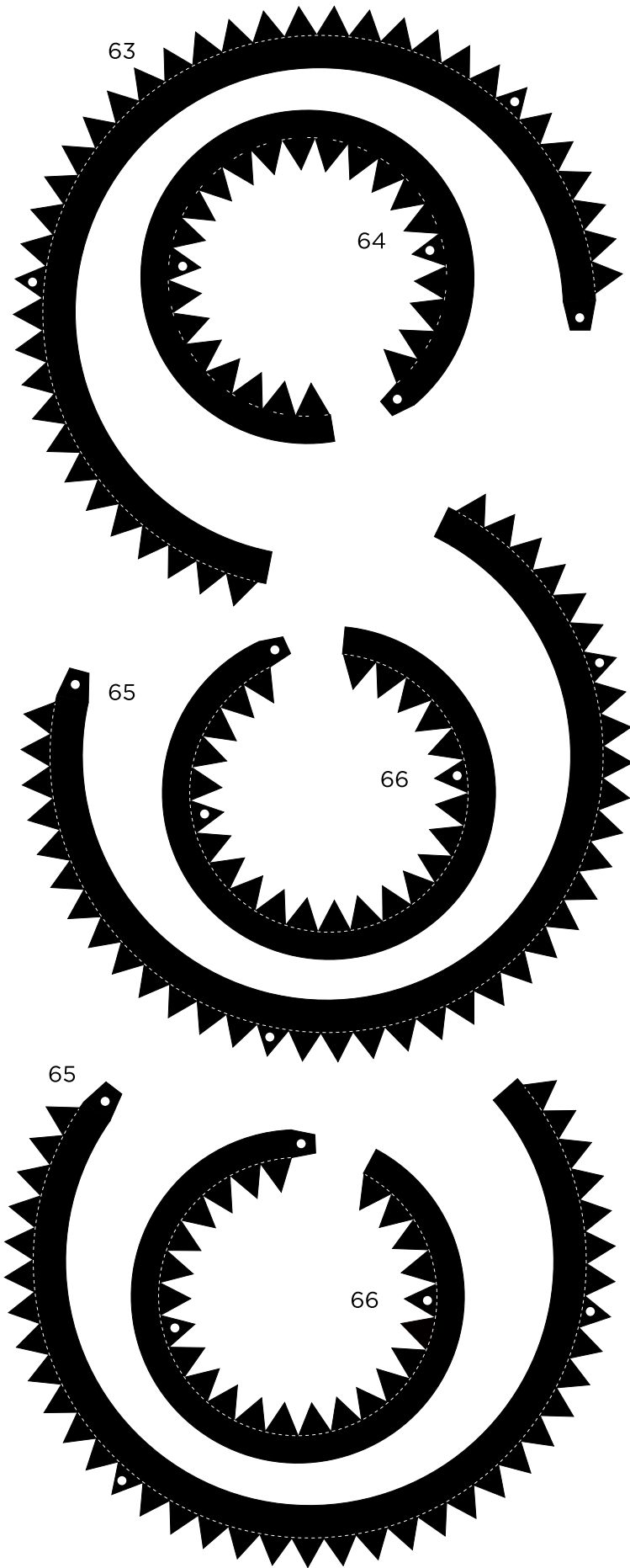

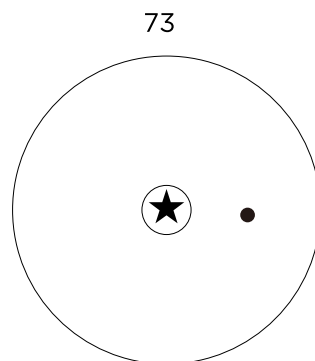
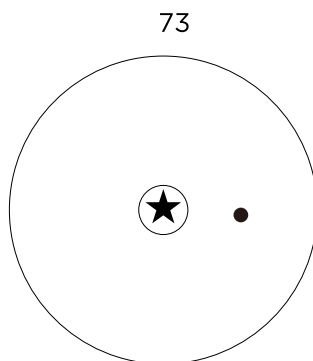
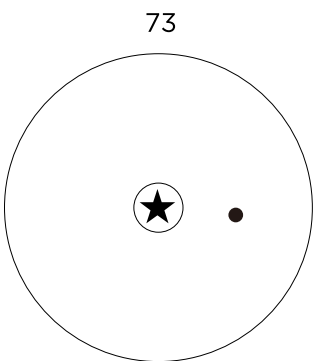
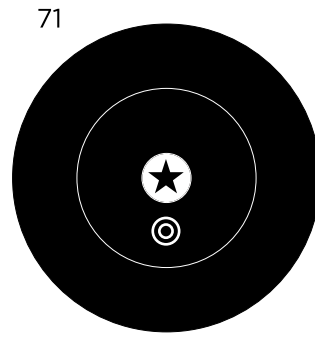
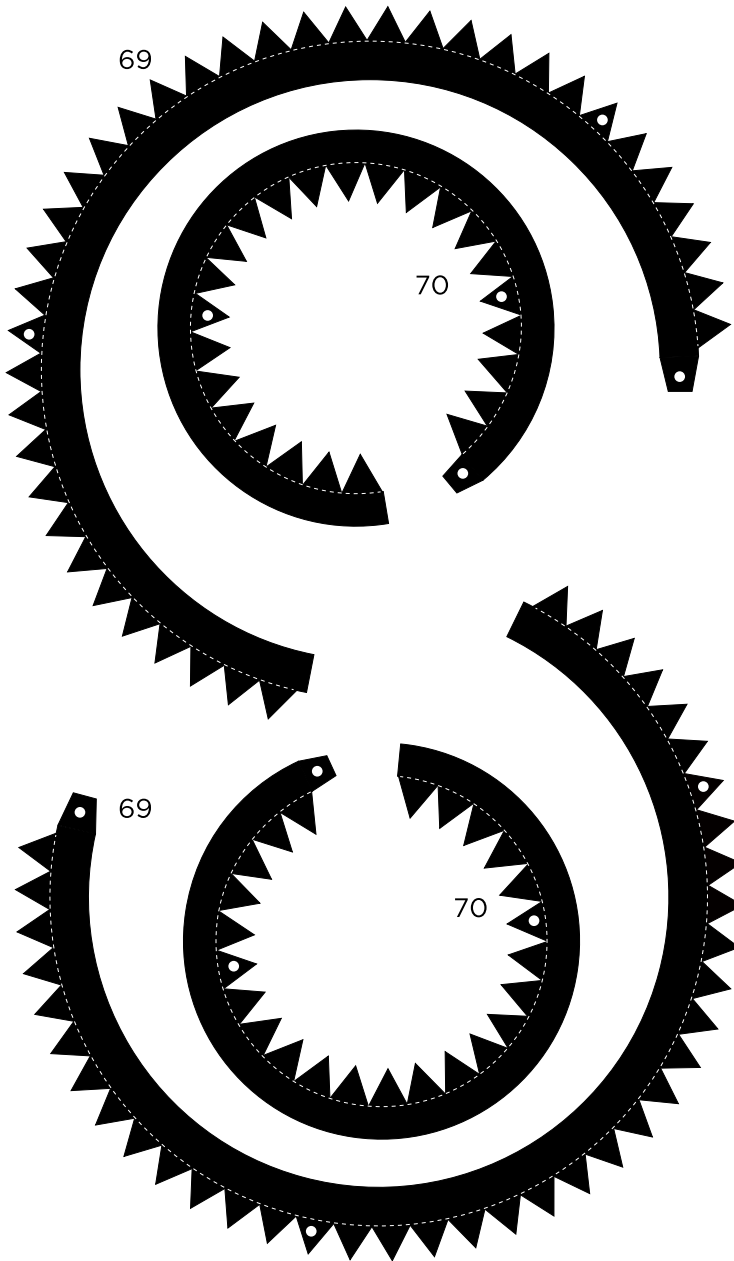



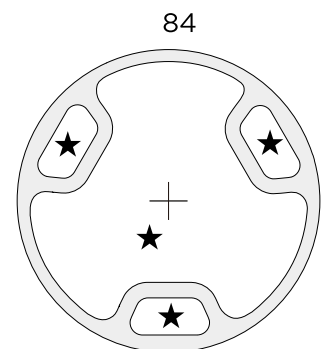
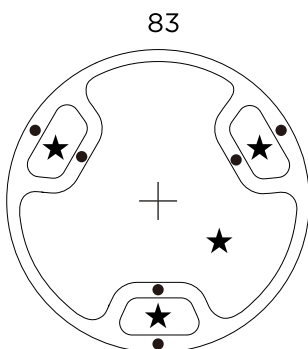
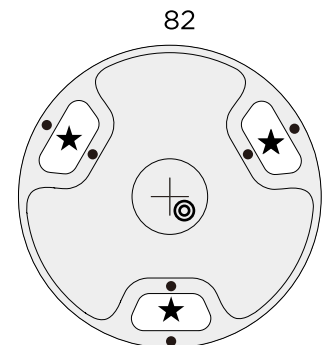
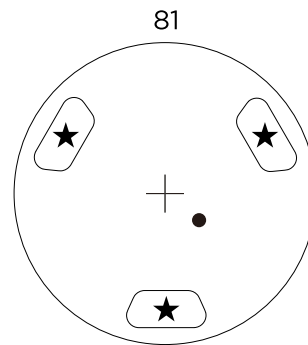
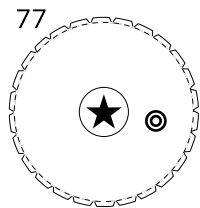
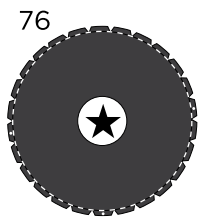
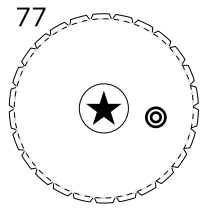
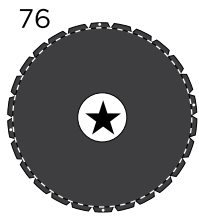
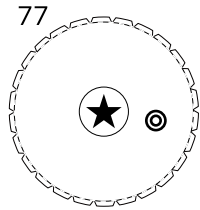
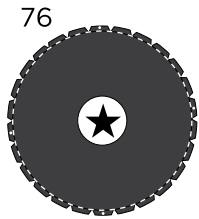
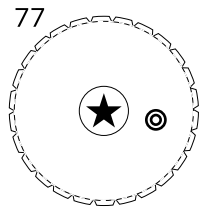
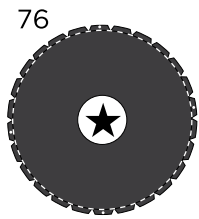
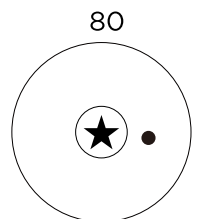
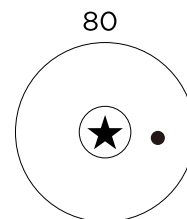
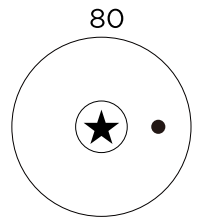
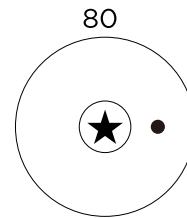
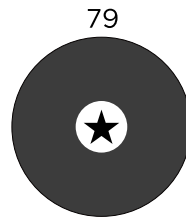
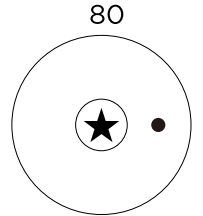
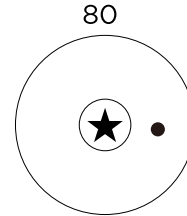
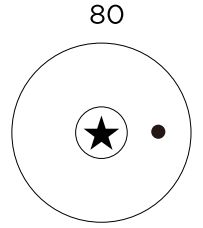
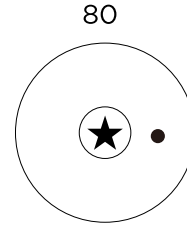
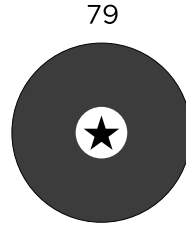
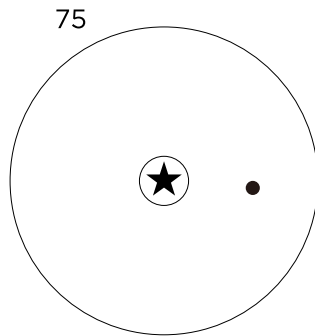
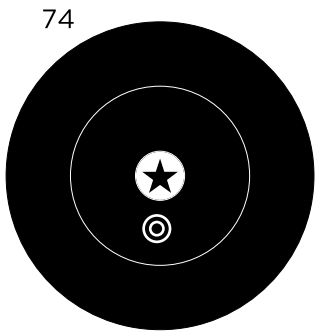

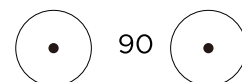
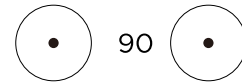
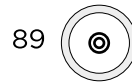
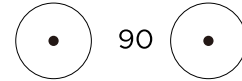
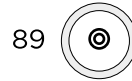
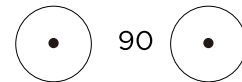
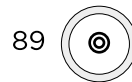
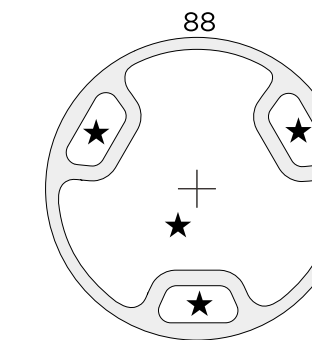
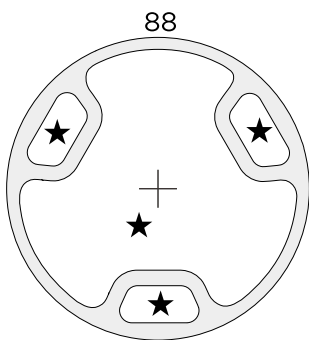
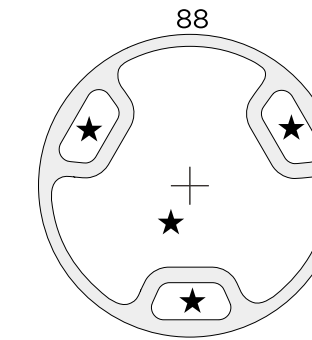
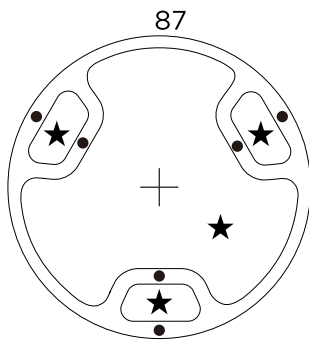
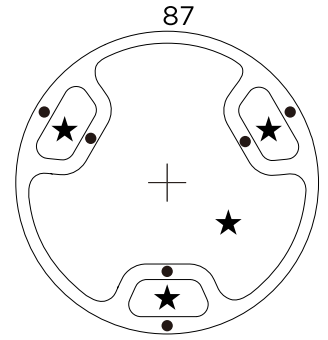
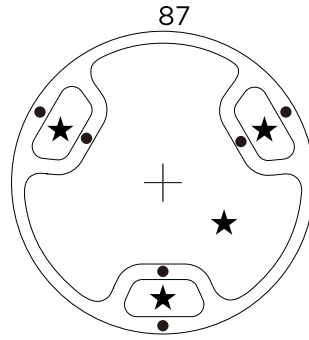
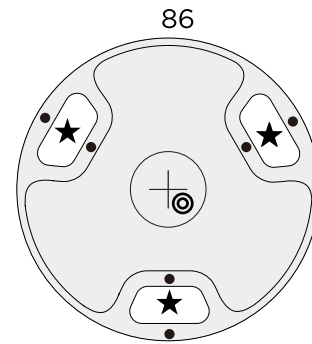
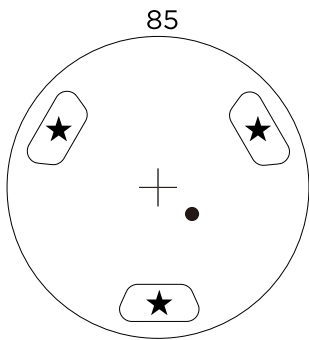
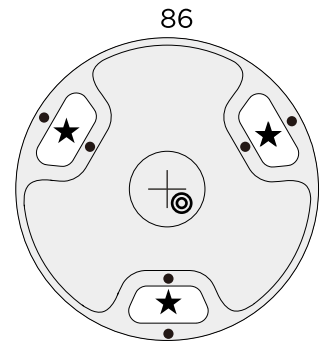
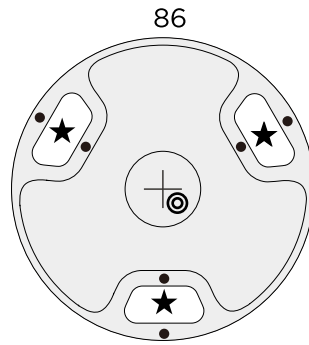
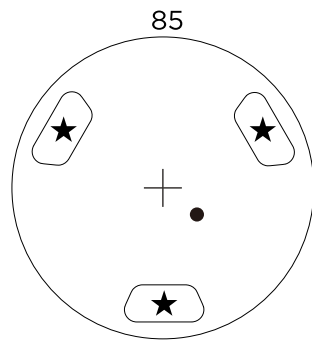
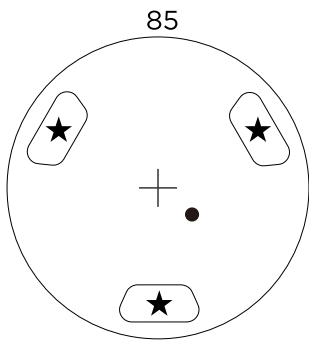

93

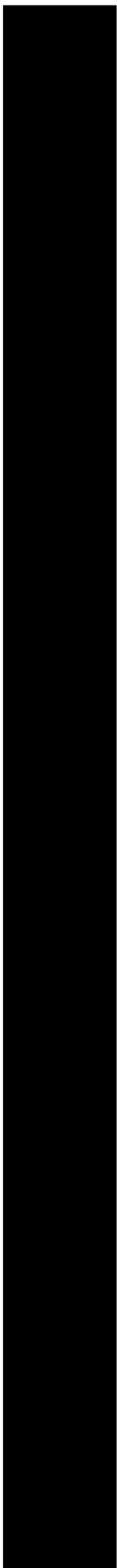

93



93

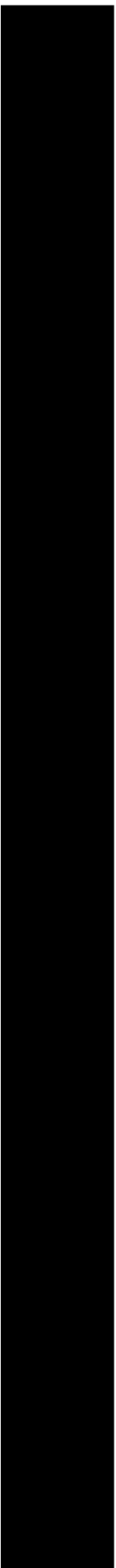

93

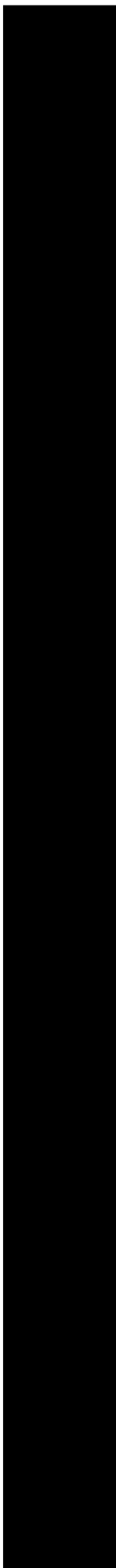

94



94



95



95



95



95



96



96



97

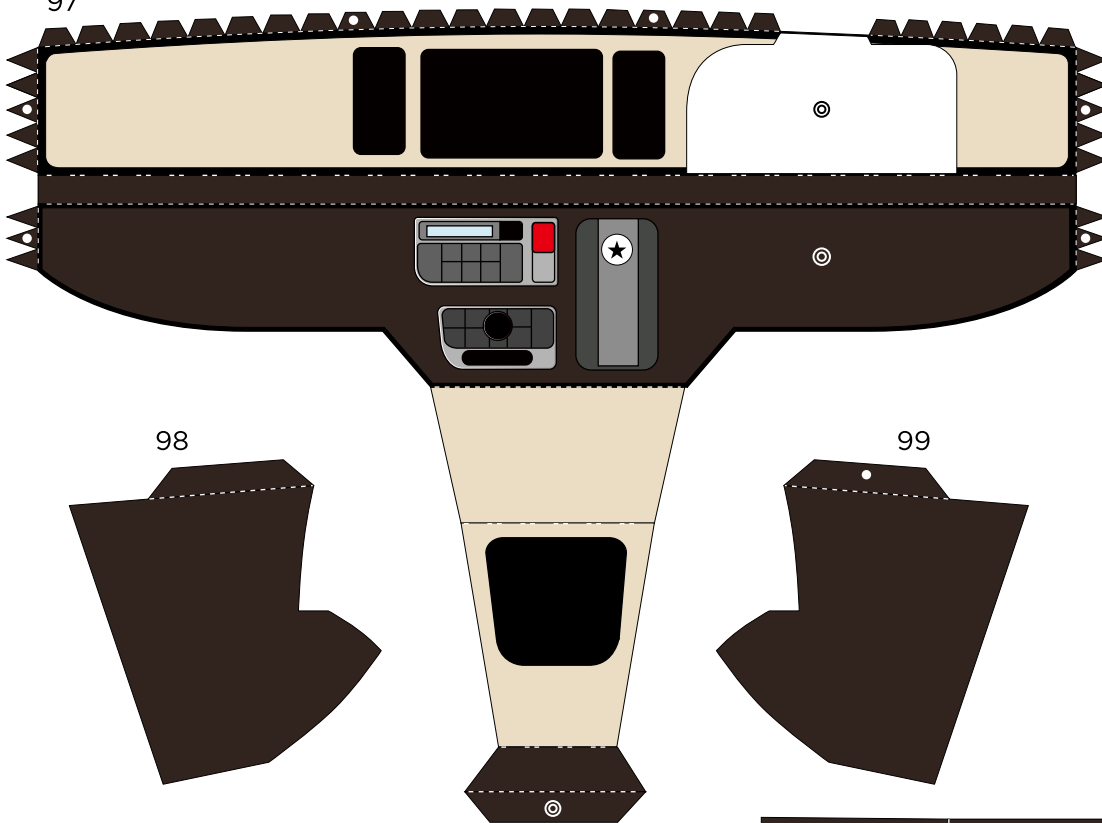

100



102



98

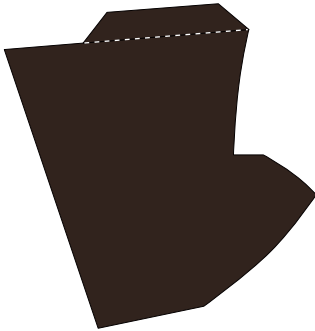

99

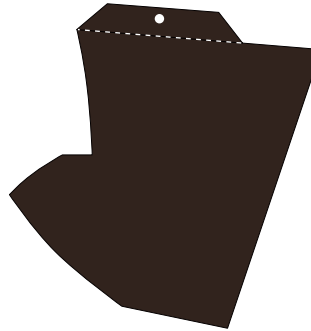

103



104



107



108

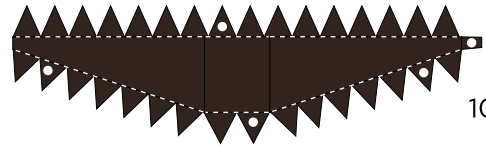

109



110

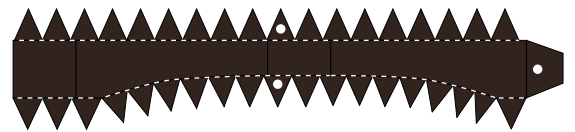

111

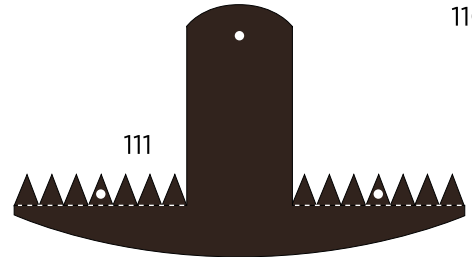

112

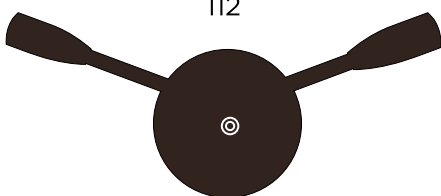

113

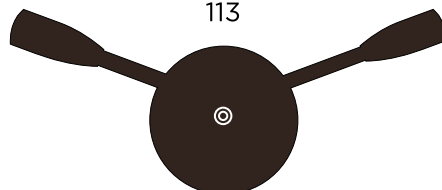

114

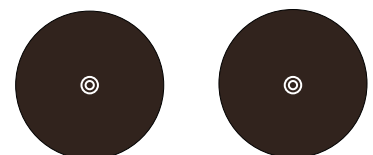

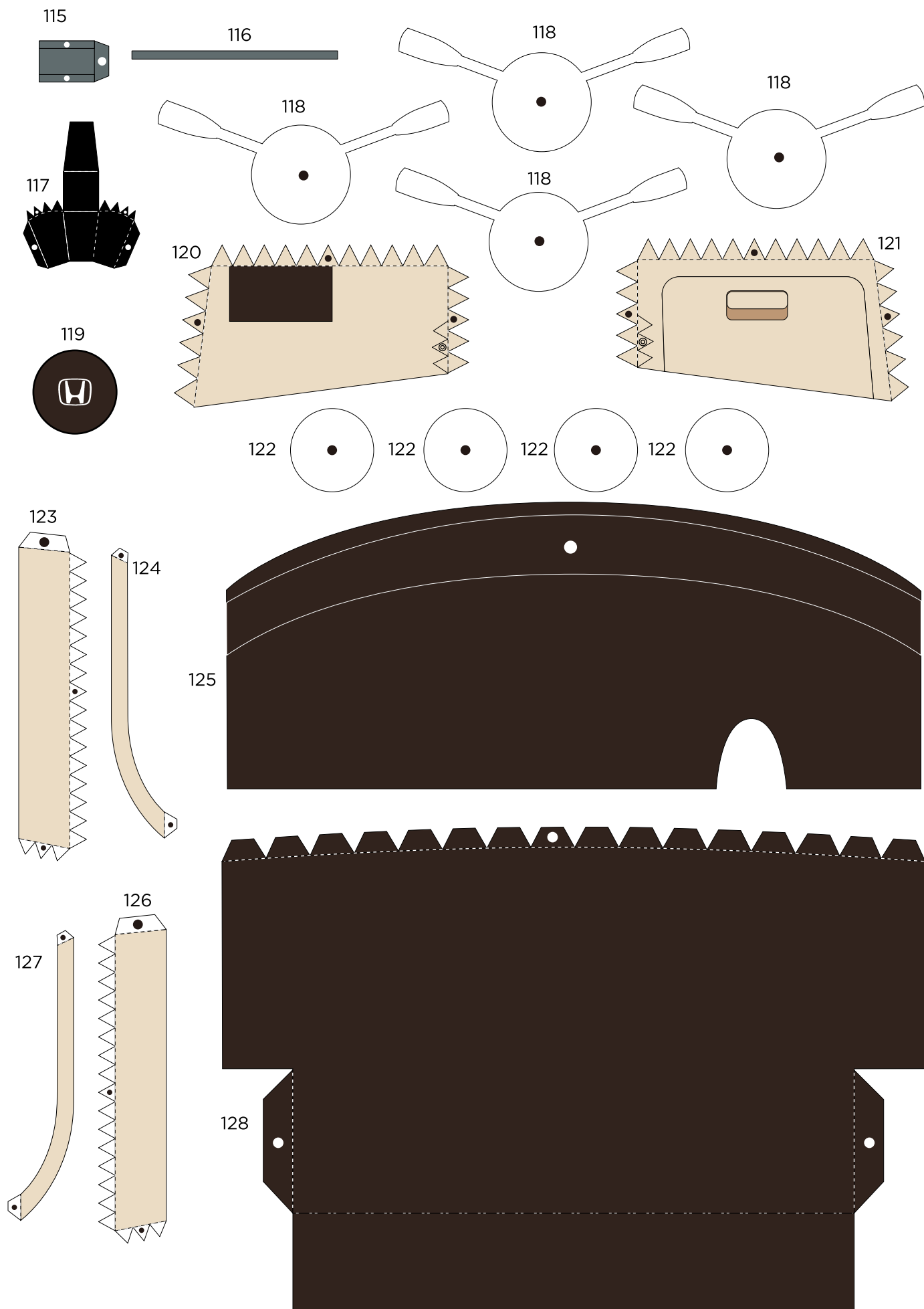

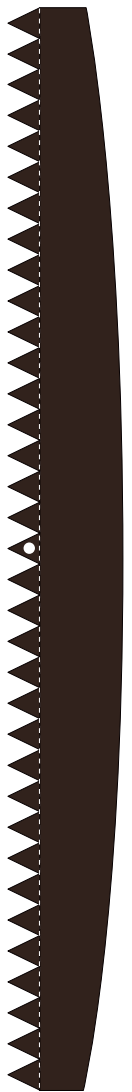
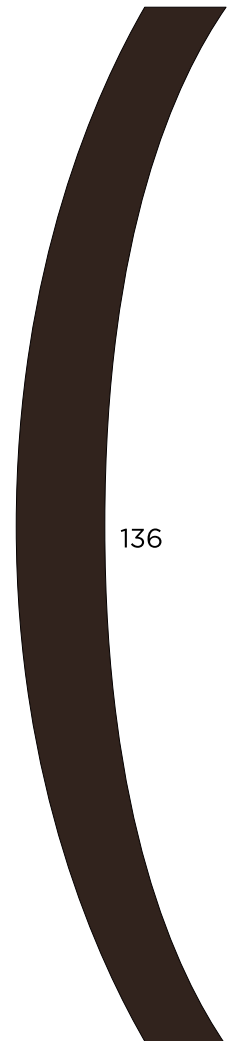
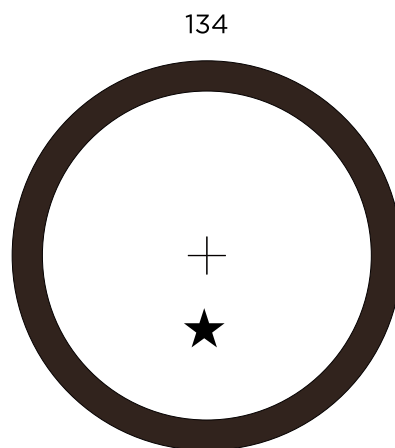
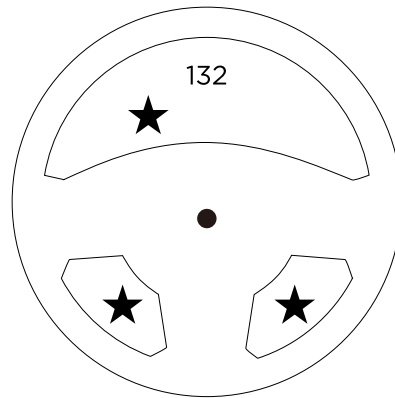
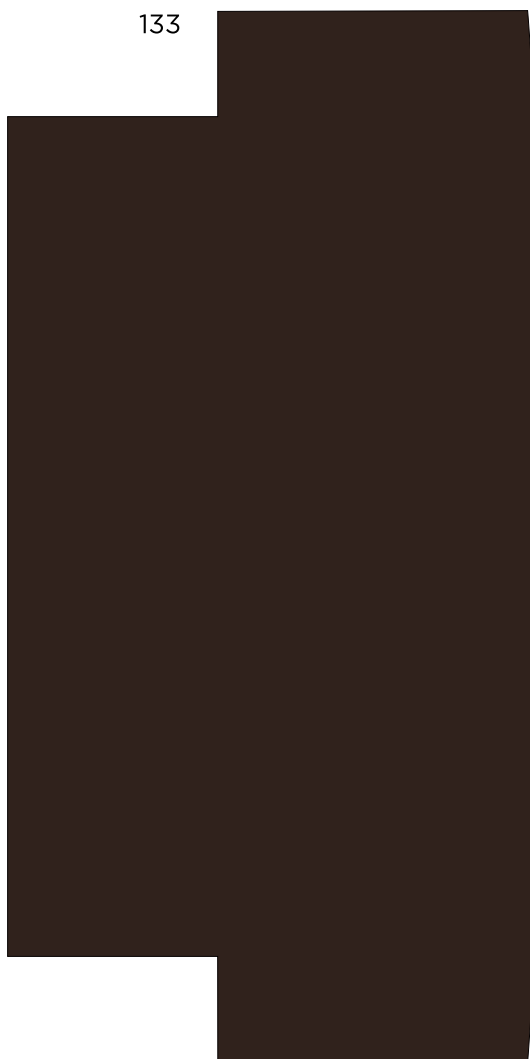
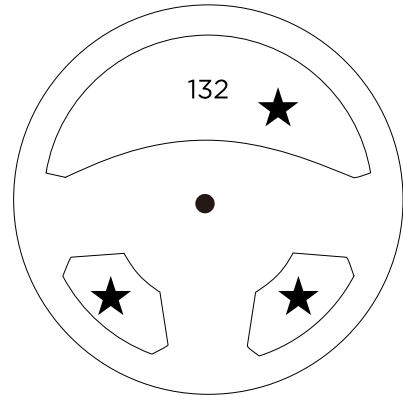
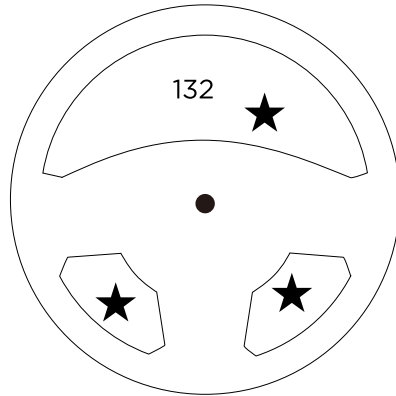
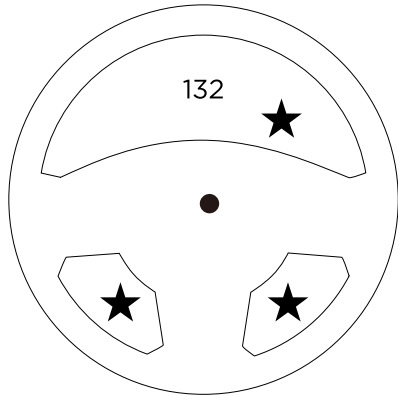
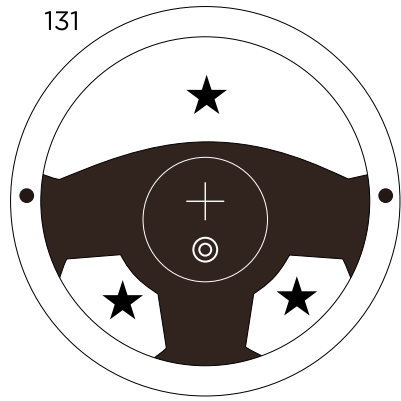
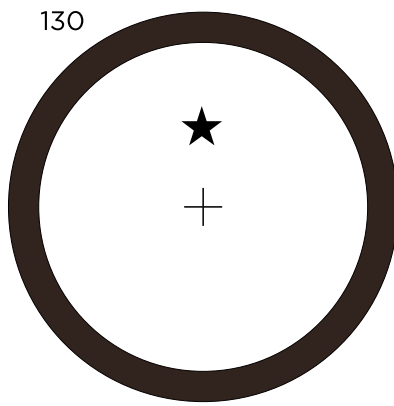
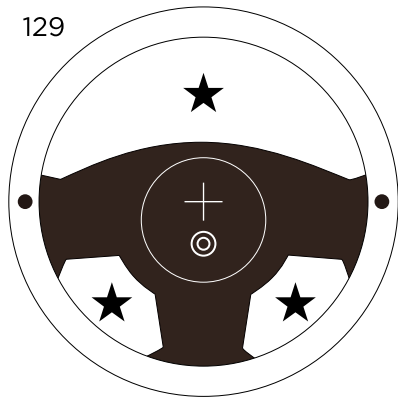

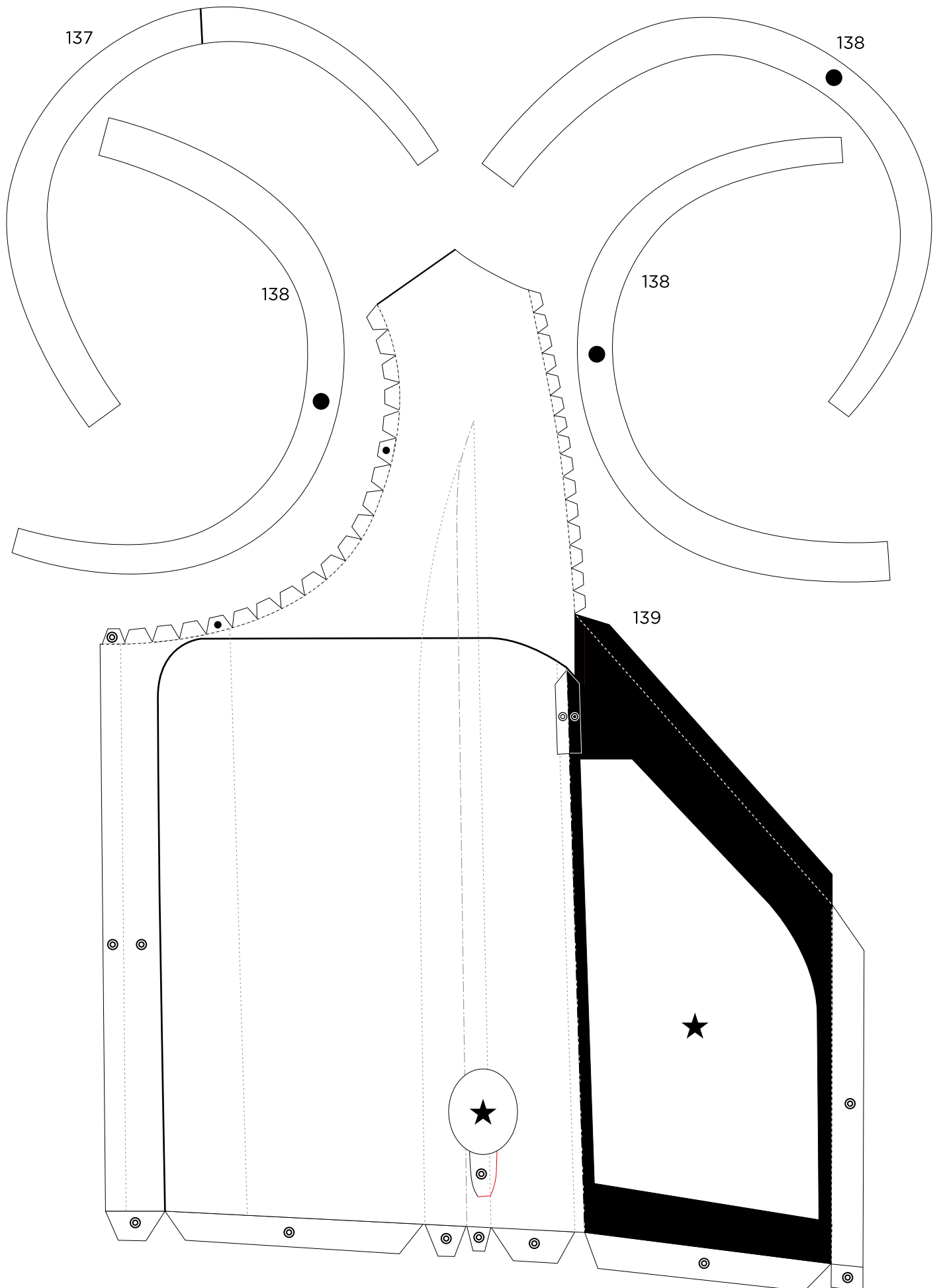



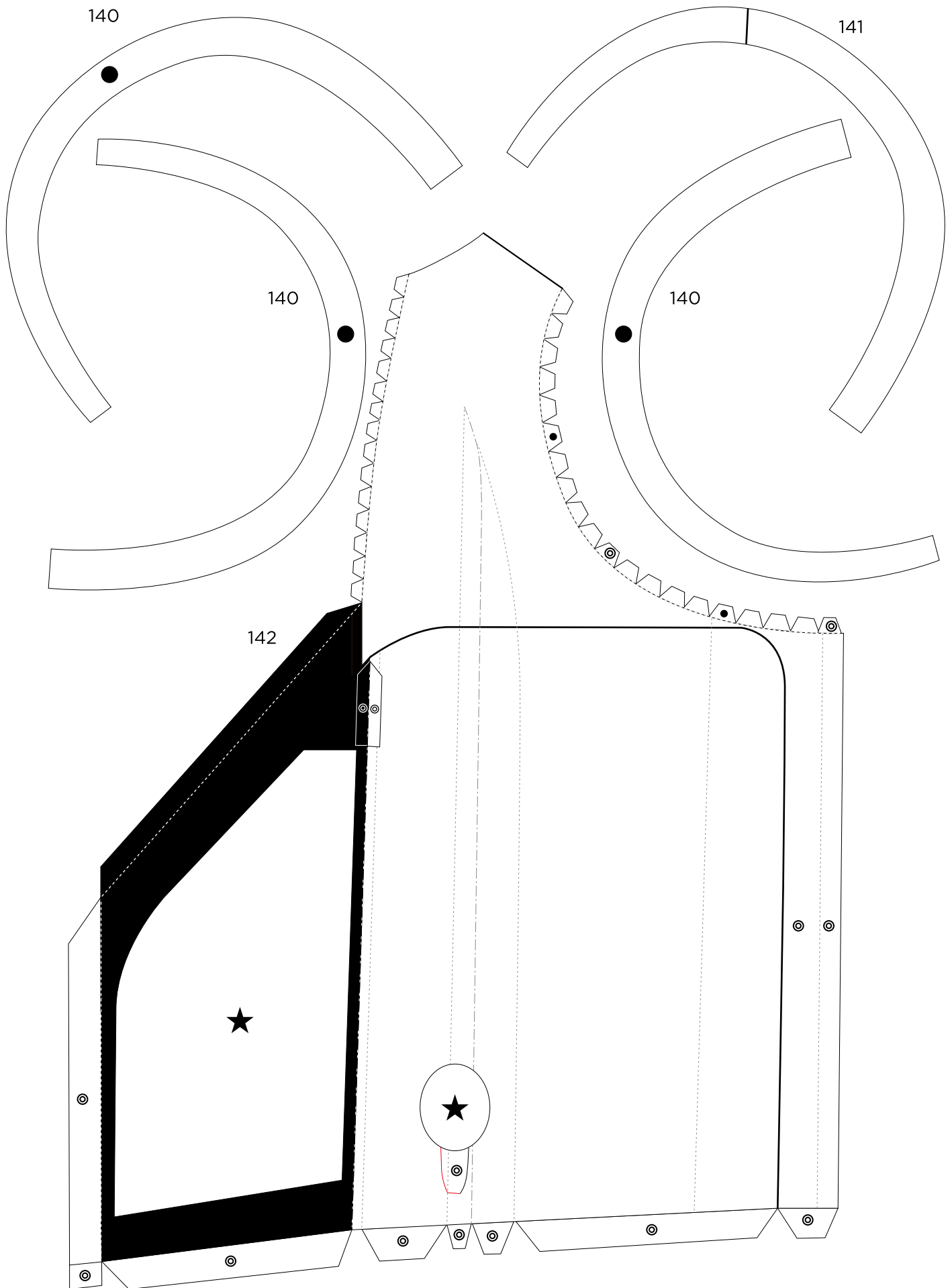

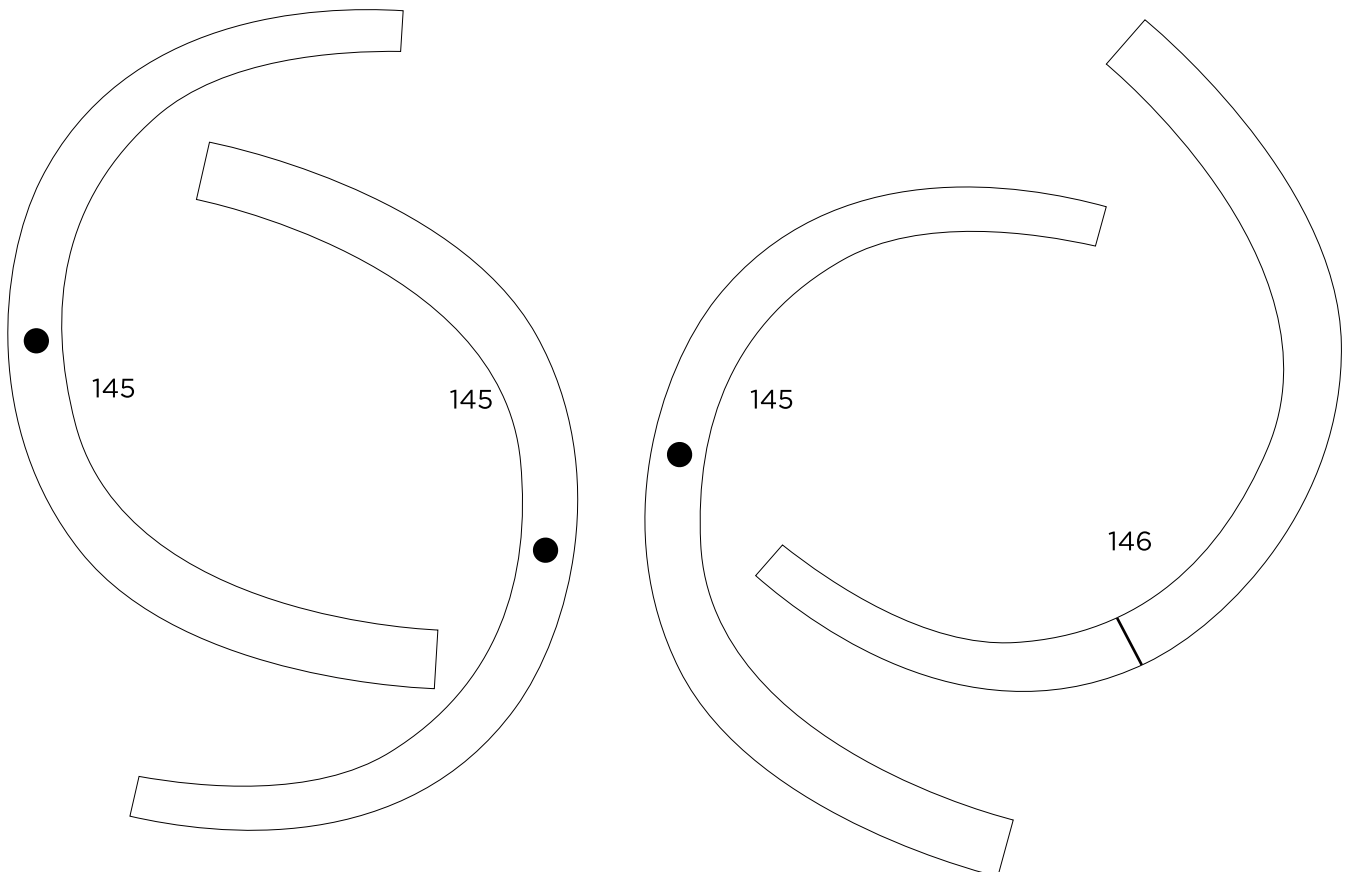
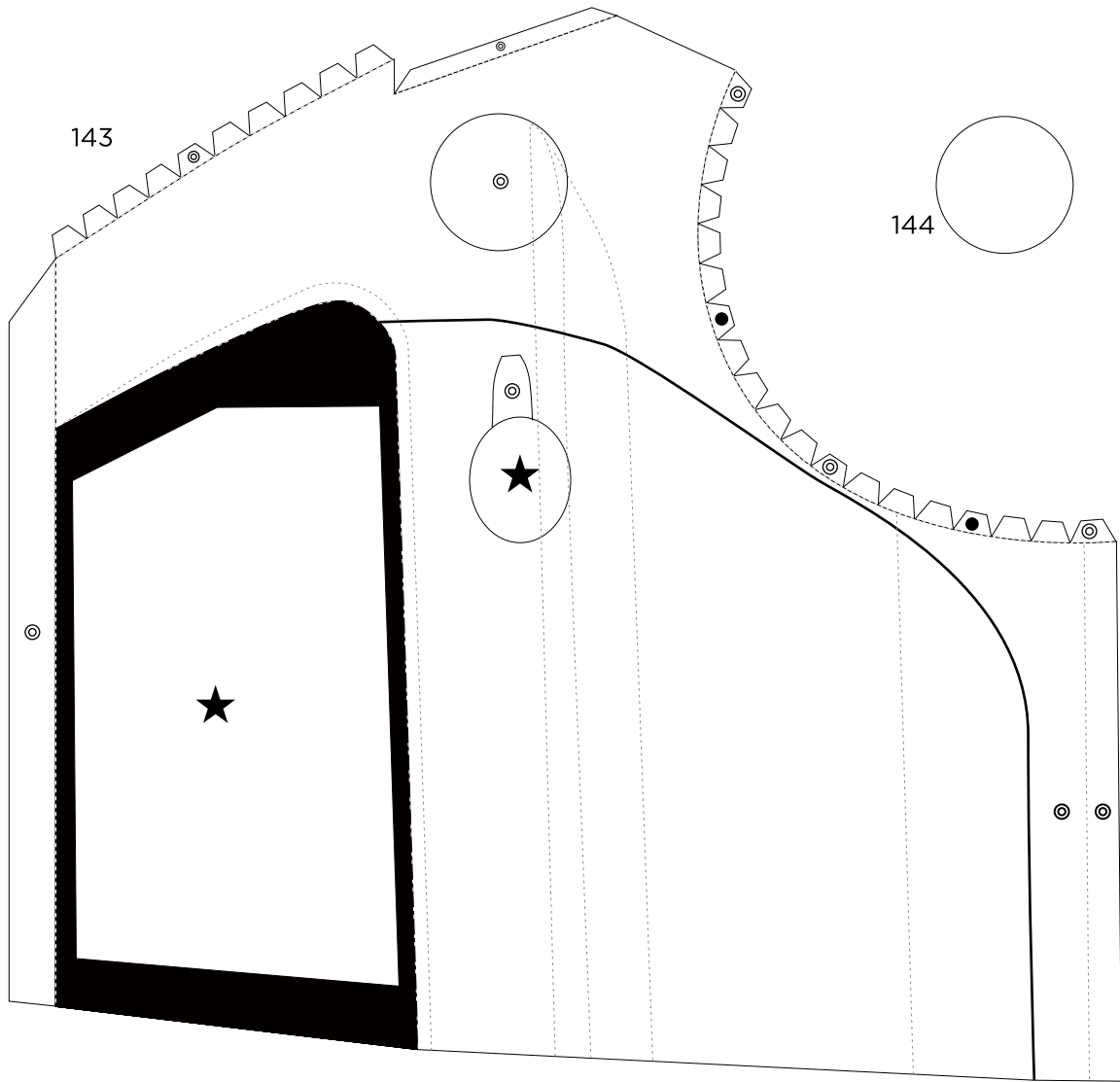

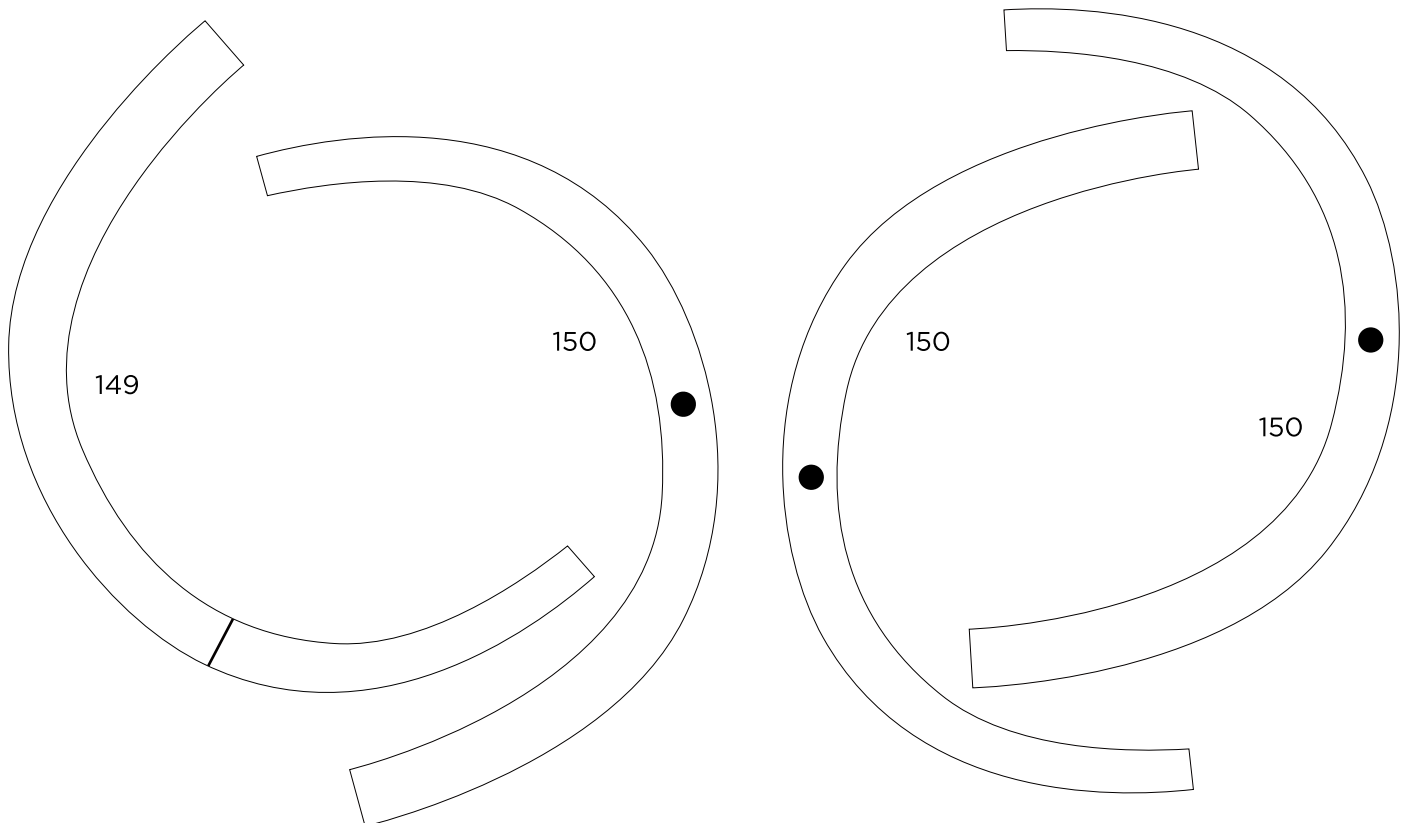
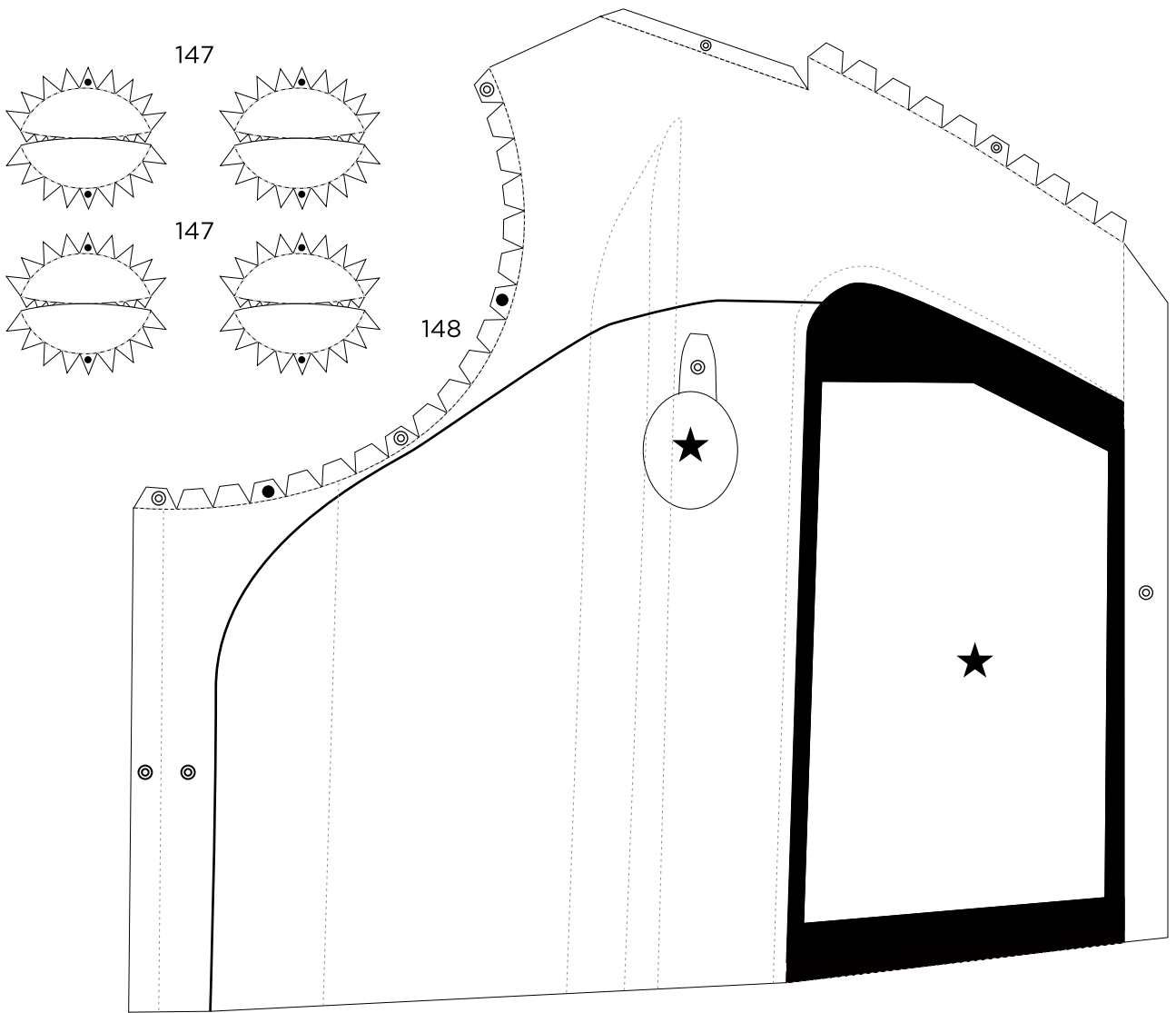

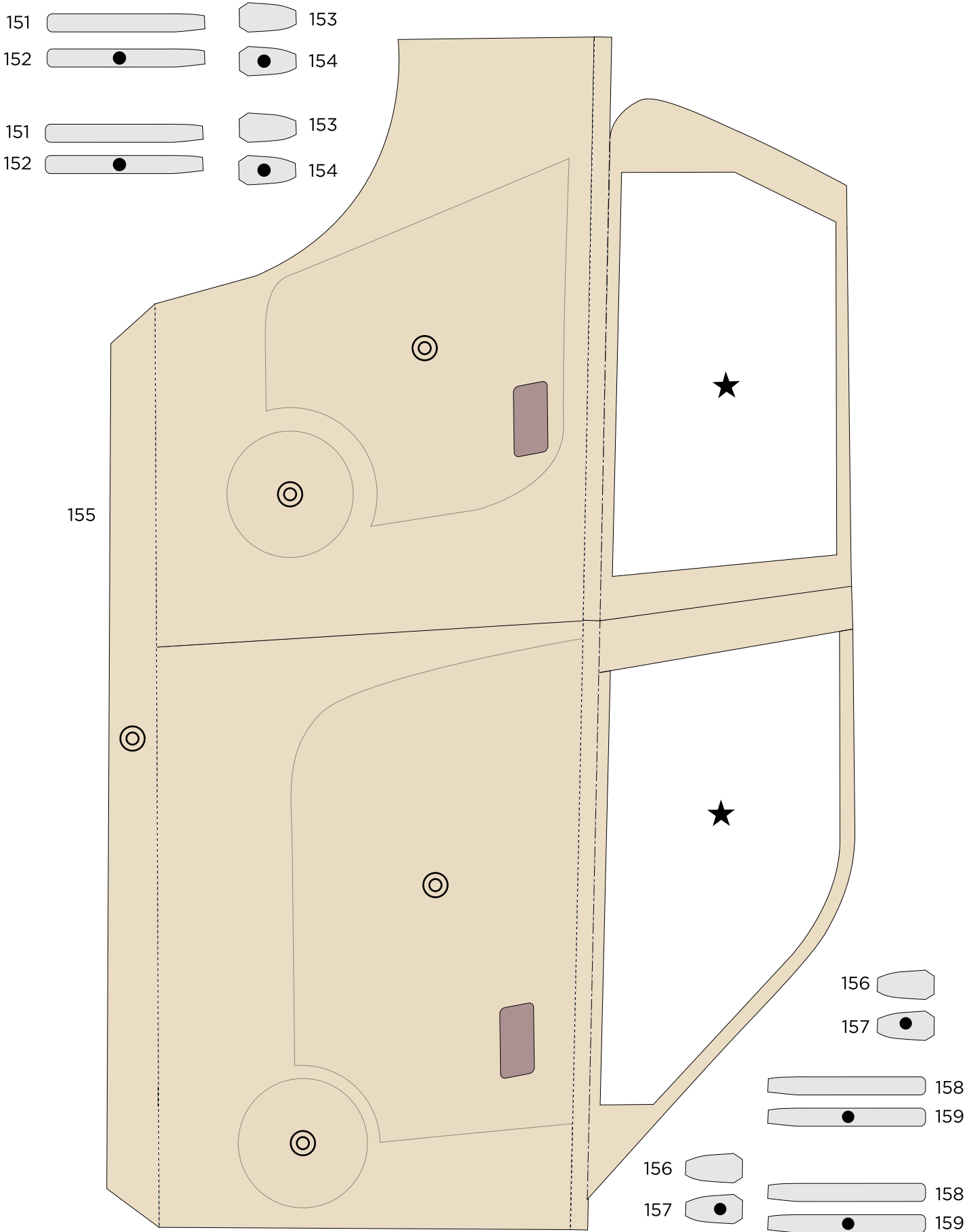

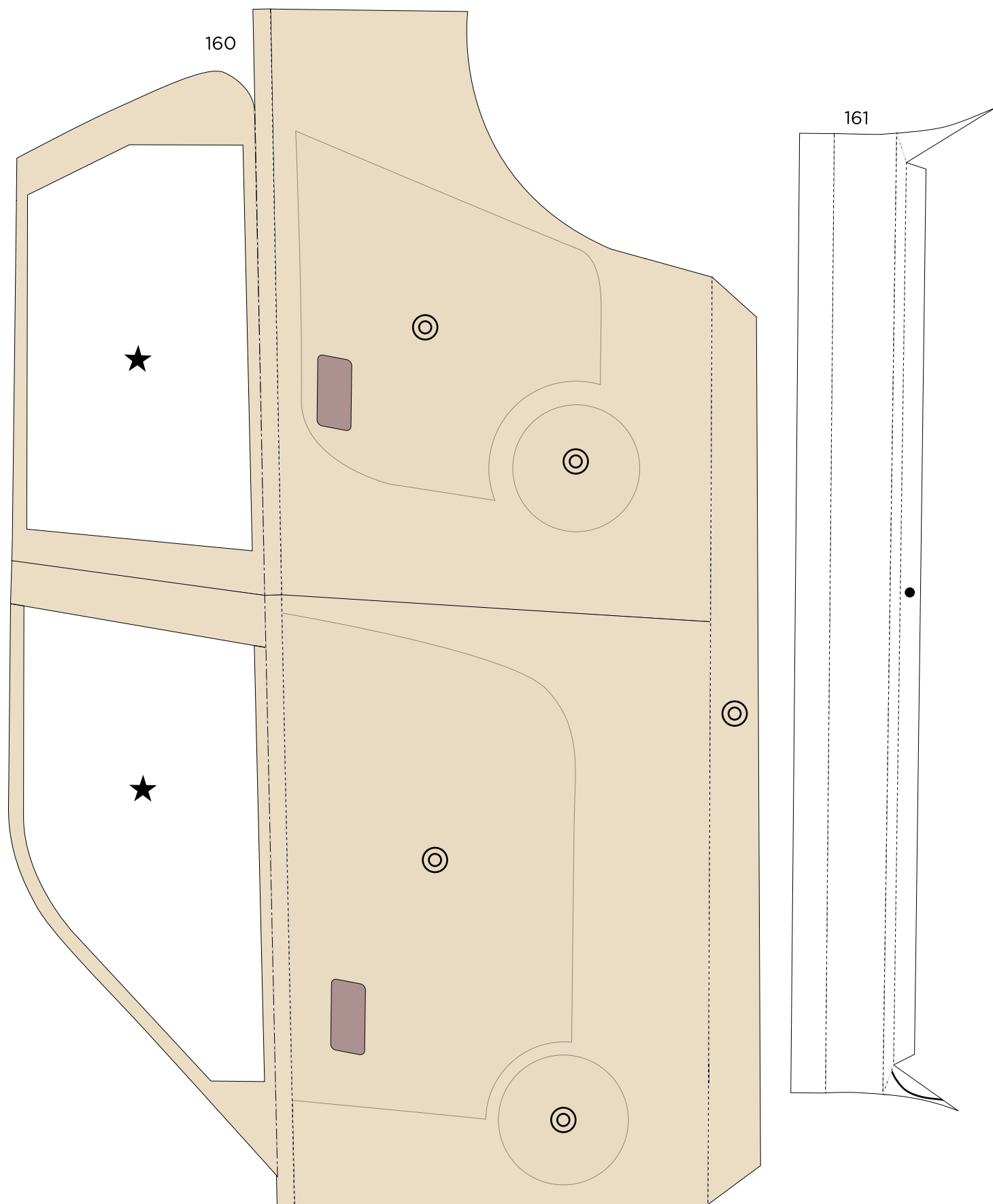

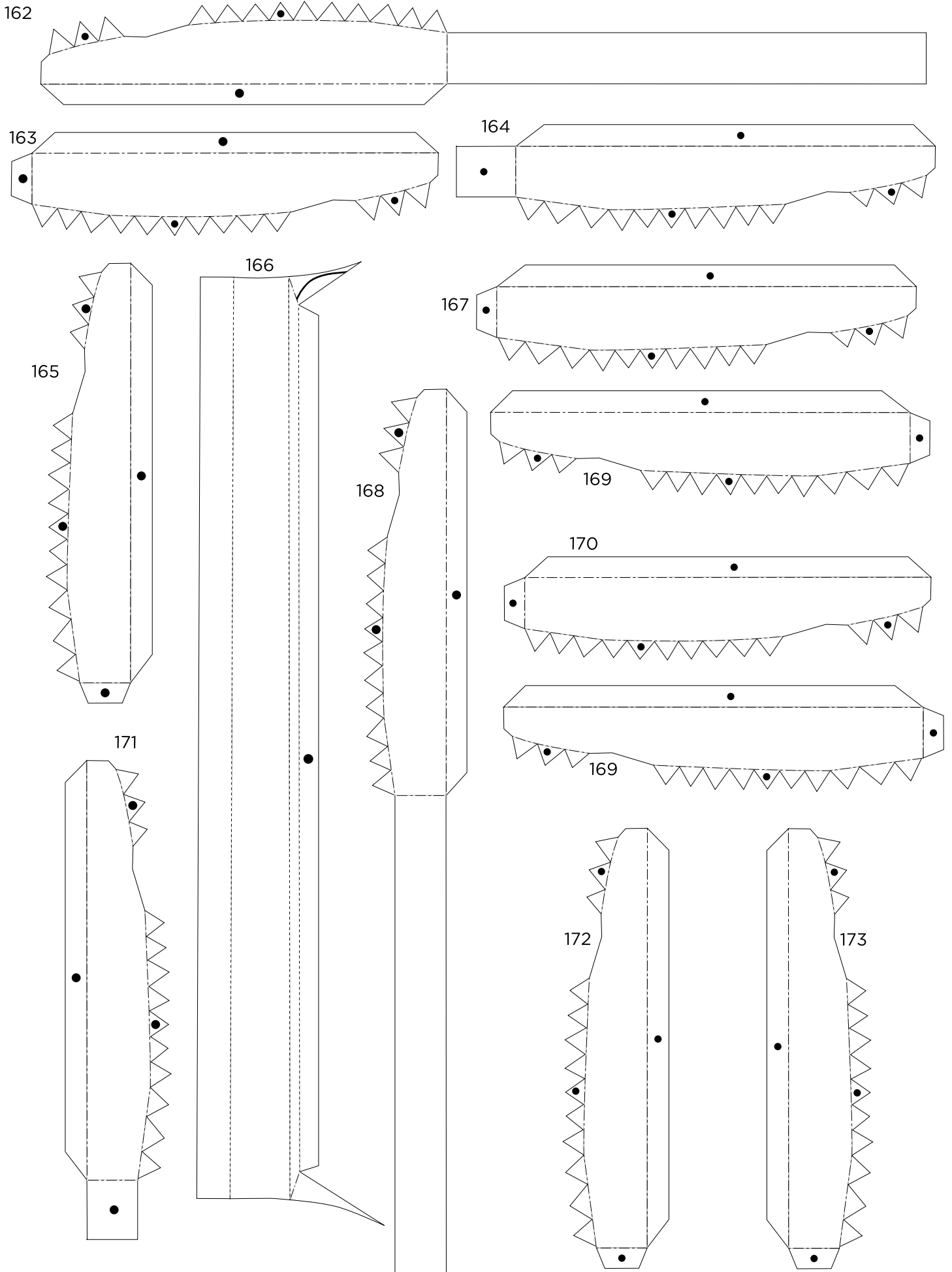

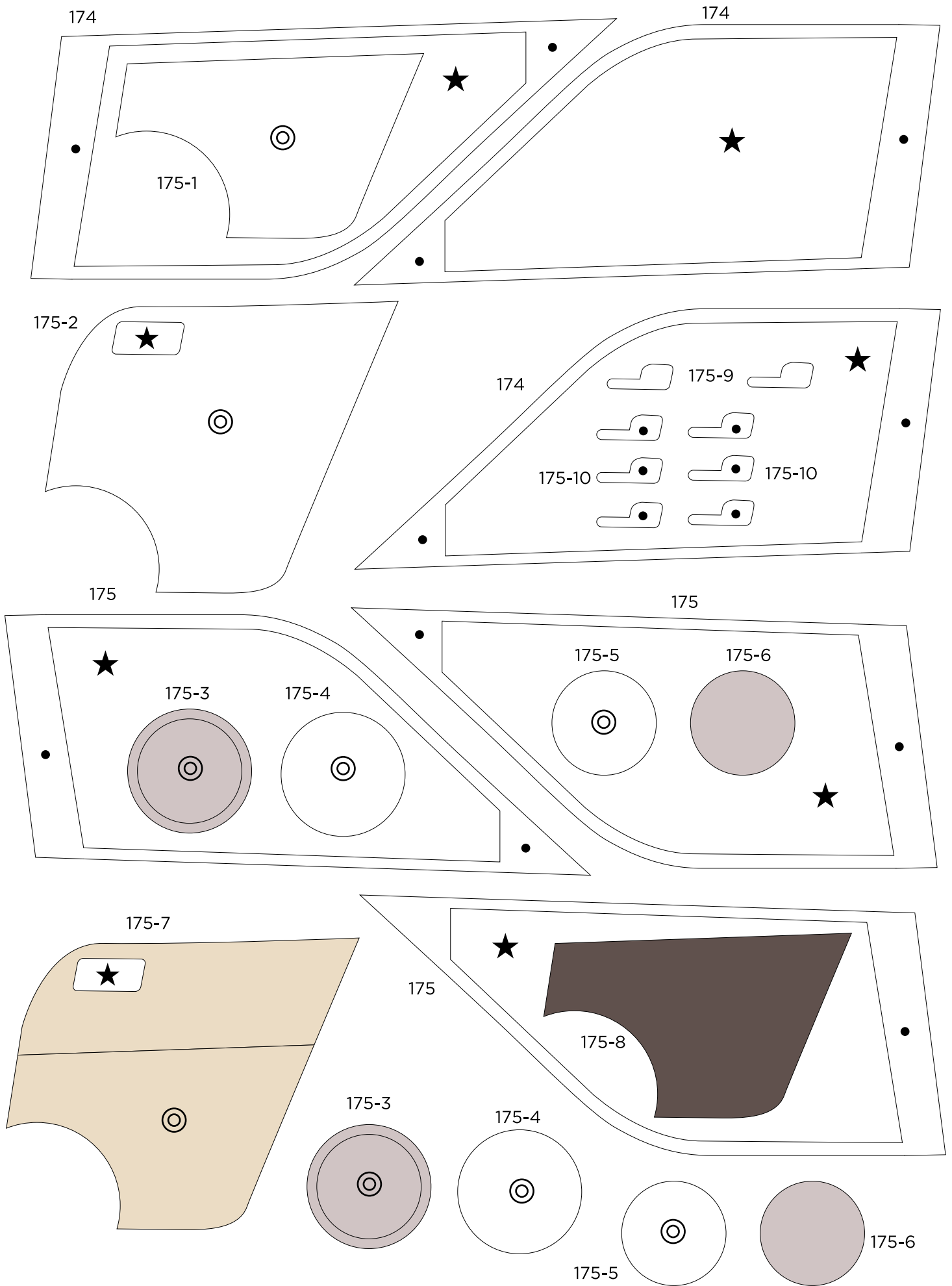

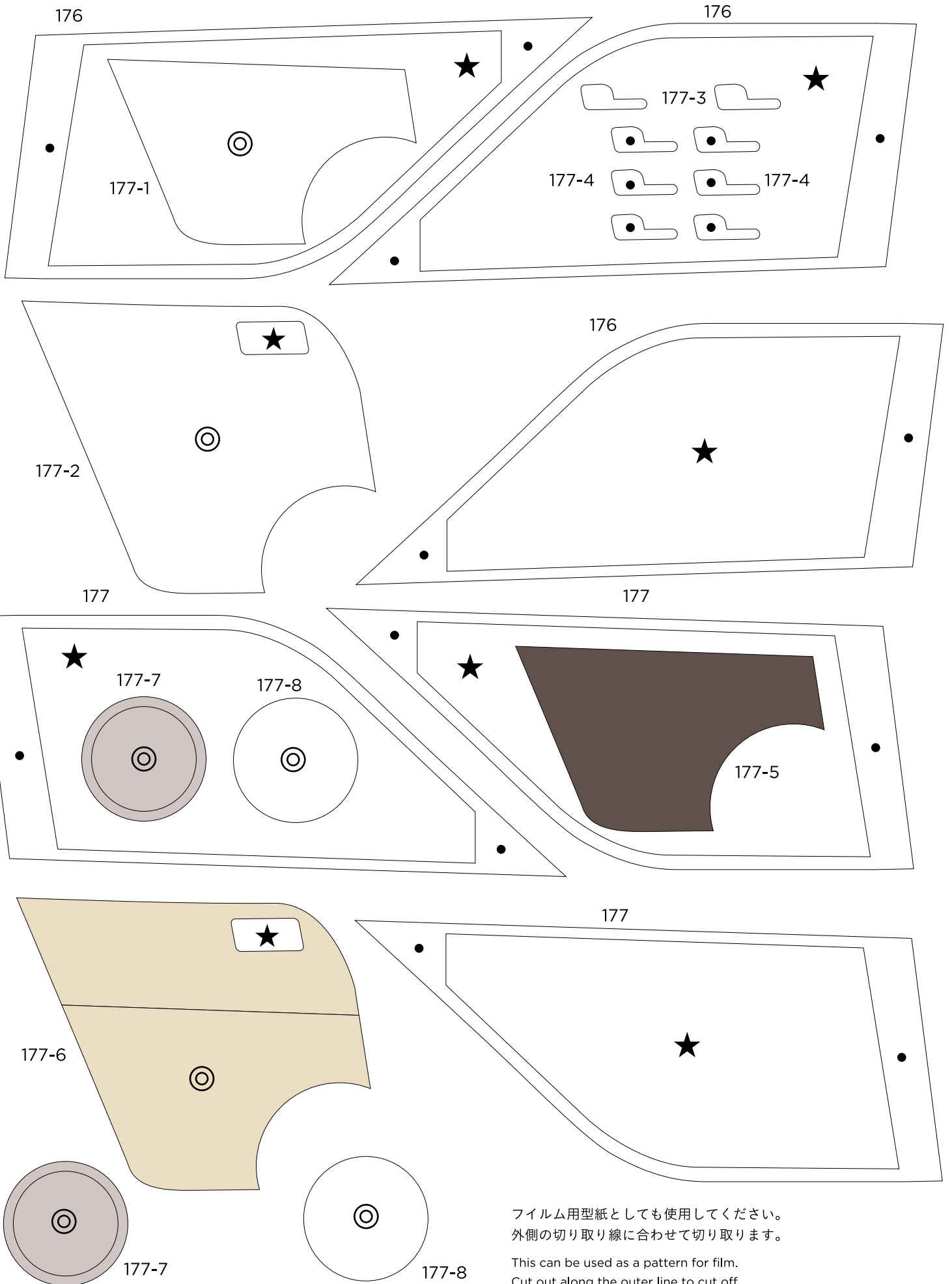

フィルム用型紙としても使用してください。  
外側の切り取り線に合わせて切り取ります。

This can be used as a pattern for film.  
Cut out along the outer line to cut off.



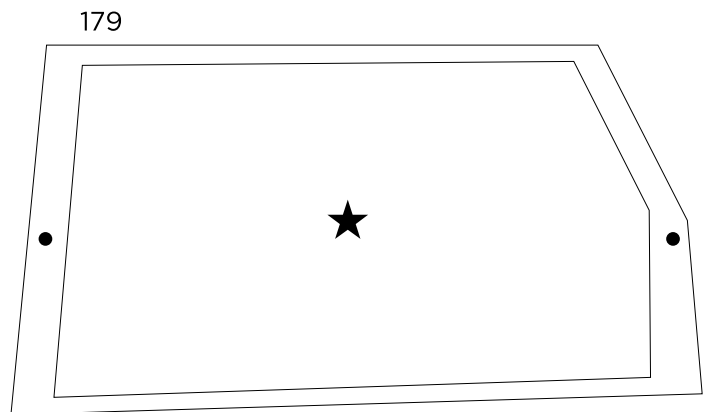
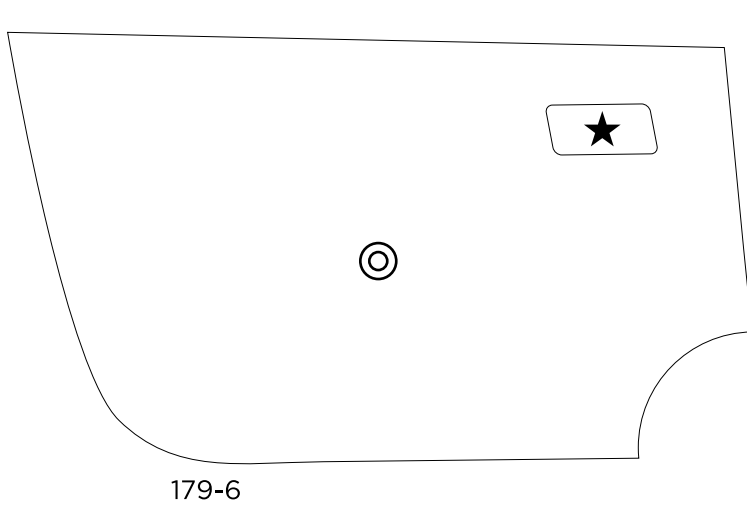
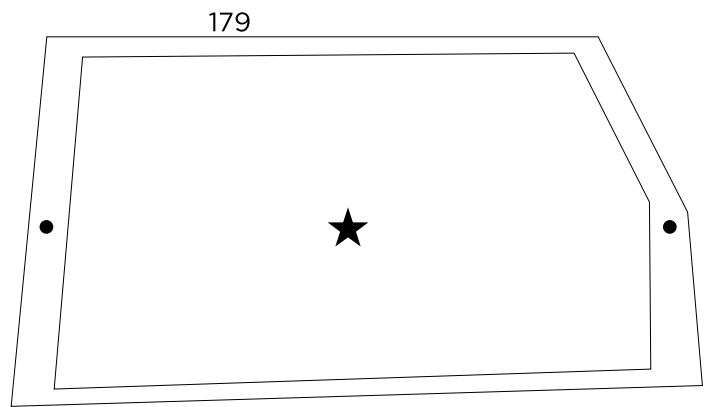
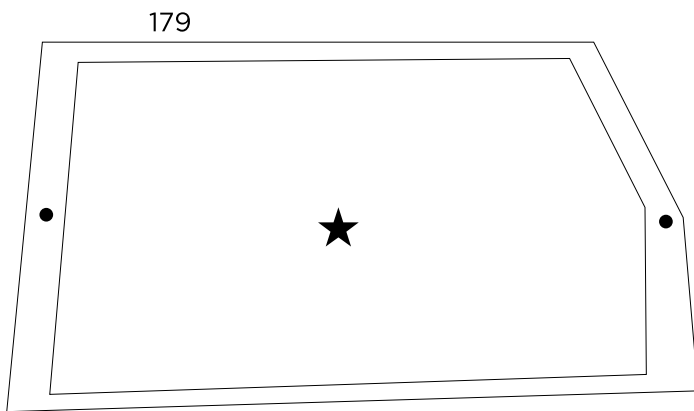
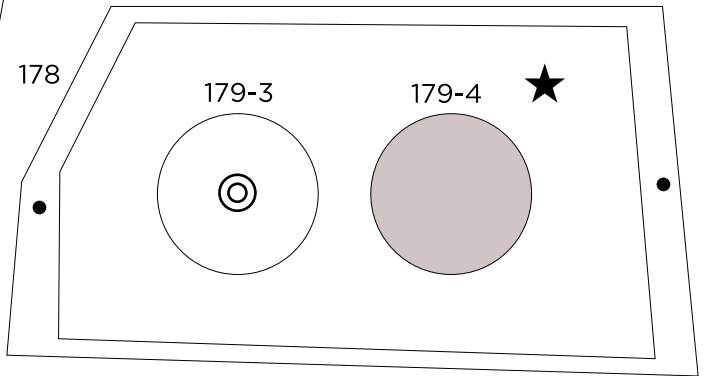
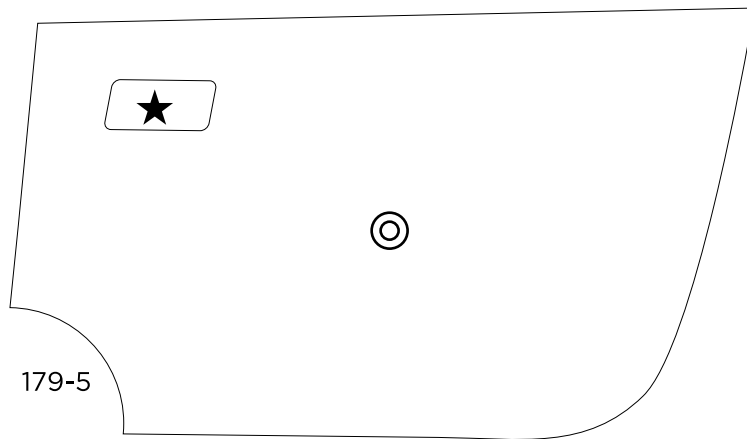
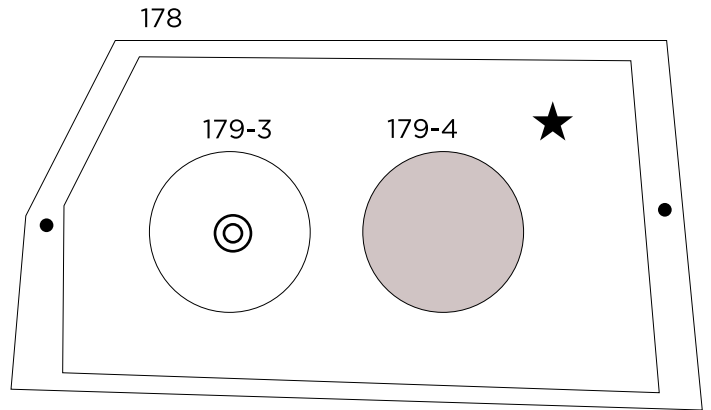
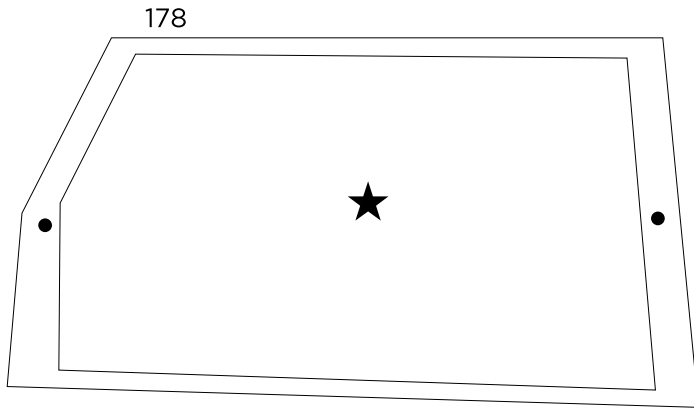

180

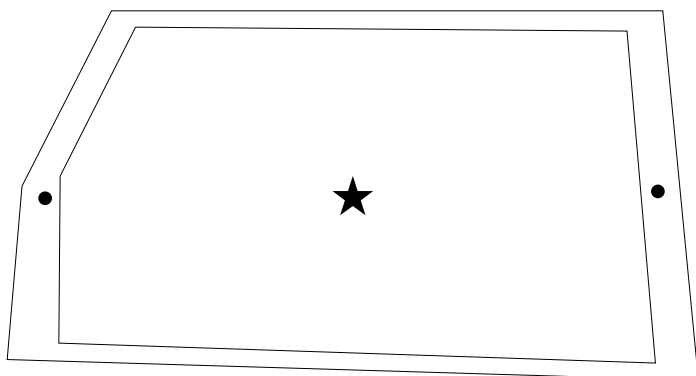

180

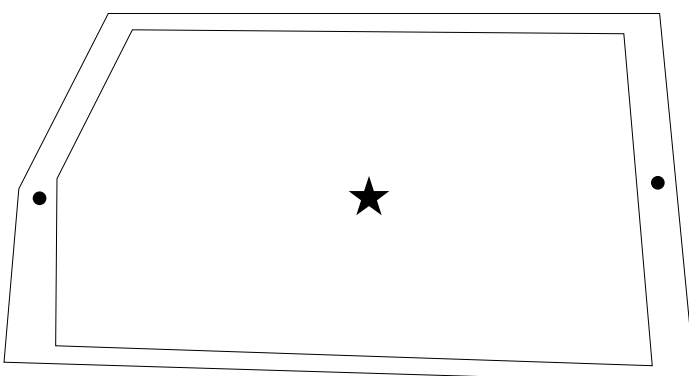

181-1

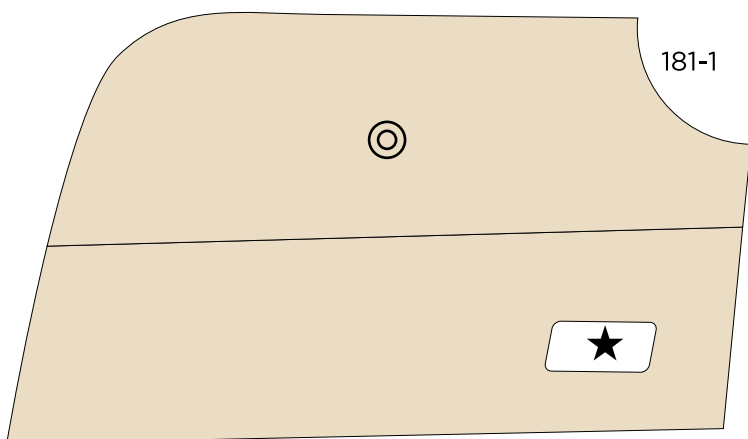

180

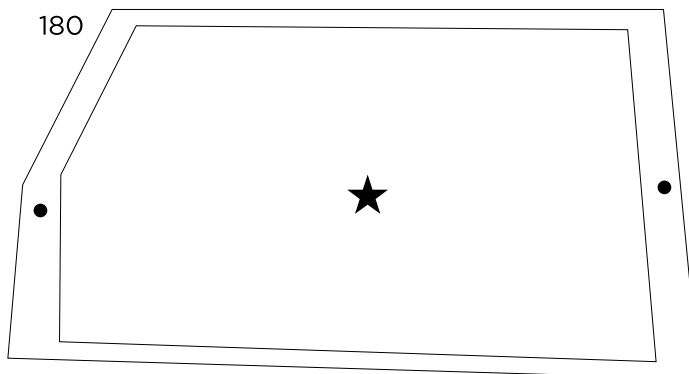

181

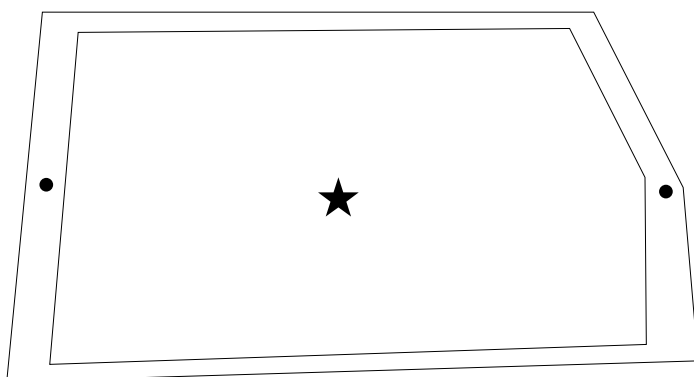

181

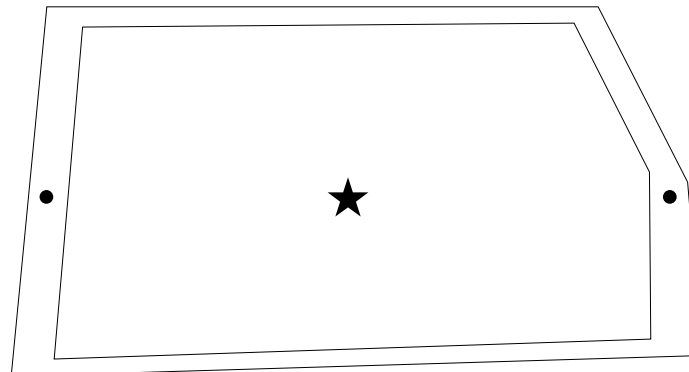

181-2

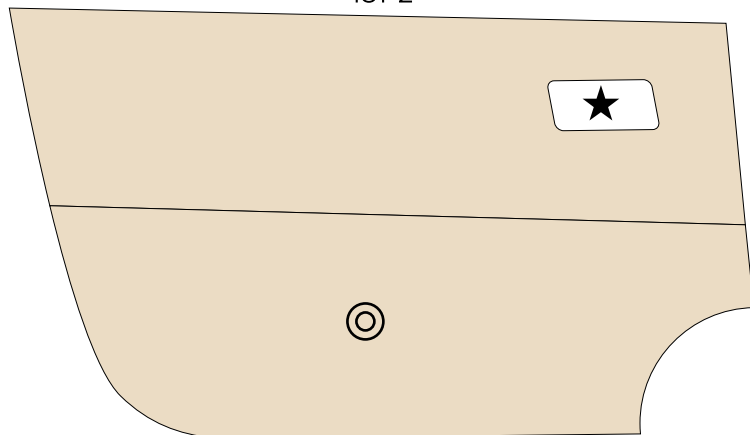

181

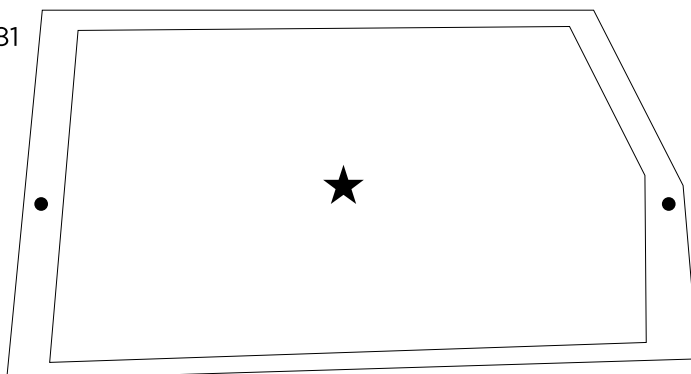

フィルム用型紙としても使用してください。  
外側の切り取り線に合わせて切り取ります。

This can be used as a pattern for film.  
Cut out along the outer line to cut off.

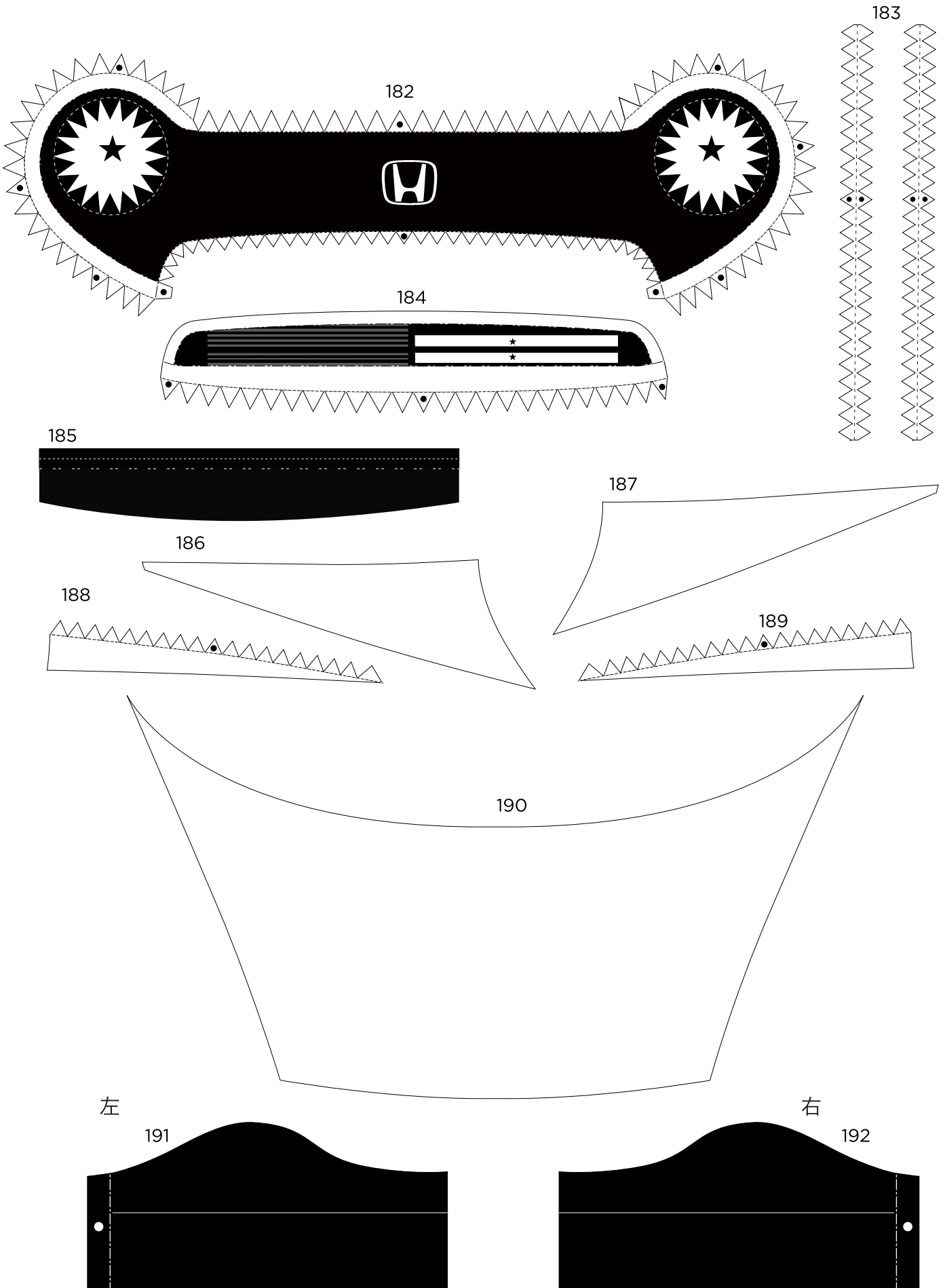

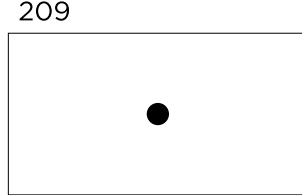
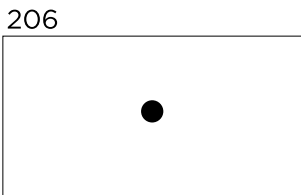
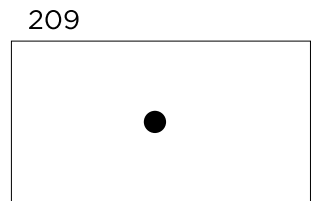
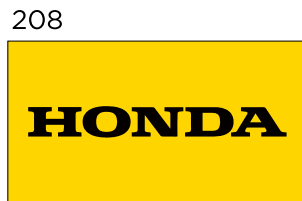
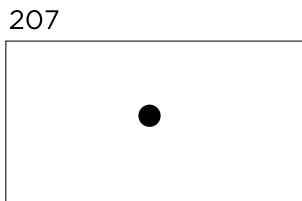
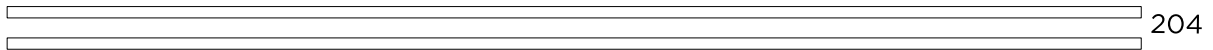
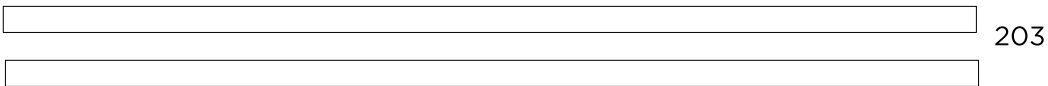
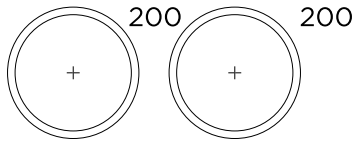
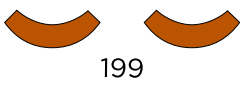
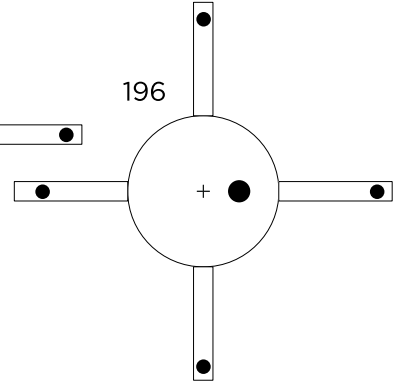
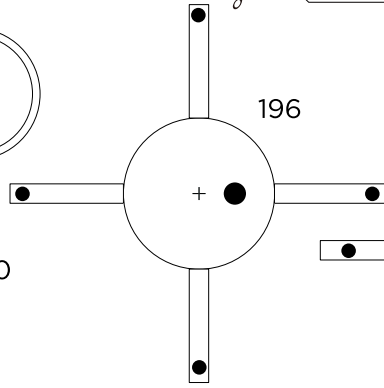
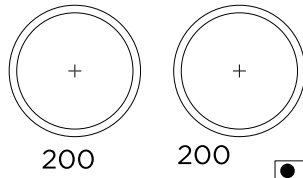
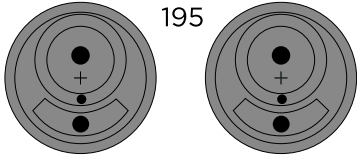
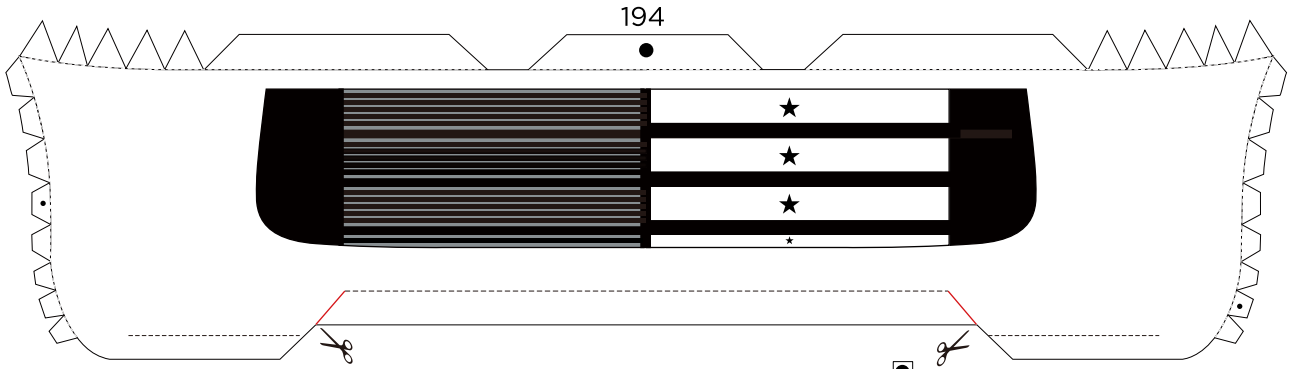
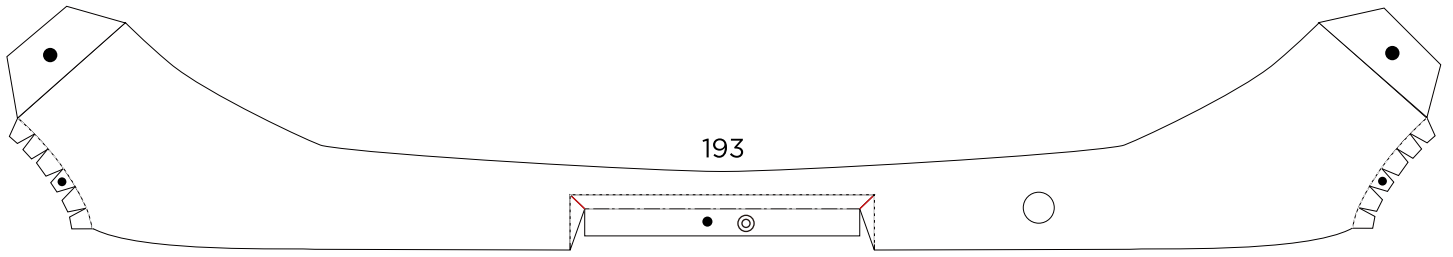

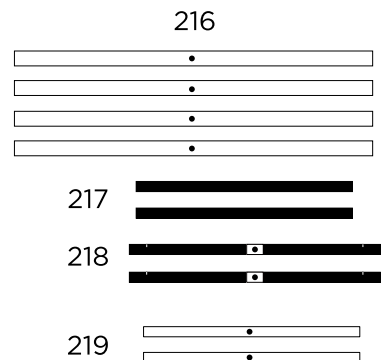
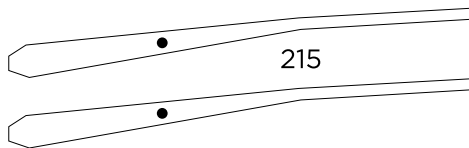
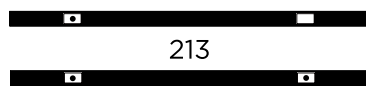
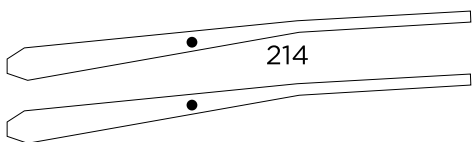
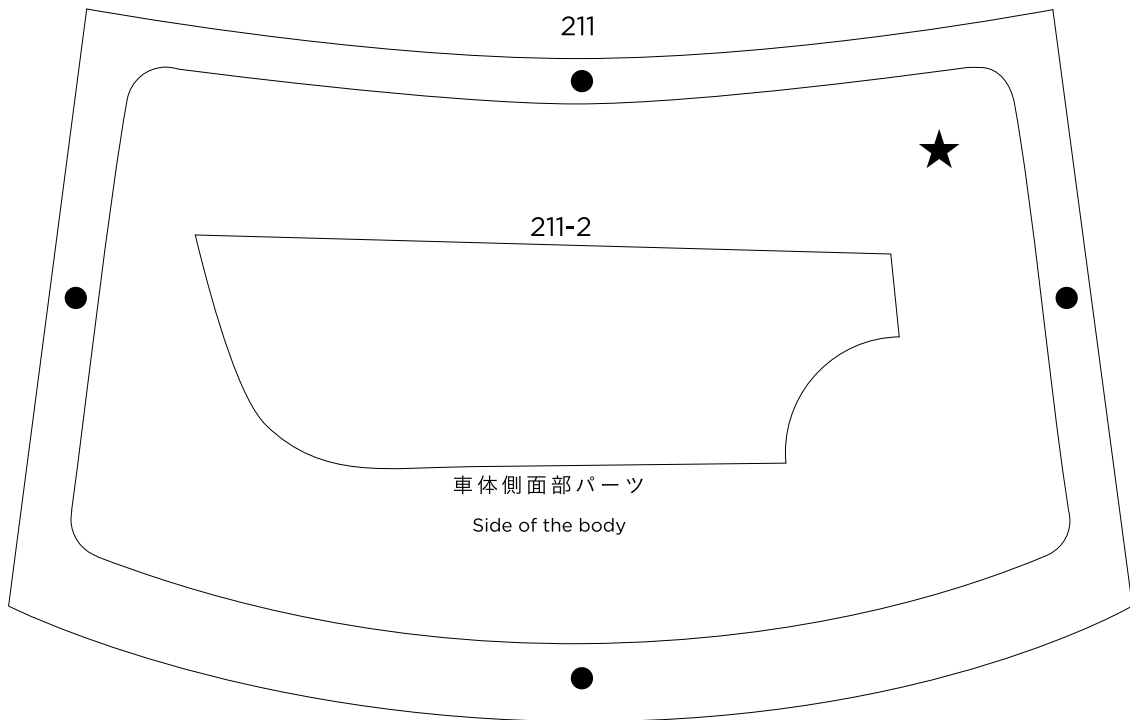
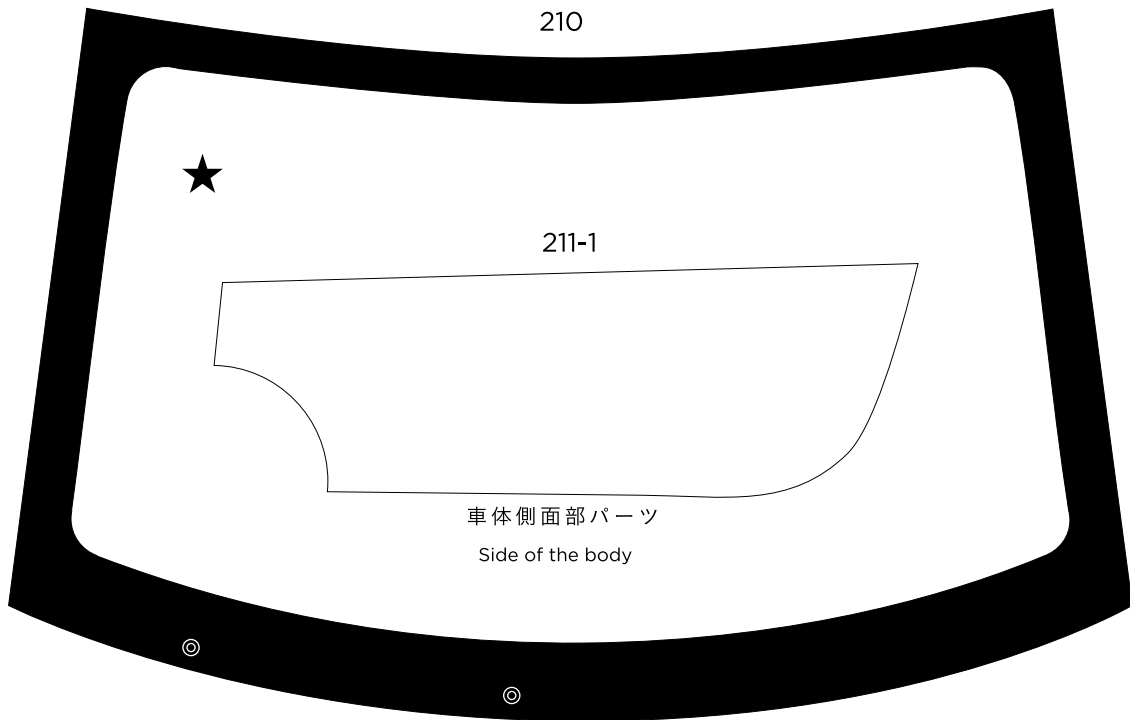

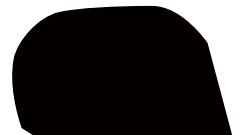
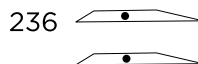
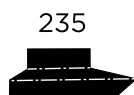
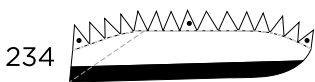
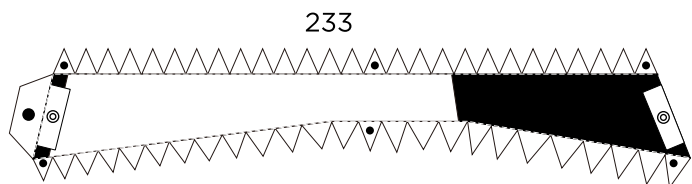
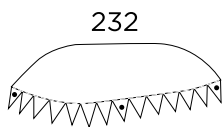
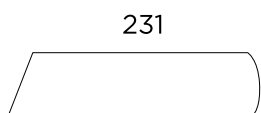
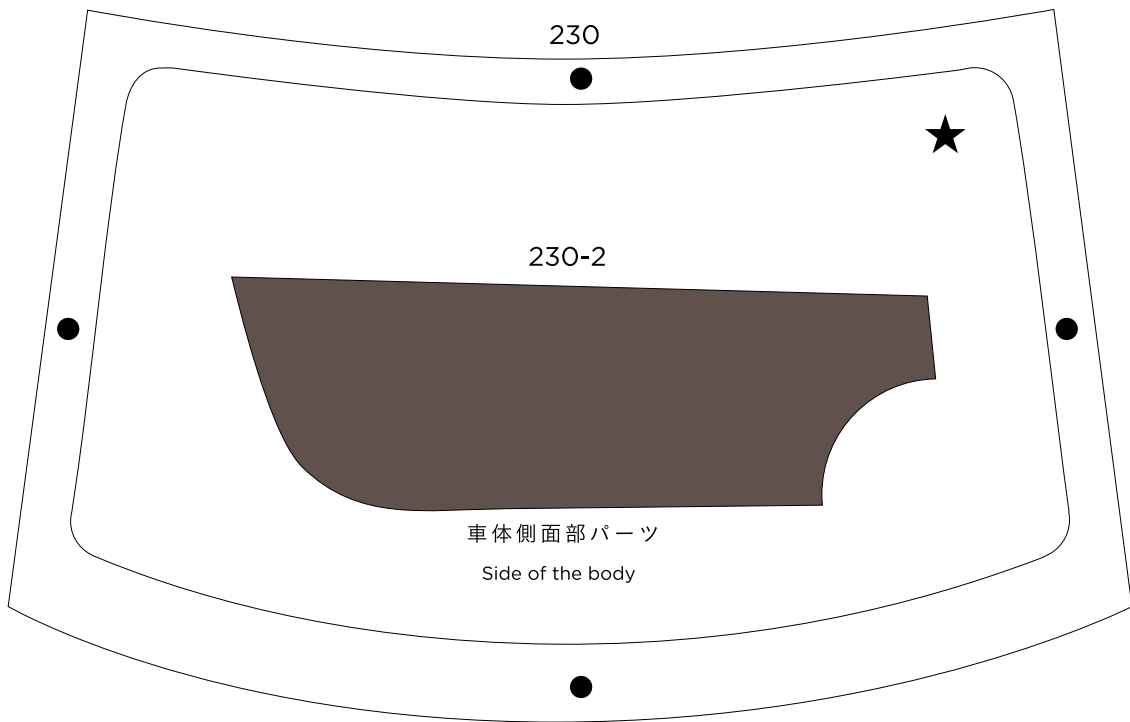
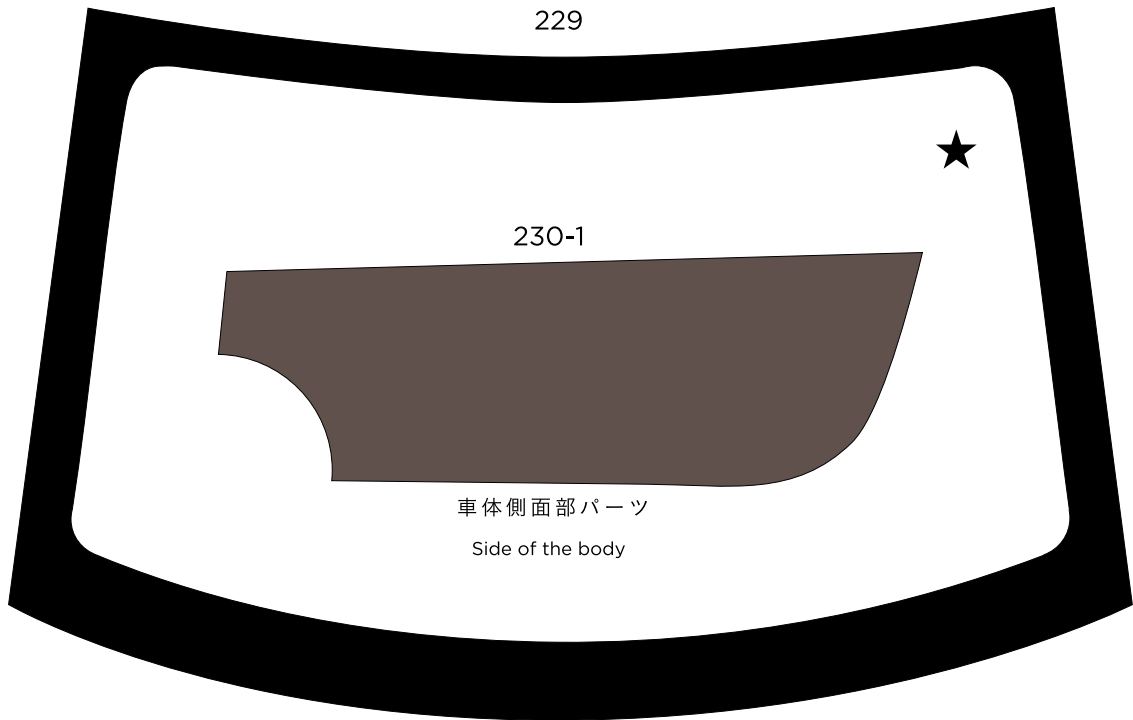

238

